

Contents

Introduction.....	4
PICAXE Software.....	4
Labels.....	5
Comments.....	5
Constants.....	6
Symbols.....	6
Directives.....	7
Variables - General.....	10
Variables - Storage.....	11
Variables - Scratchpad.....	12
Variables - System.....	13
Variables - Special function.....	14
Variables - Mathematics.....	22
Variables - Unary Mathematics.....	25
Input / Output Pin Naming Conventions.....	27
adcconfig.....	28
adcsetup.....	29
backward.....	34
bcdtoascii.....	35
bintoascii.....	36
booti2c.....	37
branch.....	39
button.....	40
calibadc (calibadc10).....	42
calibfreq.....	43
clearbit.....	44
compsetup.....	45
count.....	50
daclevel.....	51
dacsetup.....	52
debug.....	54
dec.....	55
disablebod.....	56
disabletime.....	57
disconnect.....	58
do...loop.....	59
doze.....	60
eprom (data).....	61
enablebod.....	62
enabletime.....	63
end.....	64
exit.....	65
for...next.....	66
forward.....	67
fvrsetup.....	68
get.....	69
gosub (call).....	70
goto.....	71
hi2cin.....	72
hi2cout.....	74
hi2csetup.....	76
hi2csetup - slave mode (X2 parts only).....	76
hi2csetup - master mode.....	78
halt.....	80
hibernate.....	81
high.....	83
high portc.....	84
hintsetup.....	85
hpwm.....	86

hpwmduty	90
hserin	91
hserout	93
hsersetup	94
hspiin (hshin)	96
hspiout (hshout)	97
hspisetup	98
i2cslave	102
if...then \ elseif...then \ else \ endif	104
if...then {goto}	106
if...and/or...then {goto}	106
if porta...then {goto}	107
if portc...then {goto}	107
if...then exit	108
if...and/or...then exit	108
if...then gosub	109
if...and/or...then gosub	109
inc	111
infrain	112
infrain2	114
infraout	115
input	120
inputtype	121
irin	125
irout	127
kbin	129
keyin	131
kbled (keyled)	133
let	134
let dirs / dirsc =	136
let dirsA / dirsB / dirsC / dirsD =	137
let pins / pinsc =	138
let pinsA / pinsB / pinsC / pinsD =	139
lookdown	140
lookup	141
low	142
low portc	143
nap	144
on...goto	145
on...gosub	146
output	147
owin	148
owout	149
pause	150
pauseus	151
peek	152
peeksr	154
play	155
poke	156
pokesr	158
pullup	159
pulsin	160
pulsout	161
put	162
pwm	163
pwm duty	164
pwmout	165
random	168
read	169
readadc	170
readadc10	171
readdac	172
readdac10	173
readi2c	174
readinternaltemp	175

readfirmware	177
readmem	178
readtable	179
readoutputs	180
readportc	181
readrevision	182
readsilicon	183
readtemp	184
readtemp12	185
readowclk	186
resetowclk	187
readown	188
reconnect	190
reset	191
restart	192
resume	193
return	194
reverse	195
rfin	196
rfout	198
run	200
select case \ case \ else \ endselect	203
serin	204
serrxd	207
serout	208
sertxd	210
servo	211
servopos	213
setbit	214
setint	215
setintflags	219
setfreq	221
settimer	223
shiftin (spiin)	225
shiftout (spiout)	228
sleep	230
sound	231
srlatch	232
srset / sreset	234
stop	235
suspend	236
swap	237
switch on/off	238
symbol	239
table	240
tablecopy	241
tmr3setup	242
toggle	244
togglebit	245
touch	246
touch16	247
tune	250
uniin	257
uniout	258
wait	260
write	261
writemem	262
writei2c	263
Appendix 1 - Commands	264
Appendix 2 - Additional (non-command) reserved words	265
Appendix 3 - Reserved Labels	266
Appendix 4 - Possible Conflicting Commands	267
Appendix 5 - X2 Variations	268
Appendix 6 - M2 Variations	269
Manufacturer Website:	270
Trademark:	270
Acknowledgements:	270

BASIC COMMANDS

Introduction.

The PICAXE manual is divided into three sections:

- Section 1 - Getting Started
- Section 2 - BASIC Commands
- Section 3 - Microcontroller interfacing circuits

This second section provides the syntax (with detailed examples) for all the BASIC commands supported by the PICAXE system. It is intended as a lookup reference guide for each BASIC command supported by the PICAXE system. As some commands only apply to certain size PICAXE chips, a diagram beside each command indicates the sizes of PICAXE that the command applies to.

When using the flowchart method of programming, only a small subset of the available commands are supported by the on-screen simulation. These commands are indicated by the corresponding flowchart icon by the description.

For more general information about how to use the PICAXE system, please see section 1 'Getting Started'.

PICAXE Software

The main Windows application used for programming the PICAXE chips is called the '**PICAXE Programming Editor**'. This software is free of charge to PICAXE users.

Please see section 1 of the manual ('Getting Started') for installation details and tutorials. Please ensure that you are using the latest version, the software is a free download from www.picaxe.com

AXEpad is a simpler free version of the Programming Editor software for use on the Linux and Mac operating systems. It also supports all the BASIC commands in this manual.

Logicator for PIC micros is a flowcharting application designed for educational use. Programs are developed as graphical flowcharts on screen. These flowcharts are then automatically converted into BASIC files for download into the PICAXE chips.

PICAXE VSM is a Berkeley SPICE circuit simulator, which will simulate complete electronic circuits using PICAXE chips. The BASIC program can be stepped through line by line whilst watching the input/output peripheral react to the program.

The latest version of the software is available on the PICAXE website at

www.picaxe.com

If you have a question about any command please post a question on the very active support forum at this website

www.picaxeforum.co.uk

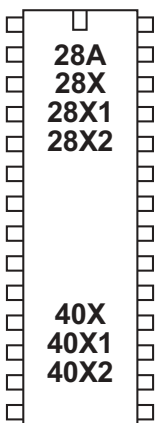
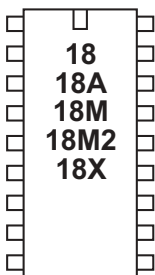
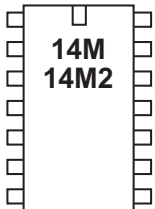
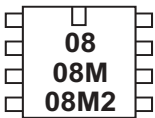

Labels

Labels are used as markers throughout the program. Labels are used to mark a position in the program to 'jump to' from another position using a goto, gosub or other command. Labels can be any word (that is not already a reserved keyword) and may contain digits and the underscore character. Labels must start with a letter or underscore (not digit), and are followed directly by a colon (:) at the marker position. The colon is not required within the actual commands.

The compiler is not case sensitive (lower and/or upper case may be used at any time).

Example:

```
main:
    high B.1      ; switch on output 1
    pause 5000   ; wait 5 seconds
    low B.1      ; switch off output 1
    pause 5000   ; wait 5 seconds
    goto main    ; loop back to start
```

Whitespace

Whitespace is the term used by programmers to define the white area on a printout of the program. This involves spaces, tabs and empty lines. Any of these features can be used to space the program to make it clearer and easier to read.

It is convention to only place labels on the left hand side of the screen. All other commands should be indented by using the 'tab key.' This convention makes the program much easier to read and follow.

Newline

Commands are normally placed on separate lines. However if desired the colon (:) character can be used to separate multiple commands on a single line e.g.

```
if pin1 = 1 then : high 1 : else : low 1 : endif
```

Line continuation

Long lines can be continued onto a second line by using an underscore e.g.

```
if pin1 = 1 then gosub _
    label1 ; continued on second line
```

Code Collapsing

On long programs in Programming Editor the { and } brackets can be used to collapse ("hide") sections of code to make programs clearer e.g.

```
{
    high 1
}
```

Comments

Comments are used to add information into the program for future reference. They are completely ignored by the computer during a download. Comments begin with an apostrophe (') or semicolon (;) and continue until the end of the line. The keyword REM may also be used for a comment.

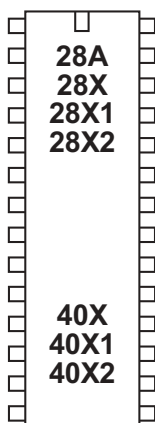
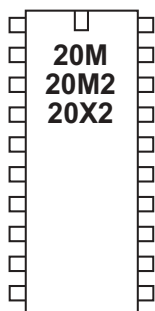
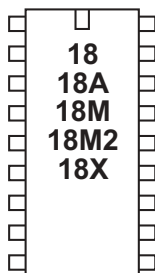
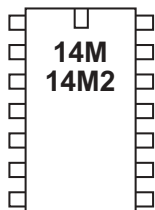
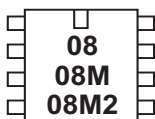

Multiple lines can be commented by use of the #REM and #ENDREM directives.

Examples:

```
high 0           ; make output 0 high
low 0           REM make output 0 low
```

```
#rem           ; #rem out a number of lines
high 0
pause 2000
#endrem
```

Constants

Constants are 'fixed' numbers that are used within the program. The software supports word integers (any whole number between 0 and 65535).

Constants can be declared in four ways: decimal, hex, binary and ASCII.

Decimal	numbers are typed directly without any prefix.
Hexadecimal (hex)	numbers are preceded with a dollar-sign (\$) or (0x).
Binary	numbers are preceded by a percent-sign (%).
ASCII text strings	are enclosed in quotes ("").

Examples:

```
100             ; 100 decimal
$64            ; 64 hex
0x64           ; 64 hex
%01100100     ; 01100100 binary
"A"           ; "A" ascii (65)
"Hello"       ; "Hello" - equivalent to "H","e","l","l","o"
B1 = B0 ^ $AA ; xor variable B0 with AA hex
```

Symbols

Symbols can be assigned to constant values, and can also be used as alias names for variables (see Variables overleaf for more details). Constant values and variable names are assigned by following the symbol name with an equal-sign (=), followed by the variable or constant. Symbols can use any word that is not a reserved keyword (e.g. switch, step, output, input, etc. cannot be used)

Symbols can contain numeric characters and underscores (flash1, flash_2 etc.) but the first character cannot be numeric (e.g. 1flash). Simple constant maths is also available. See the symbol command entry later in this manual for more information. The use of symbols does not increase program length.

Example:

```
symbol RED_LED = B.7 ; define a constant symbol
symbol COUNTER = b0  ; define a variable symbol
let COUNTER = 200    ; preload variable with value 200

mainloop:           ; define a program address

                    ; address symbol end with colons
                    high RED_LED ; switch on output B.7
                    pause COUNTER ; wait 0.2 seconds
                    low RED_LED  ; switch off output B.7
                    pause COUNTER ; wait 0.2 seconds
                    goto mainloop ; loop back to start
```

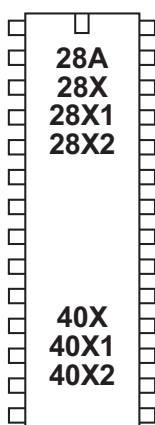
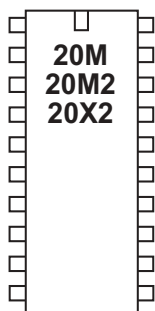
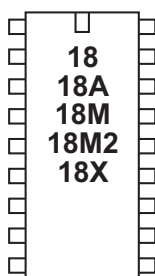
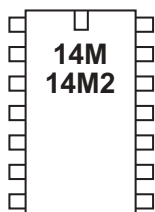
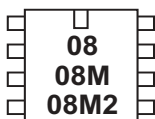

Directives

Directives are used by the software to set the current PICAXE type and to determine which sections of the program listing are to be compiled. Directives are therefore not part of the PICAXE program, they are instructions to the software compiler.

All directives start with a # and must be used on a single line. Any other non-relevant line content after the directive is ignored.

Directives marked *Programming Editor Only* are only supported by the PICAXE Programming Editor software and will not work with third party applications.

#picaxe xxx

Set the compiler mode. This directive also automatically defines a label of the PICAXE type e.g. #picaxe 08m2 is also the equivalent of #define 08m2. If no #picaxe directive is used the system defaults to the currently selected PICAXE mode (View>Options>Mode menu within Programming Editor).

Example: #picaxe 08m2

#com device

Set the serial/USB COM port for downloading.

Examples:

#com 1	(Windows AXE026 serial)
#com 6	(Windows AXE027 USB*)
#com / dev/ ttyS0	(Linux AXE026 serial)
#com / dev/ ttyUSB0	(Linux AXE027 USB*)
#com / dev/ tty.usbserial-xxxx	(Mac AXE027 USB*)
#com 1	(Windows CE AXE027 USB*)
#com / dev/ tty.iap	(iPhone/iPod Touch AXE026 serial)

Note that on Linux systems the COM port device name is actually one less than the COM port, so COM1 is "/dev/ttyS0". On Mac systems xxxx is a unique serial number. Device names are also case sensitive - type exactly as shown.

**See the AXE027 USB cable datasheet for more details.*

#slot number

Select the internal program slot (0-3) or i2c program slot (4-7) on X2 parts.

#revision number

Set the user program version (1-254) on X2 parts.

#no_data

Do not download EEPROM data (only active on parts where program and data are separate).

#no_table

Do not download table or EEPROM data (X1 and X2 parts only). This automatically also enables #no_data

#no_end

Do not automatically add an 'end' command to the end of the program.

#freq m4/m8/m16

Set the default system clock download frequency for 28X/40X parts only.
Not required for any other parts that automatically use their internal resonator.

Example: **#freq m8**

#define label

Defines a label to use in an ifdef or ifndef statements.

Example: **#define clock8**

Do not confuse the use of #define and symbol =

#define is a directive and, when used with #ifdef, determines which sections of code are going to be compiled.

'symbol = ' is a command used within actual programs to re-label variables and pins.

#undefine label

Removes a label from the current defines list

Example: **#undefine clock8**

#ifdef / #ifndef label

#else

#endif

Conditionally compile code depending on whether a label is defined (#ifdef) or not defined (#ifndef).

Example: **#define clock8**
 #ifdef clock8
 let b1 = 8
 #else
 let b1 = 4
 #endif

#error "comment"

Force a compiler error at the current position

Example: **#error "Code not finished!"**

#rem / #endrem

Comment out multiple lines of text.

Example:

```
#rem
high 0
pause 1000
low 0
#endrem
```

#include "filename"

Include code from a separately saved file within this program.

Example: **#include "c:\test.bas"**

NOTE: Reserved for future use. Not currently implemented.

Programming Editor Only Directives

#simtask all/0/1/2/3 *Programming Editor Only*

The task to follow during simulation when using parallel multi-tasking M2 parts.

If no task is specified task 0 will be automatically traced.

Multiple tasks can also be traced at the same time by using 'all'

Examples: **#simtask 1**
 #simtask all

#sim axe101/axe102/axe103/axe105/axe107/axe092 *Programming Editor Only*

Use a 'simulated project kit' on screen whilst simulating

Example: **#sim axe105**

#simspeed value *Programming Editor Only*

Set the simulation delay (in milliseconds) between commands

Example: **#simspeed 200**

#terminal off/300/600/1200/4800/9600/19200/38400 *Programming Editor Only*

Configure the Serial Terminal to open after a download (at selected baud rate)

Example: **#terminal 4800**

#gosubs 16/255 *Programming Editor Only*

Set the gosubs mode (16/255) on older 18X/ 28X parts.

Example: **#gosubs 16**

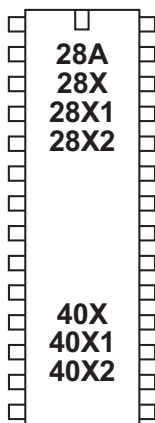
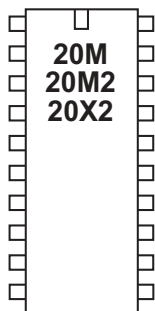
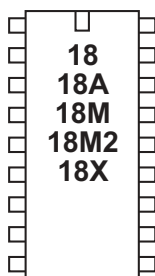
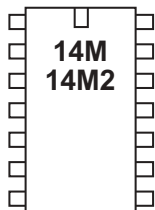
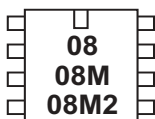

Variables - General

The RAM memory is used to store temporary data in variables as the program runs. It loses all data when the power is removed or reset. There are four types of RAM variables - general purpose, scratchpad, storage, and special function.

See the 'let' command for details about variable mathematics.

General Purpose Variables.

	Bytes	Bit Name	Byte Name	Word Name
X2 parts	56	bit0-31	b0-55	w0-27
X1 parts	28	bit0-31	b0-27	w0-13
M2 parts	28	bit0-31	b0-27	w0-13
Older parts	14	bit0-15	b0-13	w0-6

There are 14 (or more) general purpose byte variables. These byte variables are labelled b0, b1 etc... Byte variables can store integer numbers between 0 and 255 inclusive. Byte variables cannot use negative numbers or fractions, and will 'overflow' without warning if you exceed the 0 or 255 boundary values (e.g. 254 + 3 = 1) (2 - 3 = 255)

However for larger numbers two byte variables can be combined to create a word variable, which is capable of storing integer numbers between 0 and 65535 inclusive. These word variables are labelled w0, w1, w2 etc... and are constructed as follows:

- w0 = b1 : b0
- w1 = b3 : b2
- w2 = b5 : b4
- w3 = b7 : b6
- etc...

Therefore the most significant byte of w0 is b1, and the least significant byte of w0 is b0.

In addition there are up to 32 individual bit variables (bit0, bit1 etc...). These bit variables can be used where you just require a single bit (0 or 1) storage capability. Bit variables are part of the lower value byte variables e.g.

- b0 = bit7: bit6: bit5: bit4: bit3: bit2: bit1: bit0
- b1 = bit15: bit14: bit13: bit12: bit11: bit10: bit9: bit8
- etc...

You can use any word, byte or bit variable within any mathematical assignment or command that supports variables. However take care that you do not accidentally repeatedly use the same 'byte' or 'bit' variable that is being used as part of a 'word' variable elsewhere.

Indirect Addressing of General Purpose Variables (M2/X2 parts)

On these parts there are up to 256 general purpose variables. The lower bytes, known as b0, b1, b2 etc upwards, can be used directly in any command (as with all other PICAXE parts). All 256 bytes (0-255) can also be addressed both directly and indirectly.

To directly address the values the peek (read the byte) and poke (write the byte) commands are used. To indirectly address the values the virtual variable name '@bptr' is used. @bptr is a variable name that can be used in any command (ie as where a 'b1' variable would be used). However the value of the variable is not fixed (as with b1), but will contain the current value of the byte currently 'pointed to' by the byte pointer (bptr).

The compiler also accepts '@bptrinc' (post increment) and '@bptrdec' (post decrement).

Every time the '@bptrinc' variable name is used in a command the value of the byte pointer is automatically incremented by one (ie bptr = bptr+1 occurs automatically after the read/write of the value @bptr). This makes it ideal for storage of a single dimensional array of data.

Variables - Storage

Storage variables are additional memory locations allocated for temporary storage of byte data. They cannot be used in mathematical calculations, but can be used to temporarily store byte values by use of the peek and poke commands.

The number of available storage locations varies depending on PICAXE type. The following table gives the number of available byte variables with their addresses. These addresses vary according to technical specifications of the microcontroller. See the poke and peek command descriptions for more information.

08M2	99	28 to 127 (\$1C to \$7F)
18M2	227	28 to 255 (\$1C to \$FF)
18M2+, 14M2, 20M2	483	28 to 511 (\$1C to \$1FF)
28X2, 40X2	200	56 to 255 (\$38 to \$FF)
20X2	72	56 to 127 (\$38 to \$7F)
All X1 parts	95	80 to 126 (\$50 to \$7E), 192 to 239 (\$C0 to \$EF)

All X1 and X2 parts also have the additional scratchpad memory, see next page.

Older discontinued parts:

All M parts	48	80 to 127 (\$50 to \$7F)
All A parts	48	80 to 127 (\$50 to \$7F)
18X	96	80 to 127 (\$50 to \$7F), 192 to 239 (\$C0 to \$EF)
28X, 40X	112	80 to 127 (\$50 to \$7F), 192 to 255 (\$C0 to \$FF)
08	none	

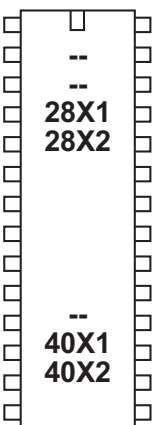
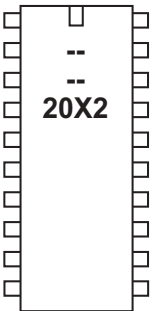
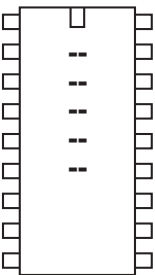
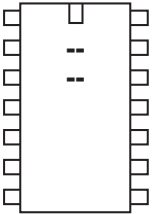
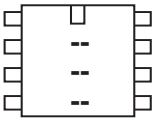

Variables - Scratchpad

The scratchpad is a temporary memory area for storage of data such as arrays.

PICAXE-28X1, 40X1, 20X2 parts have 128 scratchpad bytes (0-127)

PICAXE-28X2, 40X2 parts have 1024 scratchpad bytes (0-1023)

To directly address the scratchpad values the get (read the byte) and put (write the byte) commands are used.

To indirectly address the values the virtual variable name '@ptr' is used. @ptr is a variable name that can be used in any command (ie as where a 'b1' variable would be used). However the value of the variable is not fixed (as with b1), but will contain the current value of the byte currently 'pointed to' by the pointer (ptr).

The compiler also accepts '@ptrinc' (post increment) and '@ptrdec' (post decrement). Every time the '@ptrinc' variable name is used in a command the value of the scratchpad pointer is automatically incremented by one (ie ptr = ptr+1 occurs automatically after the read/write of the value @ptr). This makes it ideal for storage of a single dimensional array of data.

```
ptr = 1           ' reset scratchpad pointer to 1
serrxd @ptrinc,@ptrinc,@ptrinc,@ptrinc,@ptrinc
                ' serin 5 bytes to scratchpad addresses 1-5
```

```
ptr = 1           ' reset scratchpad pointer to 1
for b1 = 1 to 5
  sertxd (@ptrinc) ' re-transmit those 5 values
next b1
```

See the put and get commands for more details.

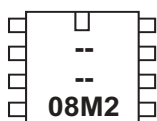

Variables - System

The M2 parts have 8 word variables which are reserved for system hardware use. However if that piece of system hardware is not used within a program the variables may be used as general purpose variables.

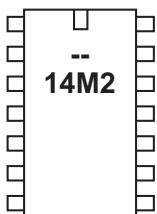

s_w0	task	current task (during parallel processing)
s_w1	-	<i>reserved for future use</i>
s_w2	-	<i>reserved for future use</i>
s_w3	-	<i>reserved for future use</i>
s_w4	-	<i>reserved for future use</i>
s_w5	-	<i>reserved for future use</i>
s_w6	-	<i>reserved for future use</i>
s_w7	time	elapsed time

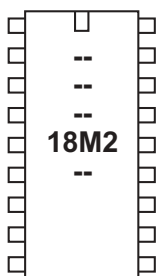

The X1 and X2 parts have 8 word variables and 1 flags byte which are reserved for system hardware use. However if that piece of system hardware is not used within a program the variables may be used as general purpose variables.

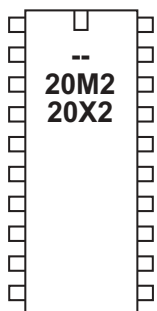

s_w0	-	<i>reserved for future use</i>
s_w1	-	<i>reserved for future use</i>
s_w2	adcstep2	high word of adcsetup (28X2 only)
s_w3	timer3	timer3 value (X2 only)
s_w4	compvalue	comparator results (X2 only)
s_w5	hserptr	hardware serin pointer
s_w6	hi2clast	hardware hi2c last byte written (slave mode)
s_w7	timer	timer value

The 'flags' byte variable is made up of 8 bit variables

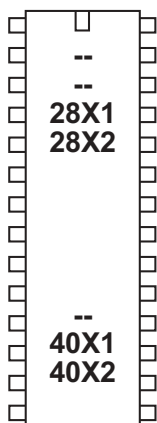

flag0	hint0flag	X2 only - interrupt on B.0
flag1	hint1flag	X2 only - interrupt on B.1
flag2	hint2flag	X2 only - interrupt on B.2
flag3	hintflag	X2 only - interrupt on any of above
flag4	compflag	X2 only - occurs on any comparator change
flag5	hserflag	hserial background receive has occurred
flag6	hi2cflag	hi2c write has occurred (slave mode)
flag7	toflag	timer overflow flag

Variables - Special function

The special function variables available for use depend on the PICAXE type:

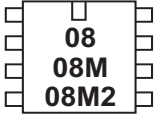

PICAXE-08 / 08M / 08M2 Special Function Registers

pins = the input / output port
 dirs = the data direction register (sets whether pins are inputs or outputs)
 infra = another term for variable b13, used within the 08M infrain2 command

Additional 08M2 Special Function Registers

bptr - the byte RAM pointer
 @bptr - the byte RAM value pointed to by bptr
 @bptrinc - the byte RAM value pointed to by bptr (post increment)
 @bptrdec - the byte RAM value pointed to by bptr (post decrement)
 time - the current time (seconds counter at 4MHz or 16MHz)
 task - the current task

The variable pins is broken down into individual bit variables for reading from individual inputs with an if...then command. Only valid input pins are implemented.

pins = x : x : x : pin4 : pin3 : pin2 : pin1 : x

The variable dirs is also broken down into individual bits. Only valid bi-directional pin configuration bits are implemented.

dirs = x : x : x : dir4 : x : dir2 : dir1 : x

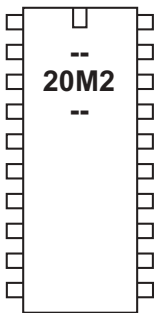
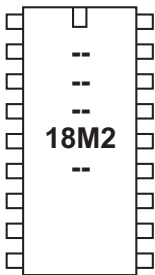
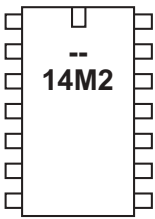

PICAXE-14M2 / 18M2 / 20M2 Special Function Registers

pinsB	- the portB input pins
outpinsB	- the portB output pins
dirsB	- the portB data direction register
pinsC	- the portC input pins
outpinsC	- the portC output pins
dirsC	- the portC data direction register
bptr	- the byte RAM pointer
@bptr	- the byte RAM value pointed to by bptr
@bptrinc	- the byte RAM value pointed to by bptr (post increment)
@bptrdec	- the byte RAM value pointed to by bptr (post decrement)
time	- the current time (seconds counter at 4MHz or 16MHz)
task	- the current task

When used on the left of an assignment 'pins' applies to the 'output' pins e.g.

```
let outpinsB = %11000000
```

will switch outputs 7,6 high and the others low.

When used on the right of an assignment 'pins' applies to the input pins e.g.

```
let b1 = pinsB
```

will load b1 with the current state of the input pin on portB.

The variable pinsX is broken down into individual bit variables for reading from individual inputs with an if...then command. Only valid input pins are implemented e.g.

```
pinsB = pinB.7 : pinB.6 : pinB.5 : pinB.4 :  
pinB.3 : pinB.2 : pinB.1 : pinB.0
```

The variable outpinX is broken down into individual bit variables for writing outputs directly. Only valid output pins are implemented. e.g.

```
outpinsB = outpinB.7 : outpinB.6 : outpinB.5 : outpinB.4 :  
outpinB.3 : outpinB.2 : outpinB.1 : outpinB.0
```

The variable dirsX is broken down into individual bit variables for setting inputs/ outputs directly e.g.

```
dirsB = dirB.7 : dirB.6 : dirB.5 : dirB.4 :  
dirB.3 : dirB.2 : dirB.1 : dirB.0
```

See the 'Variables - General' section for more information about

@bptr, @bptrinc, @bptrdec

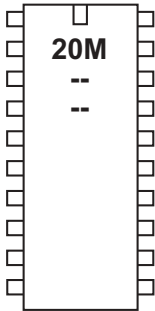
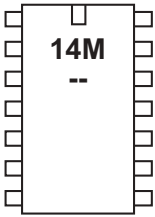

PICAXE-14M/20M Special Function Registers (NOT 14M2 / 20M2)

pins = the input port when reading from the port
 (out)pins = the output port when writing to the port
 infra = a separate variable used within the infrain command
 keyvalue = another name for infra, used within the keyin command

Note that pins is a 'pseudo' variable that can apply to both the input and output port.

When used on the left of an assignment pins applies to the 'output' port e.g.

```
let pins = %11000000
```

will switch outputs 7,6 high and the others low.

When used on the right of an assignment pins applies to the input port e.g.

```
let b1 = pins
```

will load b1 with the current state of the input port.

Additionally, note that

```
let pins = pins
```

means 'let the output port equal the input port'

To avoid this confusion it is recommended that the name 'outpins' is used in this type of statement e.g.

```
let outpins = pins
```

The variable pins is broken down into individual bit variables for reading from individual inputs with an if...then command. Only valid input pins are implemented.

14M pins = x : x : x : pin4 : pin3 : pin2 : pin1 : pin0

20M pins = pin7 to pin0

The variable outpins is broken down into individual bit variables for writing outputs directly. Only valid output pins are implemented.

14M outpins = x : x : outpin5 : outpin4 : outpinx : outpin2 : outpin1 : outpin0

20M outpins = outpin7 to outpin0

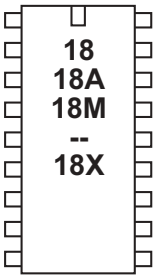

PICAXE-18 / 18A / 18M / 18X Special Function Registers (NOT 18M2)

pins = the input port when reading from the port
 (out)pins = the output port when writing to the port
 infra = a variable used within the infrain command (=B13 on 18M)
 keyvalue = another name for infra, used within the keyin command

Note that pins is a 'pseudo' variable that can apply to both the input and output port.

When used on the left of an assignment pins applies to the 'output' port e.g.

```
let pins = %11000000
```

will switch outputs 7,6 high and the others low.

When used on the right of an assignment pins applies to the input port e.g.

```
let b1 = pins
```

will load b1 with the current state of the input port.

Additionally, note that

```
let pins = pins
```

means 'let the output port equal the input port'

To avoid this confusion it is recommended that the name 'outpins' is used in this type of statement e.g.

```
let outpins = pins
```

The variable pins is broken down into individual bit variables for reading from individual inputs with an if...then command. Only valid input pins are implemented.

```
pins = pin7 : pin6 : x : x : x : pin2 : pin1 : pin0
```

The variable outpins is broken down into individual bit variables for writing outputs directly. Only valid output pins are implemented.

```
outpins = outpin7 : outpin6 : outpin5 : outpin4 :  
outpin3 : outpin2 : outpin1 : outpin0
```

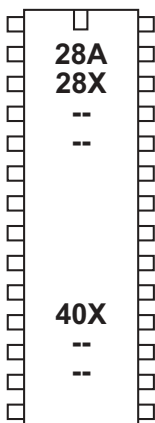

PICAXE-28A / 28X / 40X Special Function Registers

pins = the input port when reading from the port
 (out)pins = the output port when writing to the port
 infra = a separate variable used within the infrain command
 keyvalue = another name for infra, used within the keyin command

Note that pins is a 'pseudo' variable that can apply to both the input and output port.

When used on the left of an assignment pins applies to the 'output' port e.g.

```
let pins = %11000000
```

will switch outputs 7,6 high and the others low.

When used on the right of an assignment pins applies to the input port e.g.

```
let b1 = pins
```

will load b1 with the current state of the input port.

Additionally, note that

```
let pins = pins
```

means 'let the output port equal the input port'

To avoid this confusion it is recommended that the name 'outpins' is used in this type of statement e.g.

```
let outpins = pins
```

The variable pins is broken down into individual bit variables for reading from individual inputs with an if...then command. Only valid input pins are implemented.

```
pins = pin7 : pin6 : pin5 : pin4 : pin3 : pin2 : pin1 : pin0
```

The variable outpins is broken down into individual bit variables for writing outputs directly. Only valid output pins are implemented.

```
outpins = outpin7 : outpin6 : outpin5 : outpin4 :  
outpin3 : outpin2 : outpin1 : outpin0
```

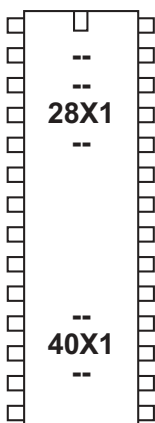

PICAXE-28X1 / 40X1 Special Function Registers

pins = the input port when reading from the port
outpins = the output port when writing to the port
ptr = the scratchpad pointer
@ptr = the scratchpad value pointed to by ptr
@ptrinc = the scratchpad value pointed to by ptr (post increment)
@ptrdec = the scratchpad value pointed to by ptr (post decrement)
flags = system flags

When used on the left of an assignment 'outpins' applies to the 'output' port e.g.

```
let outpins = %11000000
```

will switch outputs 7,6 high and the others low.

When used on the right of an assignment 'pins' applies to the input port e.g.

```
let b1 = pins
```

will load b1 with the current state of the input port.

The variable pins is broken down into individual bit variables for reading from individual inputs with an if...then command. Only valid input pins are implemented.

```
pins = pin7 : pin6 : pin5 : pin4 : pin3 : pin2 : pin1 : pin0
```

The variable outpins is broken down into individual bit variables for writing outputs directly. Only valid output pins are implemented.

```
outpins = outpin7 : outpin6 : outpin5 : outpin4 :  
outpin3 : outpin2 : outpin1 : outpin0
```

The scratchpad pointer variable is broken down into individual bit variables:

```
ptr = ptr7 : ptr6 : ptr5 : ptr4 : ptr3 : ptr2 : ptr1 : ptr0
```

See the 'Variables - Scratchpad' section for more information about

```
@ptr, @ptrinc, @ptrdec
```

The system 'flags' byte is broken down into individual bit variables. If the special hardware feature of the flag is not used in a program the individual flag may be freely used as a user defined bit flag.

Name	Special	Special function
flag0	-	reserved for future use
flag1	-	reserved for future use
flag2	-	reserved for future use
flag3	-	reserved for future use
flag4	-	reserved for future use
flag5	hserflag	hserial background receive has occurred
flag6	hi2cflag	hi2c write has occurred (slave mode)
flag7	toflag	timer overflow flag

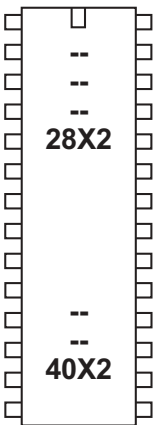
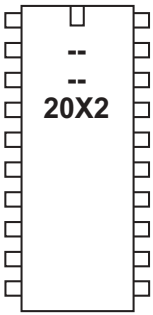

PICAXE-20X2 / 28X2 / 40X2 Special Function Registers

pinsA	-the portA input pins
dirsA	- the portA data direction register
pinsB	- the portB input pins
dirsB	- the portB data direction register
pinsC	- the portC input pins
dirsC	- the portC data direction register
pinsD	- the portD input pins
dirsD	- the portD data direction register
bptr	- the byte RAM pointer
@bptr	- the byte RAM value pointed to by bptr
@bptrinc	- the byte RAM value pointed to by bptr (post increment)
@bptrdec	- the byte RAM value pointed to by bptr (post decrement)
ptr	- the scratchpad pointer (ptrh : ptrl)
@ptr	- the scratchpad value pointed to by ptr
@ptrinc	- the scratchpad value pointed to by ptr (post increment)
@ptrdec	- the scratchpad value pointed to by ptr (post decrement)
flags	- system flags

When used on the left of an assignment 'pins' applies to the 'output' pins e.g.

```
let pinsB = %11000000
```

will switch outputs 7,6 high and the others low.

When used on the right of an assignment 'pins' applies to the input pins e.g.

```
let b1 = pinsB
```

will load b1 with the current state of the input pin on portB.

The variable pinsX is broken down into individual bit variables for reading from individual inputs with an if...then command. Only valid input pins are implemented e.g.

```
pinsB = pinB.7 : pinB.6 : pinB.5 : pinB.4 :
        pinB.3 : pinB.2 : pinB.1 : pinB.0
```

The variable outpinX is broken down into individual bit variables for writing outputs directly. Only valid output pins are implemented. e.g.

```
outpinsB = outpinB.7 : outpinB.6 : outpinB.5 : outpinB.4 :
           outpinB.3 : outpinB.2 : outpinB.1 : outpinB.0
```

The variable dirsX is broken down into individual bit variables for setting inputs/ outputs directly e.g.

```
dirsB = dirB.7 : dirB.6 : dirB.5 : dirB.4 :
        dirB.3 : dirB.2 : dirB.1 : dirB.0
```

The byte scratchpad pointer variable is broken down into individual bit variables:

```
bptrl = bptr7 : bptr6 : bptr5 : bptr4 : bptr3 : bptr2 : bptr1 : bptr0
```

See the 'Variables - General' section for more information about

```
@bptr, @bptrinc, @bptrdec
```

The scratchpad pointer variable is broken down into individual bit variables:

```
ptrl = ptr7 : ptr6 : ptr5 : ptr4 : ptr3 : ptr2 : ptr1 : ptr0
ptrh = xxxx : xxxx : xxxx : xxxx : xxxx : xxxx : ptr9 : ptr8
```

See the 'Variables - Scratchpad' section for more information about
@ptr, @ptrinc, @ptrdec

The system 'flags' byte is broken down into individual bit variables. If the special hardware feature of the flag is not used in a program the individual flag may be freely used as a user defined bit flag.

Name	Special	Special function
flag0	hint0flag	hardware interrupt on pin INT0
flag1	hint1flag	hardware interrupt on pin INT1
flag2	hint2flag	hardware interrupt on pin INT2
flag3	hintflag	hardware interrupt on any pin 0,1,2
flag4	compflag	hardware interrupt on comparator
flag5	hserflag	hserial background receive has occurred
flag6	hi2cflag	hi2c write has occurred (slave mode)
flag7	toflag	timer overflow flag

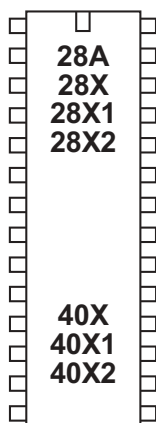
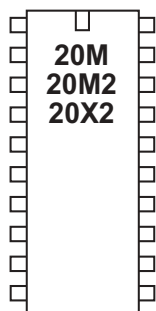
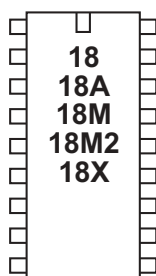
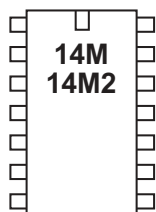
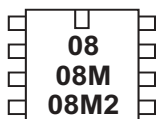

Variables - Mathematics

The PICAXE microcontrollers support word (16 bit) mathematics. Valid integers are 0 to 65535. All internal mathematics is 16 bit, however when, for instance, the output target is a byte (8 bit) variable (0-255), if the result of the internal calculation is greater than 255 overflow will occur without warning.

Maths is performed strictly from left to right. Unlike some computers and calculators, the PICAXE does not give * and / priority over + and -.

Therefore $3+4 \times 5$ is calculated as

$$3+4=7$$

$$7 \times 5=35$$

The microcontroller does not support fractions or negative numbers. However it is sometimes possible to rewrite equations to use integers instead of fractions, e.g.

let w1 = w2 / 5.7

is not valid, but

let w1 = w2 * 10 / 57

is mathematically equal and valid.

The mathematical functions supported by all parts are:

+		; add	
-		; subtract	
*		; multiply	(returns low word of result)
**		; multiply	(returns high word of result)
/		; divide	(returns quotient)
//	%	; modulus divide	(returns remainder)
MAX		; limit value to a maximum value	
MIN		; limit value to a minimum value	
AND	&	; bitwise AND	
OR		; bitwise OR	(typed as SHIFT + \ on UK keyboard)
XOR	^	; bitwise XOR	(typed as SHIFT + 6 on UK keyboard)
NAND		; bitwise NAND	
NOR		; bitwise NOR	
XNOR	^/	; bitwise XNOR	
ANDNOT	&/	; bitwise AND NOT	(NB this is <i>not</i> the same as NAND)
ORNOT	/	; bitwise OR NOT	(NB this is <i>not</i> the same as NOR)

The X1 and X2 parts also support

<<		; shift left	
>>		; shift right	
*/		; multiply	(returns middle word of result)
DIG		; return the digit value	
REV		; reverse a number of bits	

All mathematics is performed strictly from left to right.

On X1 and X2 parts it is possible to enclose part equations in brackets e.g.

```
let w1 = w2 / (b5 + 2)
```

On all other chips it is not possible to enclose part equations in brackets e.g.

```
let w1 = w2 / (b5 + 2)
```

is not valid. This would need to be entered in equivalent form e.g.

```
let w1 = b5 + 2
```

```
let w1 = w2 / w1
```

Further Information:

Addition and Subtraction

The addition (+) and subtraction (-) commands work as expected. Note that the variables will overflow without warning if the maximum or minimum value is exceeded (0-255 for bytes variables, 0-65535 for word variables).

Multiplication and Division

When multiplying two 16 bit word numbers the result is a 32 bit (double word) number. The multiplication (*) command returns the low word of a word*word calculation. The ** command returns the high word of the calculation and */ returns the middle word.

Therefore in normal maths \$aabb x \$ccdd = \$eeffgghh

In PICAXE maths

```
$aabb * $ccdd = $gghh
```

```
$aabb ** $ccdd = $eeff
```

The X1 and X2 parts also support return of the middle word

```
$aabb */ $ccdd = $ffgg
```

The division (/) command returns the quotient (whole number) word of a word*word division. The modulus (// or %) command returns the remainder of the calculation.

Max and Min

The MAX command is a limiting factor, which ensures that a value never exceeds a preset value. In this example the value never exceeds 50. When the result of the multiplication exceeds 50 the max command limits the value to 50.

```
let b1 = b2 * 10 MAX 50
```

```
if b2 = 3 then b1 = 30
```

```
if b2 = 4 then b1 = 40
```

```
if b2 = 5 then b1 = 50
```

```
if b2 = 6 then b1 = 50 ' limited to 50
```

The MIN command is a similar limiting factor, which ensures that a value is never less than a preset value. In this example the value is never less than 50. When the result of the division is less than 50 the min command limits the value to 50.

```
let b1 = 100 / b2 MIN 50
```

```
if b2 = 1 then b1 = 100
```

```
if b2 = 2 then b1 = 50
```

```
if b2 = 3 then b1 = 50 ' limited to 50
```

AND, OR, XOR, NAND, NOR, XNOR, ANDNOT, ORNOT

The AND, OR, XOR, NAND, NOR, XNOR commands function bitwise on each bit in the variables. ANDNOT and ORNOT mean, for example 'A AND the NOT of B' etc. This is not the same as NOT (A AND B), as with the traditional NAND command.

A common use of the AND (&) command is to mask individual bits:

```
let b1 = pins & %00000110
```

This masks inputs 1 and 2, so the variable only contains the data of these two inputs.

<<, >>

Shift left (or shift right) have the same effect as multiplying (or dividing) by 2. All bits in the word are shifted left (or right) a number of times. The bit that 'falls off' the left (or right) side of the word is lost.

```
let b1 = %00000110 << 2
```

DIG

The DIG (digit) command returns the decimal value of a specified digit (0-4, right to left) of a 16 bit number. Therefore digit 0 of '67890' is 0 and digit 3 is '7'. To return the ASCII value of the digit simply add string "0" to the digit value e.g.

```
let b1 = b2 DIG 0 + "0"
```

See also the BINTOASCII and BCDTOASCII commands.

REV

The REV (reverse) command reverses the order of the specified number of bits of a 16 bit number. Therefore to reverse the 8 bits of %10110000 (to %00001101) the command would be

```
let b1 = %10110000 REV 8
```

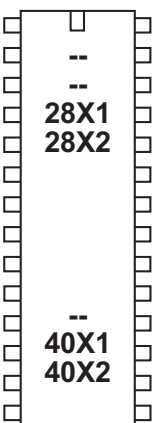
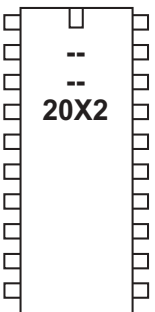
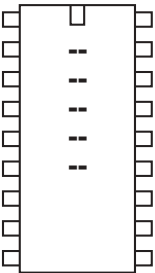
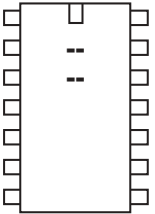
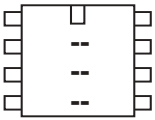
Variables - Unary Mathematics

All parts support the NOT unary command e.g.

let b1 = NOT pins

All parts support the unary minus command e.g.

let b1 = -b1

The X1 and X2 parts also support these unary commands

SIN	; sine of angle (0 to 65535) in degrees
COS	; cosine of angle in degrees
SQR	; square root
INV	; invert / complement
NCD	; encoder (2n power encoder)
DCD	; decoder (2n power decoder)
BINTOBCD	; convert binary value to BCD
BCDTOBIN	; convert BCD value to binary
NOB	; count number of set bits (X2 only)
ATAN	; calculate the arctan of a value (result 0-45 degrees) (X2 only)

Unary commands must be the first command on a program line. However they may be followed by additional mathematical commands eg.

let b1 = sin 30 + 5 is valid

let b1 = 5 + sin 30 is not valid as the unary command is not first

Further Information:

NOT

The NOT function inverts a value.

e.g let b1 = NOT %01110000 (answer b1 = %10001111)

SIN and COS

The sin function returns a number equivalent to the sine of the value in degrees. The system uses a 45 step lookup table in each quadrant, giving a very fast, and reasonably accurate, result.

The sine function only works on positive whole integers. However as all sin and cos values repeat every 360 degrees, simply add 360 to make a negative value positive. e.g. sin (-30) is the same as sin (330) (-30 + 360)

As the real sine value is always a value between 1 and -1, a coding system is used to increase the accuracy when working with PICAXE whole integers. The value returned by the sin function is actually 100 x the real sine value. Therefore in normal mathematics $\sin 30 = 0.5$. In PICAXE mathematics this is returned as 50 ($100 * 0.5$). This coding method provides a sine function accuracy equivalent to two decimal places.

e.g let b1 = sin 30 (answer b1 = 50)

Negative numbers are indicated by setting bit 7 of the returned byte. This has the effect of making negative values appear as 128 + the expected value.

e.g let b1 = sin 210 (answer b1 = 128+50 = 178)

The cos function operates in an identical manner.

SQR

The square root function returns the whole integer square root, according to 10 iterations of a N-R formula, using a seed of value/2. This formula provides a fast and accurate result. Note that as the PICAXE chip only operates with whole integers, the result will be rounded down to the nearest whole value.

e.g `let b1 = sqr 64` (answer b1 = 8)

INV (~)

The invert function complements each bit in the value (ie each 0 is changed to a 1 and each 1 is changed to 0).

e.g `let b1 = ~ %10101010` (answer b1 = %01010101)

NCD

The encoder function takes a value and finds the position of the highest bit in that number that is a 1. Therefore the result will be a number 1 to 16, when bit15 is 1 the answer is 16, when only bit0 is 1 the value is 1. If the value is 0, the result will be 0.

e.g `let b1 = ncd %00000100` (answer b1 = 3)

DCD

The decoder function takes a value between 0 and 15 and returns a 16 bit number, with that value bit set to 1.

e.g `let b1 = dcd 3` (answer b1 = %00001000)
`let w1 = dcd 8` (answer w1 = %100000000)

BINTOBCD

The bintobcd function converts a value to binary coded decimal. Note that the maximum value that can be returned within a byte is 99, or 9999 within a word.

e.g `let b1 = bintobcd 99` (answer b1 = %10011001=\$99)

BCDTOBIN

The bcdtobin function converts a binary coded decimal value to normal binary.

e.g `let b1 = bcdtobin $99` (answer b1 = 99)

NOB (X2 only)

The nob function counts the number of bits that are set.

e.g `let b1 = NOB %10100111` (answer b1 = 5)

ATAN (X2 only)

The atan function provides an arctan function for angles between 0 and 45 degrees. This is useful, for example, for calculating robot direction paths.

As the arctan input is always a value between 0 and 1, a coding system is used to increase the accuracy when working with PICAXE whole integers. The value used by the atan function is actually 100 x the real atan value (e.g. 0.39 = 39)

e.g `let b1 = atan 100` (answer b1 = 45)

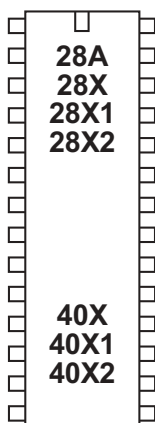
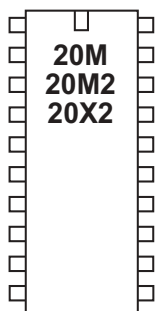
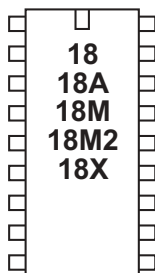
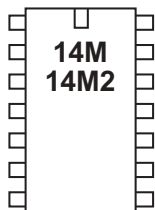
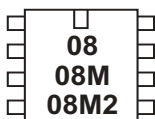

Input / Output Pin Naming Conventions

The first PICAXE chips had a maximum of 8 input and 8 output pins, so there was no need for a port naming scheme, as there was only one default input port and one default output port for each chip.

Therefore input and outputs pins were just referred to by their pin number

e.g.	<i>Output commands</i>	<i>Input Commands</i>
	high 1	count 2, 100, w1
	sound 2, (50,50)	pulsin 1, 1, w1
	serout 3, N2400, (b1)	serin 0, N2400, b3

However on later M2 and X2 PICAXE parts more flexibility was added by allowing almost all of the pins to be configured as inputs or outputs as desired. This creates more than 8 inputs or outputs and an amended naming scheme is therefore required. Therefore the pins on these parts are referred to by the new PORT.PIN notation. Up to 4 ports (A, B, C, D) are available, depending on chip pin count.

e.g.	<i>Output commands</i>	<i>Input Commands</i>
	high B.1	count A.2, 100, w1
	sound C.2, (50,50)	pulsin B.1, 1, w1
	serout A.3, N2400, (b1)	serin C.0, N2400, b3

In the case of if...then statements which check the status of the input pin variable, the naming convention of these input pin variables have changed in a similar style from

```

if pin1 =1 then...
to
if pinC.1 = 1 then...

```

The name of the input pins byte for each port is changed from

```

pins
to
pinsA, pinsB, pinsC, pinsD

```

The name of the output pins byte for each port is changed from

```

outpins
to
outpinsA, outpinsB, outpinsC, outpinsD

```

The name of the data direction register for each port is changed from

```

dirs
to
dirsA, dirsB, dirsC, dirsD

```

This manual generally uses the newer PORT.PIN format in the examples unless an example is specifically for an older part.

Please see the pinout diagrams (in part 1 of the PICAXE manual) for the chip you are using. Note that input / output pin numbers used within commands are not the same as the physical leg numbers!

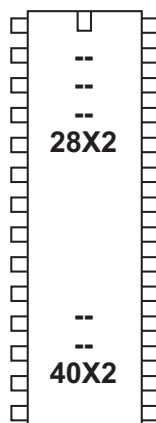
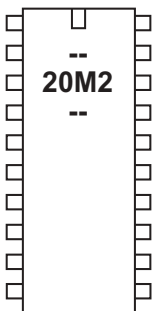
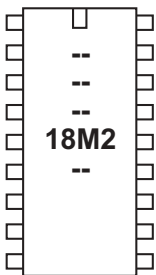
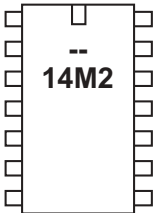
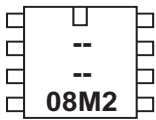

Firmware>=B.3

adconfig

Syntax:

adconfig config

- config is a constant/variable specifying the adc configuration

Function:

Configure the ADC reference voltages

Information:

The default Vref+ signal for the ADC is the power supply (V+) and the default Vref- signal is 0V, so the analogue voltage range is the same as the power supply to the PICAXE chip. However, if desired, the Vref signals can be altered to external pins instead by using adconfig command.

PICAXE X2 PARTS

- Bit 3,2 = 11 *do not use*
- = 10 VRef+ is FVR (see FVRsetup command)
- = 01 VRef+ is external pin
- = 00 VRef+ is V+ (power supply)
- Bit 1,0 = 11 *do not use*
- = 10 *do not use*
- = 01 VRef- is external pin
- = 00 VRef- is 0V

PICAXE M2 PARTS

- Bit 2 = 1 VRef- is external pin (if available)
- = 0 VRef- is 0V
- Bit 1,0 = 11 VRef+ is FVR (see FVRsetup command)
- = 10 VRef+ is external pin (if available)
- = 01 *do not use*
- = 00 VRef+ is V+ (power supply)

PICAXE	External Vref+ pin	External Vref- Pin
08M2	C.1	n/a
14M2	B.1	n/a
18M2	n/a	C.2
20M2	B.0	n/a
28X2	A.3	A.2
40X2	A.3	A.2

Example (18M2):

```
fvrsetup FVR2048 ; set FVR as 2.048V
adconfig %011 ; set FVR as ADC Vref+, 0V Vref-
```

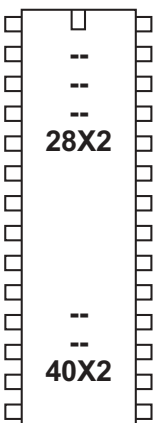
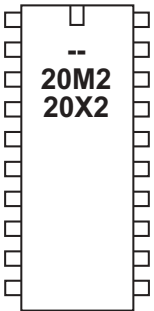
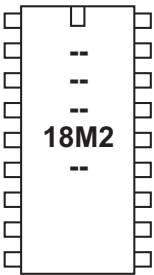
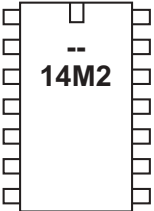
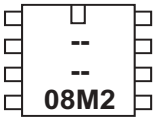

adcsetup

Syntax:

{let} adcsetup = channels

- Channels is the number / mask of ADC to enable.

Function:

On X2 parts it is necessary to configure the ADC pins for use with the 'readadc/readadc10' commands. On all other parts this configuration is automatic.

On M2 parts the appropriate adcsetup bit is set automatically by the 'readadc/readadc10/touch' command. Therefore on these parts the only real use of adcsetup is to change a pin back from analogue to digital setup.

Note that adcsetup is technically a variable (word length), not a command, and so can be used in 'let' assignments and mathematics (e.g bit masking using &).

Using adcsetup does NOT actually 'connect' the internal adc to the input pin - the adc is always connected! Using adcsetup just disconnects the digital input buffer, so that the internal digital input circuitry does not effect the analogue reading. Therefore readadc commands may still work without correctly configuring adcsetup, however the analogue readings may not be as reliable as expected.

Due to advances in microcontroller technology the use of 'adcsetup' varies slightly according to the part in use. Please ensure you study the correct page for the part you are using. There are separate pages for:

PICAXE-28X2	(PIC18F25K22)
PICAXE-40X2	(PIC18F45K22)
PICAXE-28X2-5V	(PIC18F2520)
PICAXE-40X2-5V	(PIC18F4520)
PICAXE-28X2-3V	(PIC18F25K20)
PICAXE-40X2-3V	(PIC18F45K20)
PICAXE-20X2	(PIC18F14K22)
Any M2 part	(08M2, 14M2, 18M2, 20M2)

PICAXE-28X2 (PIC18F25K22) (not older -5V or -3V versions)

PICAXE-40X2 (PIC18F45K22) (not older -5V or -3V versions)

Individual Pin Masking

With individual pin masking any pin can be individually controlled. Setting the bit disconnects the corresponding digital input to dedicate to analogue operation.

Note that with these parts the appropriate bit is always automatically set upon any readadc / readadc10 / touch / touch16 command. Therefore the only real use of this command is to turn an analogue pin back into a digital pin by clearing the appropriate bit.

adcsetup variable

Bit 0 - ADC0	Bit 8 - ADC8
Bit 1 - ADC1	Bit 9 - ADC9
Bit 2 - ADC2	Bit 10 - ADC10
Bit 3 - ADC3	Bit 11 - ADC11
Bit 4 - ADC4	Bit 12 - ADC12
Bit 5 - ADC5	Bit 13 - ADC13
Bit 6 - ADC6	Bit 14 - ADC14
Bit 7 - ADC7	Bit 15 - not used

adcsetup2 variable

Bit 0 - ADC16	Bit 8 - ADC24
Bit 1 - ADC17	Bit 9 - ADC25
Bit 2 - ADC18	Bit 10 - ADC26
Bit 3 - ADC19	Bit 11 - ADC27
Bit 4 - ADC20	Bit 12 - not used
Bit 5 - ADC21	Bit 13 - not used
Bit 6 - ADC22	Bit 14 - not used
Bit 7 - ADC23	Bit 15 - not used

Voltage Reference

The default Vref+signal is the power supply (V+) and Vref- signal is 0V, so the analogue voltage range is the same as the power supply to the PICAXE chip. However, if desired, the Vref signals can be altered to external pins instead by using the adconfig command.

Example:

```
let adcsetup = %000000000001111 ; set ADC0,1,2,3
```

PICAXE-28X2 -5V (PIC18F2520)

PICAXE-40X2 -5V (PIC18F4520)

Sequential Masking

With sequential masking pins can only be configured for analogue readings if:

- the internal pin of the microcontroller supports analogue (see pinout)
- the pin is already configured as an input
- all ADC with a lower number are also enabled

With the sequential system, for instance, it is only possible to enable ADC3 if ADC0-2 are also enabled. This is an internal design restraint of the PICmicro, not the PICAXE bootstrap. The number of channels and active ADC pins are shown below.

channels	28X2-5V	40X2-5V
0	none	none
1	ADC0	ADC0
2	ADC0,1	ADC0,1
3	ADC0,1,2	ADC0,1,2
4	ADC0,1,2,3	ADC0,1,2,3
5	ADC0,1,2,3,8	ADC0,1,2,3,5
6	ADC0,1,2,3,8,9	ADC0,1,2,3,5,6
7	ADC0,1,2,3,8,9,10	ADC0,1,2,3,5,6,7
8	ADC0,1,2,3,8,9,10,11	ADC0,1,2,3,5,6,7,8
9	ADC0,1,2,3,8,9,10,11,12	ADC0,1,2,3,5,6,7,8,9
10	-	ADC0,1,2,3,5,6,7,8,9,10
11	-	ADC0,1,2,3,5,6,7,8,9,10,11
12	-	ADC0,1,2,3,5,6,7,8,9,10,11,12

ADC4,5,6,7 do not exist on the 28X2-5V parts.

ADC4 does not exist on the 40X2-5V parts.

Voltage Reference

The default Vref+signal is the power supply (V+) and Vref- signal is 0V, so the analogue voltage range is the same as the power supply to the PICAXE chip. However, if desired, the Vref signals can be altered to external pins instead by setting bits 15 and 14 of adcsetup.

Bit 15	= 1	VRef- is ADC2
	= 0	VRef- is 0V
Bit 14	= 1	VRef+ is ADC3
	= 0	VRef+ is V+ (power supply)

Example:

```
let adcsetup = 4 ; set ADC0,1,2,3 as analogue
```

PICAXE-20X2 (PIC18F14K22)

PICAXE-28X2-3V (PIC18F25K20)

PICAXE-40X2-3V (PIC18F45K20)

Individual Pin Masking

With individual pin masking any pin can be individually controlled. Setting the bit disconnects the corresponding digital input to dedicate to analogue operation.

Bit 0 - ADC0	Bit 8 - ADC8
Bit 1 - ADC1	Bit 9 - ADC9
Bit 2 - ADC2	Bit 10 - ADC10
Bit 3 - ADC3	Bit 11 - ADC11
Bit 4 - ADC4	Bit 12 - ADC12
Bit 5 - ADC5	Bit 13 - <i>not used</i>
Bit 6 - ADC6	Bit 14 - VRef+
Bit 7 - ADC7	Bit 15 - VRef- (<i>not available on 20X2</i>)

Voltage Reference

The default Vref+ signal is the power supply (V+) and Vref- signal is 0V, so the analogue voltage range is the same as the power supply to the PICAXE chip. However, if desired, the Vref signals can be altered to external pins instead by setting bits 15 and 14 of adcsetup.

Bit 15	= 1	VRef- is ADC2 (28X2, 40X2) (<i>not available on 20X2</i>)
	= 0	VRef- is 0V
Bit 14	= 1	VRef+ ADC3 (28X2, 40X2) or ADC1 (20X2)
	= 0	VRef+ is V+ (power supply)

Example:

```
let adcsetup = %0000000000001111 ; set ADC0,1,2,3
```

ALL M2 series parts

Individual Pin Masking

With individual pin masking any pin can be individually controlled. Setting the bit disconnects the corresponding digital input to dedicate to analogue operation.

Note that with M2 parts the appropriate bit is always automatically set upon any readadc / readadc10 / touch command. Therefore the only real practical use of this command is to turn an analogue pin back into a digital pin by clearing the appropriate bit.

08M2

Bit 1 - ADC on C.1
 Bit 2 - ADC on C.2
 Bit 4 - ADC on C.4

14M2, 18M2, 20M2

Bit 0 - ADC on B.0	Bit 8 - ADC on C.0
Bit 1 - ADC on B.1	Bit 9 - ADC on C.1
Bit 2 - ADC on B.2	Bit 10 - ADC on C.2
Bit 3 - ADC on B.3	Bit 11 - ADC on C.3
Bit 4 - ADC on B.4	Bit 12 - ADC on C.4
Bit 5 - ADC on B.5	Bit 13 - ADC on C.5
Bit 6 - ADC on B.6	Bit 14 - ADC on C.6
Bit 7 - ADC on B.7	Bit 15 - ADC on C.7

Voltage Reference

The default Vref+ signal is the power supply (V+) and Vref- signal is 0V, so the analogue voltage range is the same as the power supply to the PICAXE chip. However, if desired, the Vref signals can be altered to external pins instead by use of the 'adconfig' command.

Example:

```
let adcsetup = %00001111 ; set ADC on B.0-B.3
```

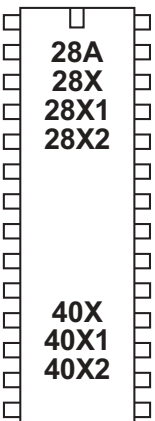
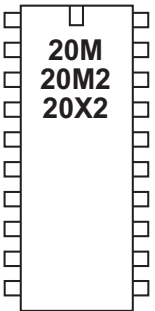
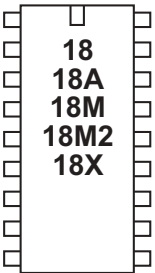
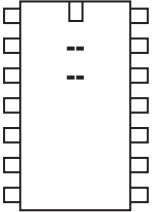
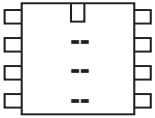

backward

Syntax:

BACKWARD motor

- Motor is the motor name A or B.

Function:

Make a motor output turn backwards

Information:

This is a 'pseudo' command designed for use by younger students with pre-assembled classroom models. It is actually equivalent to 'low 4 : high 5' (motor A) or 'low 6 : high 7' (motor B). This command is not normally used outside of the classroom.

Example:

```
main: forward A           ; motor a on forwards
      wait 5              ; wait 5 seconds
      backward A         ; motor a on backwards
      wait 5              ; wait 5 seconds
      halt A             ; motor A stop
      wait 5              ; wait 5 seconds
      goto main          ; loop back to start
```

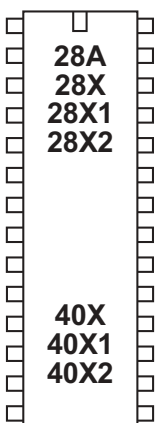
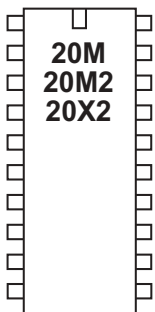
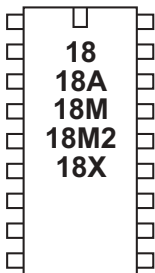
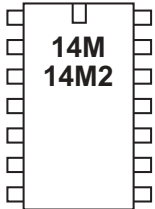
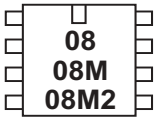

bcdtoascii

Syntax:

BCDTOASCII variable, tens, units

BCDTOASCII wordvariable, thousands, hundreds, tens, units

- Variable contains the value (0-99) or wordvariable (0-9999)
- Thousands receives the ASCII value ("0" to "9")
- Hundreds receives the ASCII value ("0" to "9")
- Tens receives the ASCII value ("0" to "9")
- Units receives the ASCII value ("0" to "9")

Function:

Convert a BCD value into separate ASCII bytes.

Information:

This is a 'pseudo' command designed to simplify the conversion of byte or word BCD values into ASCII. Note that the maximum valid value for a BCD value is 99 (byte) or 9999 (word).

Example:

```
main: inc b1
      bcdtoascii b1,b2,b3    ; convert to ascii
      debug                 ; debug values for testing
      goto main            ; loop back to start
```

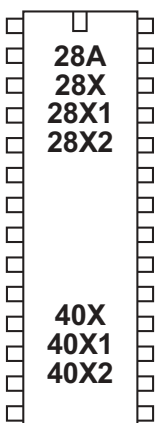
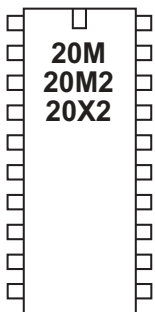
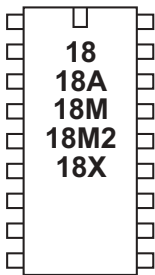
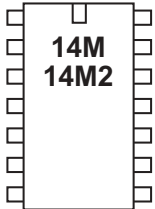
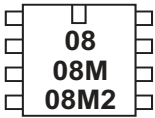

bintoascii

Syntax:

BINTOASCII variable, hundreds, tens, units

BINTOASCII wordvariable, tenthousands, thousands, hundreds, tens, units

- Variable contains the value (0-255) or wordvariable (0-65535)
- TenThousands receives the ASCII value ("0" to "9")
- Thousands receives the ASCII value ("0" to "9")
- Hundreds receives the ASCII value ("0" to "9")
- Tens receives the ASCII value ("0" to "9")
- Units receives the ASCII value ("0" to "9")

Function:

Convert a binary value into separate ASCII bytes.

Information:

This is a 'pseudo' command designed to simplify the conversion of byte or word binary values into ASCII.

Example:

```
main: inc b1
      bintoascii b1,b2,b3,b4 ; convert b1 to ascii
      debug                ; debug values for testing
      goto main            ; loop back to start
```

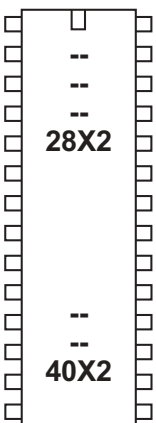
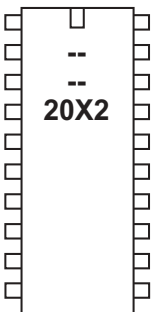
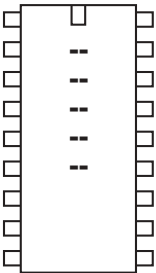
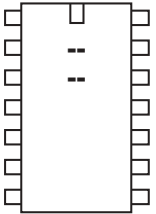
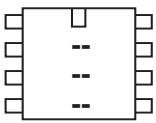

booti2c

Syntax:

booti2c slot

- slot is the external EEPROM address and slot number (4 to 7)

Function:

On X2 parts it is possible to update the internal program by copying a new program from an external i2c EEPROM.

Information:

The booti2c command can be used to copy a program from an external 24LC128 memory slot into an internal memory slot. The booti2c command is only processed if the program revision number (set by the #revision directive during download) in the 24LC128 memory slot is greater than the revision number currently in the internal program slot. This means that the program copying will only occur once after a new 24LC128 is fitted.

If an EEPROM is not correctly connected, the data returned from the circuit will typically be 0 or 255, therefore these two values are not valid #revision numbers and are ignored.

The booti2c command parameter takes the format of a single data byte, which is the external i2c address and slot number.

Bit7	24LC128 A2
Bit6	24LC128 A1
Bit5	24LC128 A0
Bit4	reserved for future use
Bit3	reserved for future use
Bit2	must be set to 1 for i2c use
Bit1, 0	slot number

The lower 2 bits of the slot number (bits 1,0) is copied into the same position within the internal program memory. The data memory is left unchanged. The i2c to internal program copying of slots is therefore mapped as follows (when using an EEPROM with address 0):

i2c slot		internal memory slot
4 (%00000100)	->	0 (%00000000)
5 (%00000101)	->	1 (%00000001)
6 (%00000110)	->	2 (%00000010)
7 (%00000111)	->	3 (%00000011)

After a program has been copied the chip automatically resets (so the program in slot 0 starts running).

Therefore if you wish to program an EEPROM with a program that is eventually targeted for updating internal program slot 2 on a different chip, a '#slot 6' directive should be included upon the computer download into the EEPROM. The EEPROM can then be transferred across and connected to the target system.

The type of EEPROM chip must be a device that has a minimum of a 64 byte page buffer. Therefore the EEPROM recommended is a Microchip brand 24LC128 (or 24LC256 or 24LC512). Non-Microchip brands may not operate correctly if they have different timing specifications or page buffer capacity.

Example:

```
booti2c 1 ; check EEPROM & update slot 1 if required
```

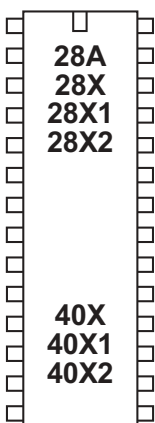
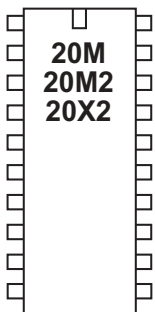
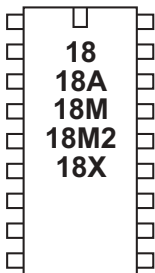
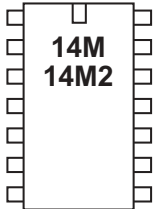
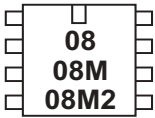

branch

Syntax:

BRANCH offset,(address0,address1...addressN)

- Offset is a variable/constant which specifies which Address# to use (0-N).

- Addresses are labels which specify where to go.

Function:

Branch to address specified by offset (if in range).

Information:

This command allows a jump to different program positions depending on the value of the variable 'offset'. If offset is value 0, the program flow will jump to address0, if offset is value 1 program flow will jump to address1 etc.

If offset is larger than the number of addresses the whole command is ignored and the program continues at the next line.

This command is identical in operation to on...goto

Example:

```

reset1:let b1 = 0
           low B.0
           low B.1
           low B.2
           low B.3

main:  inc b1
           if b1 > 4 then reset1
           branch b1,(btn0,btn1, btn2, btn3, btn4)

btn0:  high B.0
           goto main
btn1:  high B.1
           goto main
btn2:  high B.2
           goto main
btn3:  high B.3
           goto main
btn4:  high B.4
           goto main

```

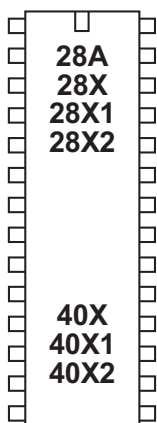
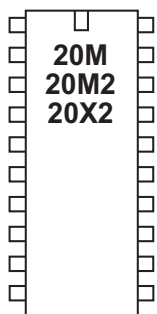
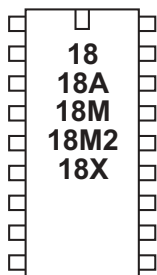
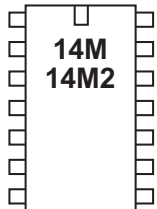
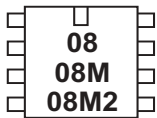

button

Syntax:

BUTTON pin,downstate,delay,rate,bytevariable,targetstate,address

- Pin is a variable/constant which specifies the i/o pin to use.
- Downstate is a variable/constant (0 or 1) which specifies which logical state is read when the button is pressed. If the input is active high, at V+ when the button is pressed (e.g. a 10k pull down resistor with switch wired to V+) then enter 1 here. If the input is active low, at 0V when the button is pressed (e.g. a 10k pull up resistor with switch wired to 0V) then enter 0.
- Delay is a variable/constant (1-254, 0 or 255) which is a counter which specifies the number of loops to complete before the auto repeat feature starts if BUTTON is used within a loop. If the value is between 1 and 254 this value will be loaded into the bytevariable when the switch becomes active, and then decremented on every loop whilst the button is still active. Only when the counter reaches 0 will the address be processed for the second time. This gives an initial delay before the auto-repeat starts. A value of 255 disables the auto-repeat feature. The button will still be debounced, so use the value 255 when you want a simple debounce feature without auto repeat. A value of 0 disables both the debounce and auto-repeat features. Therefore with delay=0 the command will operate as a simple 'if pin = targetstate then' command.
- Rate is a variable/constant (0-255) which specifies the auto-repeat rate in BUTTON cycles. After the initial delay this value will be loaded into the bytevariable, and then decremented on every loop whilst the button is still active. Only when the value reaches 0 will the address be processed again. This gives the delay between every auto-repeat cycle.
- Bytevariable is a variable which is used as the workspace for the auto repeat loop counters. It must be cleared to 0 before being used by BUTTON for the first time (before the loop that BUTTON is used within.)
- Targetstate is a variable/constant (0 or 1) which specifies what state (0=not pressed, 1=pressed) the button should be in for the branch (goto) to address to occur. This value can be used to 'invert' the operation of the address jump, jumping when either pushed (1) or when not pushed (0).
- Address is a label which specifies where to go if the button is in the target state.

Function:

Debounce button, auto-repeat, and branch if button is in target state.

Information:

When mechanical switches are activated the metal 'contacts' do not actually close in one smooth action, but 'bounce' against each other a number of times before settling. This can cause microcontrollers to register multiple 'hits' with a single physical action, as the microcontroller can register each bounce as a new hit. One simple way of overcoming this is to simply put a small pause (e.g. pause 10) within the program, this gives time for the switch to settle.

Alternately the button command can be used to overcome these issues. When the button command is executed, the microcontroller looks to see if the 'downstate' is matched. If this is true the switch is debounced, and then program flow jumps to 'address' if 'targetstate' = 1. If targetstate = '0' the program continues.

If the button command is within a loop, the next time the command is executed 'downstate' is once again checked. If the condition is still true, the variable 'bytevariable' is loaded with the 'delay' value. On each subsequent loop where the condition is still true bytevariable is decremented until it reaches 0. At this point a second jump to 'address' is made if 'targetstate' = 1. Bytevariable is then reset to the 'rate' value and the whole process then repeats, as once again on each loop bytevariable is decremented until it reaches 0, and at 0 another jump to 'address' is made if 'targetstate' = 1.

This gives action like a computer keyboard key press - send one press, wait for 'delay' number of loops, then send multiple presses at time interval 'rate'. Note that button should be used within a loop. It does not pause program flow and so only checks the input switch condition as program flow passes through the command.

Example:

```

init:    b2 = 0                                ; reset targetbyte
                                                ; before the loop

; input C.0, active high, jump to 'pushed' label when = 1

myloop:  button C.0,1,200,100,b2,1,pushed
                                                ; jump to cont when C.0 = 1
        low B.7                                ; output off
        pause 10                               ; loop delay time
        goto myloop

pushed:  high B.7                              ; output on
        sertextd ("PUSH")                      ; send push message
        goto myloop

```

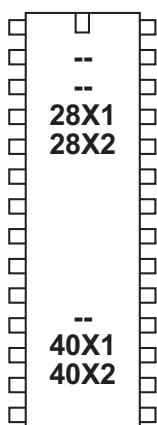
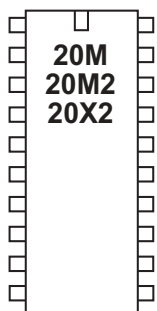
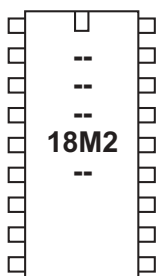
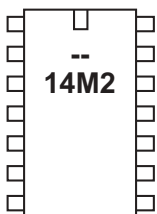
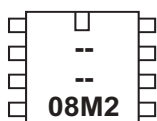

calibadc (calibadc10)

Syntax:

CALIBADC variable

CALIBADC10 wordvariable

- variable receives the adc reading

Function:

Calibrate the microcontrollers internal ADC by measuring a fixed internal fixed voltage reference.

0.6V 20M, 28X1, 40X1

1.2V 28X2-3V, 28X2-3V

1.024V All other parts that support this command

Note that this command is not available on 28X2-5V/40X2-5V

Information:

The reference voltage used by the PICAXE microcontrollers ADC reading (readadc/ readadc10) commands is the supply voltage. In the case of a battery powered system, this supply voltage can change over time (as the battery runs down), resulting in a varying ADC reading for the same voltage input.

The calibadc/calibadc10 commands can help overcome this issue by providing the ADC reading of a nominal internal reference. Therefore by periodically using the calibadc command you can mathematically calibrate/compensate the readadc command for changes in supply voltage.

calibadc can be considered as 'carry out a readadc on a fixed reference'

Note that the voltage specified is a nominal voltage only and will vary with each part. Microchip datasheet AN1072 provides further details on how to software calibrate and use this advanced feature.

A formula to use the 0.6V value is

$$V_{\text{supply}} = \text{step} * 6 / \text{calib} / 10$$

where step = 255 (calib) or 1023 (calibadc10) and calib is the value returned from the calibadc command. Note that *6 / 10 is mathematically equivalent to multiply by 0.6 (the voltage reference).

Example:

main:

```

calibadc b1           ; read the adc reading
debug                ; display current value
pause 500            ; wait a while
goto main            ; loop back to start

```

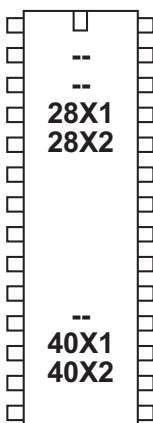
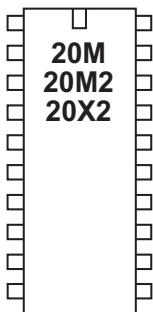
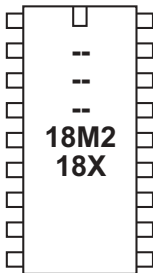
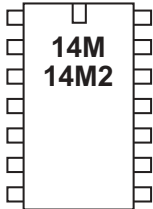
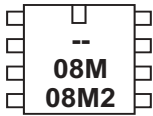

calibfreq

Syntax:

CALIBFREQ{-} factor

- factor is a constant/variable containing the value -15 to 15

Function:

Calibrate the microcontrollers internal resonator. 0 is the default factory setting.

Information:

PICAXE chips have an internal resonator that can be set to different operating speeds via the setfreq command.

On these chips it is also possible to 'calibrate' this frequency. This is an advanced feature not normally required by most users, as all chips are factory calibrated to the most accurate setting. Generally the only use for calibfreq is to slightly adjust the frequency for serial transactions with third party devices. A larger positive value increases speed, a larger negative value decreases speed. Try the values -4 to +4 first, before going to a higher or lower value.

Use this command with extreme care. It can alter the frequency of the PICAXE chip beyond the serial download tolerance - in this case you will need to perform a 'hard-reset' in order to carry out a new download.

The calibfreq is actually a pseudo command that performs a 'poke' command on the microcontrollers OSCTUNE register.

When the value is 0 to 15 the equivalent BASIC code is

```
pokesfr OSCTUNE, factor
pause 2
```

When the factor is -15 to -1 the equivalent BASIC code is

```
let b12 = 64 - factor
pokesfr OSCTUNE, b12
pause 2
```

Note that in this case variable b12 is used, and hence corrupted, by the command. This is necessary to poke the OSCTUNE register with the correct value.

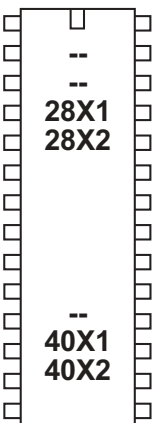
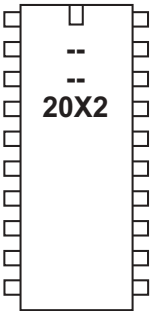
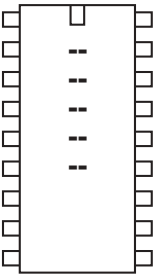
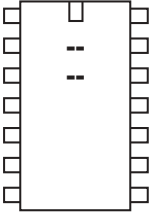
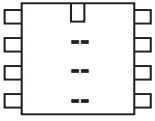

clearbit

Syntax:

CLEARBIT var, bit

- var is the target variable.
- bit is the target bit (0-7 for byte variables, 0-15 for word variables)

Function:

Clear a specific bit in the variable.

Information:

This command clears (clears to 0) a specific bit in the target variable.

Example:

```
clearbit b6, 0
clearbit w4, 15
```

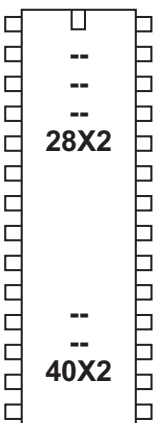
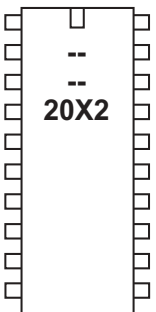
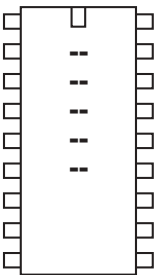
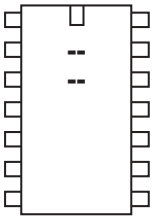
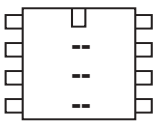

compsetup

Syntax:

COMPSETUP config, ivr

- config is a constant/variable specifying the comparator configuration
- ivr is a constant/variable specifying the internal voltage reference 'resistor-ladder' configuration

Function:

Configure the internal comparators on X2 parts.

Information:

PICAXE-X2 chips have 2 comparators, each with the capability of comparing two analogue voltages from two external ADC pins or from an external ADC pin and an internally generated voltage reference. External ADC must be configured using the adcsetup variable before using this command.

PICAXE-28X2-5V (PIC18F2520) and 40X2-5V (PIC18F4520)

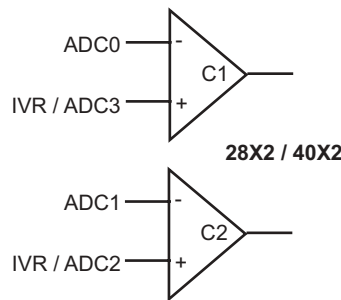

Config:

- bit7 *not used, use 0*
- bit6 = 0 Comparator 1 Vin+ is ADC3 and Comparator 2 Vin+ is ADC2
- = 1 Comparator of both Vin+ is from voltage divider
- bit5 *not used, use 0*
- bit4 = 0 Change in either comparator does not cause change in compflag
- = 1 Change in either comparator sets compflag
- bit3 = 0 Comparator 2 output is not inverted
- = 1 Comparator 2 output is inverted
- bit2 = 0 Comparator 1 output is not inverted
- = 1 Comparator 1 output is inverted
- bit1 = 0 Comparator 2 is disabled
- = 1 Both Comparator 1 & 2 are enabled
- bit0 = 0 Comparator 1 is disabled
- = 1 Comparator 1 is enabled

PICAXE-28X2 (PIC18F25K22) / 40X2 (PIC18F45K22)**PICAXE-28X2-3V (PIC18F25K20) / 40X2-3V (PIC18F45K20)**

Config:

- bit9 = 0 Comparator 2 Vin+ is set from voltage divider
 = 1 Comparator 2 Vin+ is from fixed 1.2V reference
- bit8 = 0 Comparator 1 Vin+ is set from voltage divider
 = 1 Comparator 1 Vin+ is from fixed 1.2V reference
- bit7 = 0 Comparator 2 Vin+ is ADC2
 = 1 Comparator 2 Vin+ is from voltage divider/fixed ref
- bit6 = 0 Comparator 1 Vin+ is ADC3
 = 1 Comparator 1 Vin+ is from voltage divider/fixed ref
- bit5 = 0 Change in comparator 2 does not cause change in compflag
 = 1 Change in comparator 2 sets compflag
- bit4 = 0 Change in comparator 1 does not cause change in compflag
 = 1 Change in comparator 1 sets compflag
- bit3 = 0 Comparator 2 output is not inverted
 = 1 Comparator 2 output is inverted
- bit2 = 0 Comparator 1 output is not inverted
 = 1 Comparator 1 output is inverted
- bit1 = 0 Comparator 2 is disabled
 = 1 Comparator 2 is enabled
- bit0 = 0 Comparator 1 is disabled
 = 1 Comparator 1 is enabled

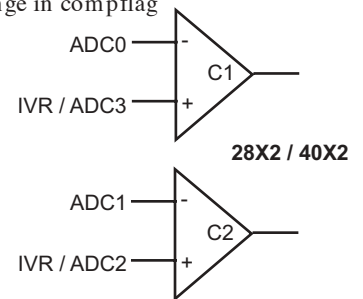

PICAXE-20X2

Config:

bit9	= 0	Comparator 2 Vin+ is set from voltage divider
	= 1	Comparator 2 Vin+ is from fixed 1.024V reference
bit8	= 0	Comparator 1 Vin+ is set from voltage divider
	= 1	Comparator 1 Vin+ is from fixed 1.024V reference
bit7	= 0	Comparator 2 Vin+ is ADC2
	= 1	Comparator 2 Vin+ is from voltage divider/fixed ref
bit6		<i>not used, use 1</i>
bit5	= 0	Change in comparator 2 does not cause change in compflag
	= 1	Change in comparator 2 sets compflag
bit4	= 0	Change in comparator 1 does not cause change in compflag
	= 1	Change in comparator 1 sets compflag
bit3	= 0	Comparator 2 output is not inverted
	= 1	Comparator 2 output is inverted
bit2	= 0	Comparator 1 output is not inverted
	= 1	Comparator 1 output is inverted
bit1	= 0	Comparator 2 is disabled
	= 1	Comparator 2 is enabled
bit0	= 0	Comparator 1 is disabled
	= 1	Comparator 1 is enabled

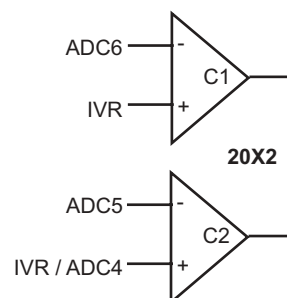

Comparator Result

The result of the two comparators can be read at any time by reading the 'compvalue' variable - bits 0 and 1 of compvalue contain the comparator output. Bit 0 is the output of comparator 1. This output can be inverted, equivalent to reversing the comparator inputs, by setting bit 2 of config. Bit 1 is the output of comparator 2. This output can be inverted, equivalent to reversing the comparator inputs, by setting bit 3 of config.

If required a change in value can be used to trigger a change in the 'compflag' bit. When flag change is enabled (via bits 4 and 5 of config) the 'compflag' will be set whenever there is a change in input condition. This can be used to trigger a 'setintflags' interrupt if required. A change will also trigger a wake from sleep.

Internal Voltage Reference

Each comparator can be compared to a configurable internal voltage reference, generated from an internal resistor ladder (select via bits 6 and 7 of config). On some parts it is also possible to compare to a fixed internal voltage instead of the resistor ladder (select via bits 6, 7, 8 and 9 of config).

The voltage reference is generated from an internal resistor ladder between the power rails as shown in the diagrams overleaf. Note that the actual value of the resistors is not relevant, as they are simply dividers in a potential divider arrangement. The resistors marked 8R are 8 x the value of the other resistors.

The ivr byte used within the compsetup command is configured as follows:

20X2, 28X2, 40X2

bit7 = 0 Voltage Ladder is disabled
 = 1 Voltage Ladder is enabled
 bit6 *not used, use 0*
 bit5 *not used, use 0*
 bit4:0 Select 1 of the 32 voltage tap-off positions

28X2-5V, 28X2-3V, 40X2-5V, 40X2-3V

bit7 = 0 Voltage Ladder is disabled
 = 1 Voltage Ladder is enabled
 bit6 *not used, use 0*
 bit5 = 0 Bottom '8R' resistor is used
 = 1 Bottom '8R' resistor is shorted out and hence not used
 bit4 *not used, use 0*
 bit3:0 Select 1 of the 16 voltage tap-off positions

Example:

```
init:
    adcsetup = 4           ; use adc 0-3 (28X2-5V)
    compsetup %0000011,0 ; use comparators 1 and 2
main:
    b1 = compvalue       ; read value
    debug                ; display value
    pause 500            ; short delay
    goto main            ; loop back
```

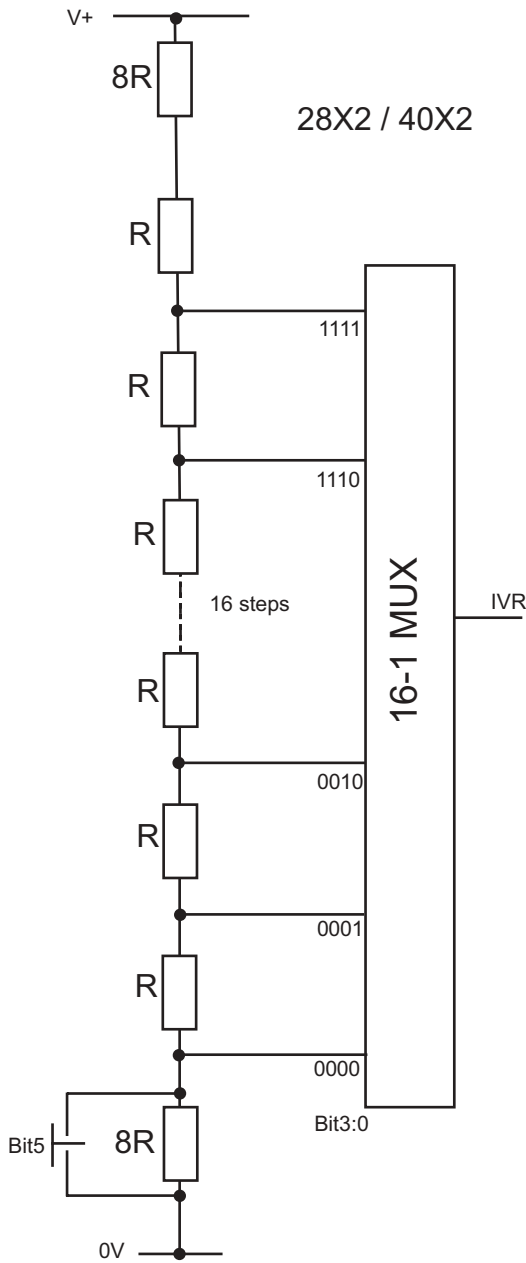
When Bit5 = 1 (bottom resistor shorted)

$$IVR = (\text{position} / 24) * \text{Supply}$$

When Bit5 = 0 (bottom resistor active)

$$IVR = (\text{position}/32) * \text{Supply} + (\text{Supply}/4)$$

Where position = 0 to 15 (Bit3:Bit0)

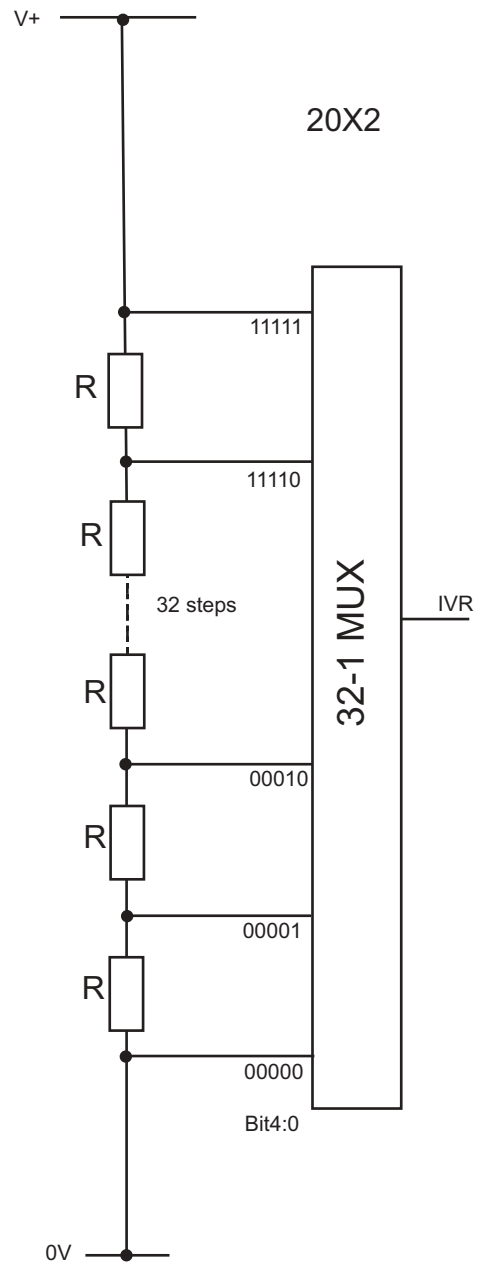

$$IVR = (\text{position} / 32) * \text{Supply}$$

Where position = 0 to 31 (Bit4:Bit0)

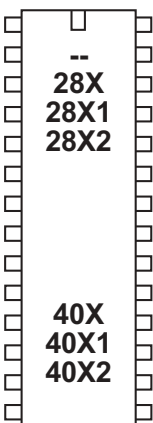
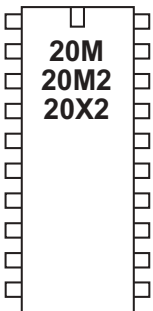
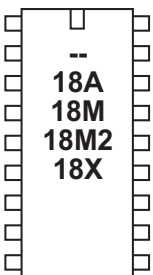
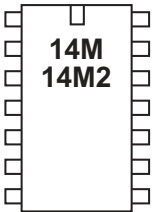
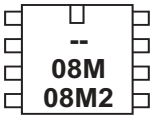

count

Syntax:

COUNT pin, period, wordvariable

- Pin is a variable/constant which specifies the input pin to use.
- Period is a variable/constant (1-65535ms at 4MHz).
- Wordvariable receives the result (0-65535).

Function:

Count pulses on an input pin.

Information:

Count checks the state of the input pin and counts the number of low to high transitions within the time 'period'. A word variable should be used for 'variable'. At 4MHz the input pin is checked every 20us, so the highest frequency of pulses that can be counted is 25kHz, presuming a 50% duty cycle (ie equal on-off time).

Take care with mechanical switches, which may cause multiple 'hits' for each switch push as the metal contacts 'bounce' upon closure.

Effect of increased clock speed:

For all PICAXE chips the minimum width of a clocking signal (total time of high and low added together) and that signal's maximum frequency will be as follows:

<i>Clock Frequency</i>	<i>Signal Width</i>	<i>Signal Frequency</i>
4MHz	40us	25kHz
8MHz	20us	50kHz
16MHz	10us	100kHz
32MHz	5us	200kHz
64MHz	2.5us	400kHz

The unit of time for the sampling period is also affected by the operating speed.

<i>Clock Frequency</i>	<i>Sample Period Time Unit</i>
4MHz	1ms (1000 us)
8MHz	500 us
16MHz	250 us
32MHz	125 us
64MHz	62.5 us

Example:

main:

```

count C.1, 5000, w1 ; count pulses in 5secs (at 4MHz)
debug ; display value
goto main ; loop back to start
    
```

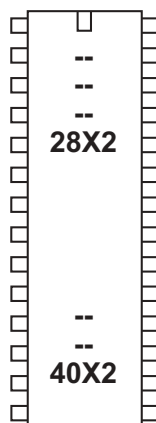
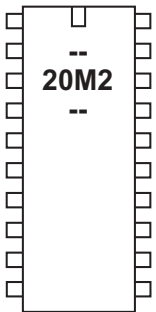
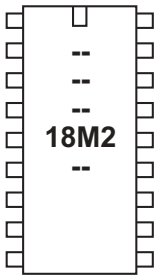
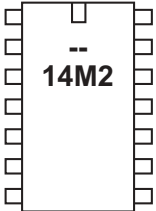
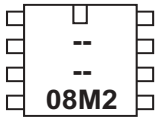

Firmware>=B.3

daclevel

Syntax:

DACLLEVEL level

- Level is a variable/constant which specifies the DAC output level (0-31).

Function:

Set the DAC output level (32 steps, valid value 0-31).

Information:

The daclevel command is used to set the DAC output level to one of 32 levels which cover the entire voltage range of the DAC. Therefore each level is 1/32nd of the maximum voltage. A 'readdac' command can also read the DAC value, this is equivalent to a 'readadc' command on the DAC level.

A dacsetup command must have been used to setup the DAC before this command will function.

Example:

```
init: dacsetup %10100000      ; external DAC, supply voltage
main: for b1 = 0 to 31
      daclevel b1            ; set DAClevel
      pause 1000
next b1
goto main                    ; loop back to start
```

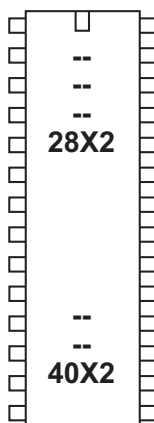
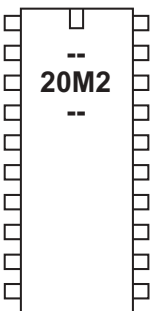
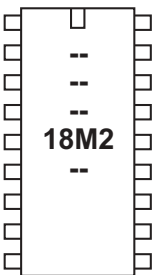
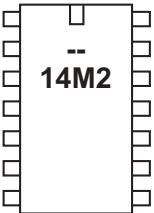
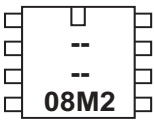

Firmware>=B.3

dacsetup

Syntax:

DACSETUP config

- config is a constant/variable specifying the DAC configuration

Function:

Configure the DAC (digital to analogue) reference voltage

Information:

Some PICAXE chips have a DAC voltage reference. This may be used internally, or externally via the DAC output pin.

Note that the DAC MUST BE BUFFERED for reliable use. It cannot, for instance, provide enough current to light an LED. It is purely a reference voltage for use with, for example, an op-amp configured as a voltage follower.

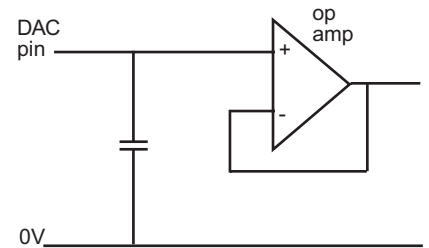

After the DAC has been configured, a 'daclevel' command is used to set the actual DAC level, which is divided by 32 equal steps. The maximum theoretical output value is 31/32 * supply voltage, which equates to 4.84V with a 5V supply.

The best results at 5V supply have been achieved experimentally with a Microchip MCP6022 op amp with a 100nF capacitor, which gave excellent results (4.78V). An OP90GPZ gave the second best result with only slight clipping (4.09V). Older op amps such as the CA3140EZ gave very poor (badly clipped) results (2.73V).

A 'readdac' command can also read the DAC value, this is equivalent to a 'readadc command on the DAC level'. The supply for the DAC can be configured as follows:

Config:

- bit7 = 0 DAC disabled
- = 1 DAC enabled
- bit6 = 0 *not used, use 0*
- bit5 = 0 DAC internal only
- = 1 DAC also on DAC external output pin (overrides input/output)
- bit4 = 0 *not used, use 0*
- bit3-2 = 00 DAC upper is Supply Voltage
- = 01 External Vref+ pin (see adconfig command)
- = 10 FVR voltage (see fvrsetup command)
- = 11 *not used*
- bit1 = 0 *not used, use 0*
- bit0 = 0 DAC lower is Supply 0V
- = 1 External Vref- pin (see adconfig command)

Example:

```
init: low DAC_PIN           ; make the DAC pin an output
      dacsetup %10100000    ; external DAC, supply voltage
main: for b1 = 0 to 31
      daclevel b1          ; set DAClevel
      pause 1000
next b1
goto main                   ; loop back to start
```

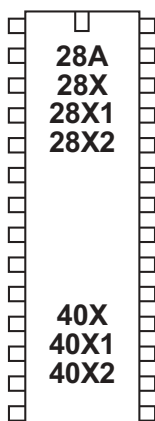
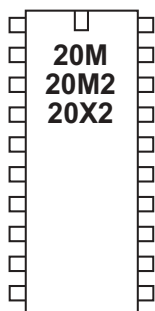
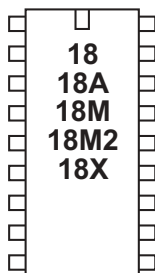
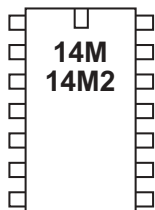
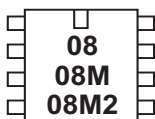

debug



Syntax:

DEBUG {var}

- Var is an optional variable value (e.g. b3). Its value is not of importance and is included purely for backwards compatibility with older programs.

Function:

Display variable information in the debug window when the debug command is processed. Byte information is shown in decimal, binary, hex and ASCII notation. Word information is shown in decimal and hex notation.

Information:

The debug command uploads the current variable values for *all* the variables via the download cable to the computer screen. This enables the computer screen to display all the variable values in the microcontroller for debugging purposes. Note that the debug command uploads a large amount of data and so significantly slows down any program loop.

To display user defined debugging messages use the 'sertxd' command instead.

Note that on 08 and 14 pin chips debug acts on 'B.0 / output 0'. Therefore programs that use output 0 may corrupt the serial data condition. In this case it is recommended to use the following structure before a debug command.

```
low B.0           ; reset B.0 to correct condition
pause 500        ; wait a while
debug            ; display values on computer screen
```

Example:

```
main:
inc b1           ; increment value of b1
readadc A.2,b2  ; read an analogue value
debug           ; display values on computer screen
pause 500       ; wait 0.5 seconds
goto main       ; loop back to start
```

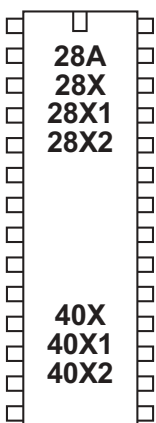
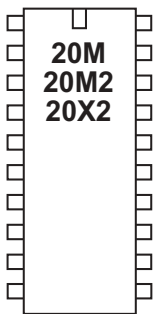
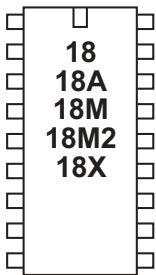
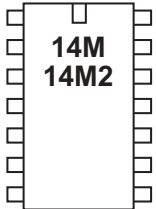
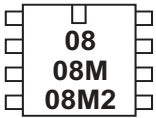
**dec***Syntax:***DEC var**

- var is the variable to decrement

Function:

Decrement (subtract 1 from) the variable value.

Information:

This command is shorthand for 'let var = var - 1'

Example:

```

let b2 = 10
for b1 = 1 to 5
  dec b2
next b1

```

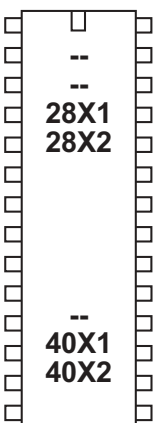
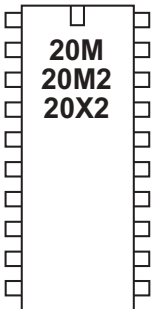
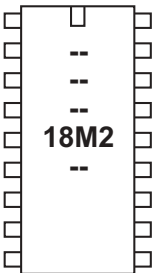
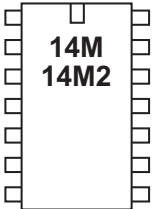
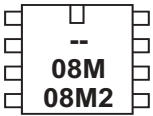

disablebod

Syntax:

DISABLEBOD

Function:

Disable the on-chip brown out detect function.

Information:

Some PICAXE chips have a programmable internal brown out detect function, to automatically cleanly reset the chip on a power brown out (a sudden voltage drop on the power rail). The brown out detect is always enabled by default when a program runs. However it is sometimes beneficial to disable this function to reduce current drain in battery powered applications whilst the chip is 'sleeping'.

The brownout voltage is fixed for each device as follows:

1.8V	28X2-3V, 40X2-3V
1.9V	20X2, 14M2, 18M2, 20M2, 28X2, 40X2
2.1V	08, 08M, 14M, 20M, 28X1, 40X1
2.3V	08M2
3.2V	28X2-5V, 40X2-5V
None	18, 18A, 18M, 18X, 28A, 28X, 40X

Use of the disablebod command prior to a sleep will considerably reduce the current drawn during the actual sleep command.

Example:

```
main: disablebod      ; disable brown out
      sleep 10        ; sleep for 23 seconds (2.3x10)
      enablebod       ; enable brown out
      goto main       ; loop back to start
```

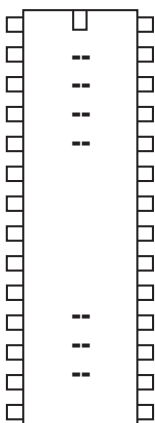
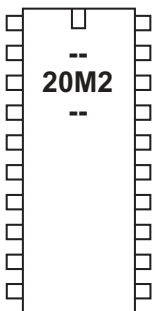
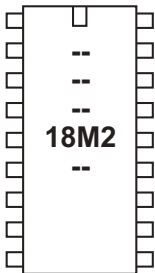
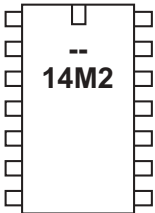
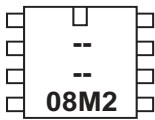
disabletime

Syntax:

DISABLETIME

Function:

Disable the elapsed time counter.

Information:

The M2 series have an internal elapsed time counter. This is a word variable called 'time' which increments once per second. This seconds counter starts automatically on a power-on reset, but can also be enabled/disabled by the disabletime/enabletime commands.

Effect of increased clock speed:

The time function will work correctly at 4MHz or 16 MHz.

At 2MHz or 8MHz the interval will be 2s

At 16MHz the interval will be 0.5s

Example:

```
main: pause 5000
      disabletime    ; disable time
      pause 5000     ; wait 5 seconds
      enabletime     ; enable time
      debug          ; display time value
      goto main      ; loop back to start
```

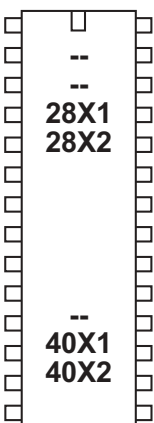
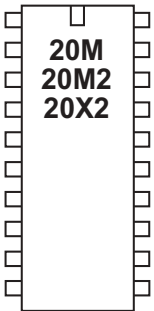
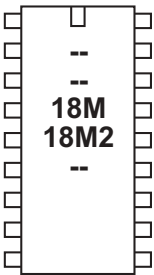
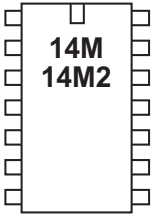
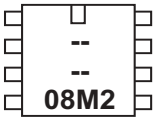

disconnect

Syntax:

DISCONNECT

Function:

Disconnect the PICAXE so that it does not scan for new downloads.

Information:

The PICAXE chips constantly scan the serial download pin to see if a computer is trying to initialise a new program download. However when it is desired to use the download pin for user serial communication (serrxd command), it is necessary to disable this scanning. Note that the serrxd command automatically includes a disconnect command.

After disconnect is used it will not be possible to download a new program until:

- 1) the reconnect command is issued
- 2) a reset command is issued
- 3) a hardware reset is carried out

Remember that it is always possible to carry out a new download by carrying out the 'hard-reset' procedure.

Example:

```
serrxd [1000, timeout],@ptrinc,@ptrinc,@ptr
reconnect
```

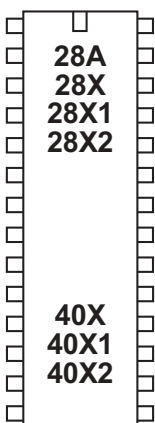
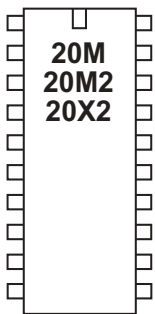
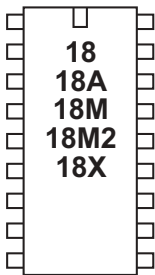
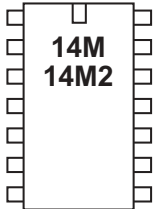
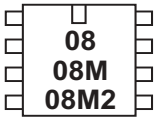

do...loop

Syntax:

```
DO
{code}
LOOP UNTIL/WHILE VAR ?? COND
```

```
DO
{code}
LOOP UNTIL/WHILE VAR ?? COND AND/OR VAR ?? COND...
```

```
DO UNTIL/WHILE VAR ?? COND
{code}
LOOP
```

```
DO UNTIL/WHILE VAR ?? COND AND/OR VAR ?? COND...
{code}
LOOP
```

- var is the variable to test

- cond is the condition

?? can be any of the following conditions

```
= equal to
is equal to
<> not equal to
!= not equal to
> greater than
< less than
```

Function:

Loop whilst a condition is true (while) or false (until)

Information:

This structure creates a loop that allows code to be repeated whilst, or until, a certain condition is met. The condition may be in the 'do' line (condition is tested before code is executed) or in the 'loop' line (condition is tested after the code is executed).

The exit command can be used to prematurely exit out of the do...loop.

Example:

```
do
  high B.1
  pause 1000
  low B.1
  pause 1000
  inc b2
  if pinC.1 = 1 then exit
loop while b2 < 5
```

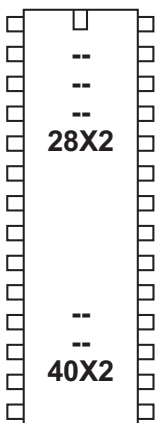
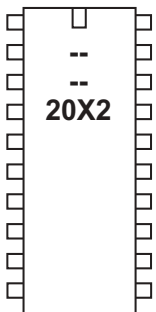
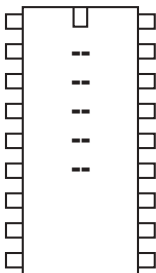
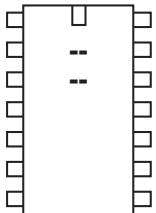
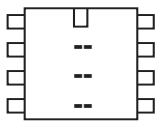

doze

Syntax:

DOZE period

- Period is a variable/constant which determines the duration of the reduced-power sleep (peripherals active).

Function:

Doze for a short period. Power consumption is reduced, but some timing accuracy is lost. Doze uses the same timeout frequency as sleep (2.1s).

Information:

The doze command puts the microcontroller into low power mode for a short period of time (like the sleep command). However, unlike the sleep command, all timers are left on and so the pwmout, timer and servo commands will continue to function. The nominal period of time is 2.1 seconds. Due to tolerances in the microcontrollers internal timers, this time is subject to -50 to +100% tolerance. The external temperature affects these tolerances and so no design that requires an accurate time base should use this command.

'doze 0' puts the microcontroller into permanent doze- it does not wake every 2.1 seconds. The microcontroller is only woken by a hardware interrupt (e.g. hint pin change or timer tick) or hard-reset. The chip will not respond to new program downloads when in permanent doze.

Effect of increased clock speed:

The doze command uses the internal timer which is not affected by changes in resonator clock speed.

Example:

```
main: high B.1           ; switch on output B.1
      doze 1             ; doze for 2.1 s
      low B.1           ; switch off output B.1
      doze 1             ; doze for 2.1 s
      goto main         ; loop back to start
```

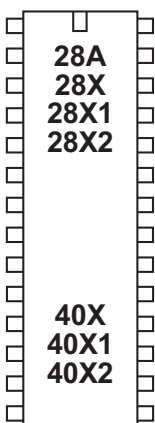
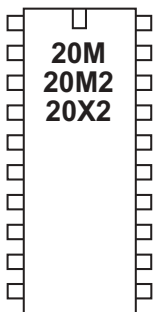
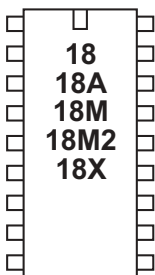
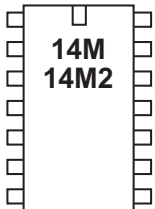
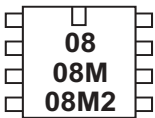

eeeprom (data)

Syntax:

DATA {location},{data,data...}

EEPROM {location},{data,data...}

- Location is an optional constant (0-255) which specifies where to begin storing the data in the EEPROM. If no location is specified, storage continues from where it last left off. If no location was initially specified, storage begins at 0.
- Data are constants (value 0-255) which will be stored in the EEPROM.

Function:

Preload EEPROM data memory. If no EEPROM command is used the values are automatically cleared to the value 0. The keywords DATA and EEPROM have identical functions and either can be used.

Information:

This is not an instruction, but a method of pre-loading the microcontrollers data memory. The command does not affect program length.

All current PICAXE chips have 256 bytes (address 0-255) of EEPROM memory. Only these older (discontinued) parts had less:

PICAXE-28, 28A	0 to 63
PICAXE-08, 18, 28X, 40X	0 to 127

Shared Memory Space:

With some PICAXE parts (listed below) the data memory is shared with program memory. Therefore only unused bytes may be used by the EEPROM command. To establish the length of the program use 'Check Syntax' from the PICAXE menu. This will report the length of program. Available data addresses can then be used as follows:

PICAXE-08 / 18	0 to (127 - number of used bytes)
PICAXE-08M	0 to (255 - number of used bytes)
PICAXE-14M / 20M	0 to (255 - number of used bytes)
PICAXE-18M	0 to (255 - number of used bytes)
PICAXE- 08M2 / 18M2 (not 18M2+)	Program 1792 up to 2048 is EEPROM 255 to 0 So on 08M2/older 18M2 all bytes are available if program is shorter than 1792 bytes long.

Example:

```
EEPROM 0,("Hello World")      ; save values in EEPROM

main:
  for b0 = 0 to 10             ; start a loop
    read b0,b1                 ; read value from EEPROM
    serout B.7,N2400,(b1)      ; transmit to serial LCD module
  next b0                      ; next character
```

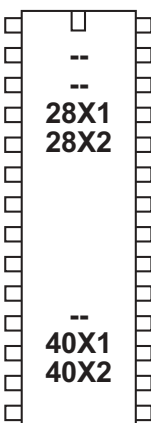
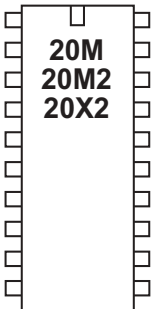
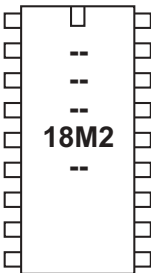
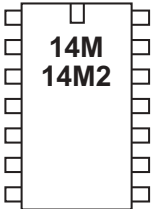
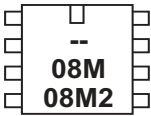

enablebod

Syntax:

ENABLEBOD

Function:

Enable the on-chip brown out detect function.

Information:

Some PICAXE chips have a programmable internal brown out detect function, to automatically cleanly reset the chip on a power brown out (temporary voltage drop). The brown out detect is always enabled by default when a program runs. However it is sometimes beneficial to disable this function to reduce current drain in battery powered applications whilst the chip is 'sleeping'.

The brownout voltage is fixed for each device as follows:

1.8V	28X2-3V, 40X2-3V
1.9V	20X2, 14M2, 18M2, 20M2, 28X2, 40X2
2.1V	08, 08M, 14M, 20M, 28X1, 40X1
2.3V	08M2
3.2V	28X2-5V, 40X2-5V
None	18, 18A, 18M, 18X, 28A, 28X, 40X

Use of the disablebod command prior to a sleep will considerably reduce the current drawn during the actual sleep command.

Example:

```
main: disablebod      ; disable brown out
      sleep 10        ; sleep for 23 seconds (10x2.3)
      enablebod       ; enable brown out
      goto main       ; loop back to start
```

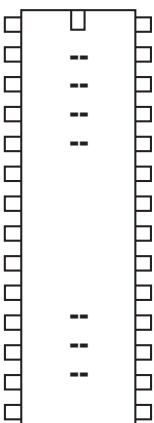
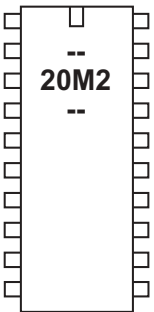
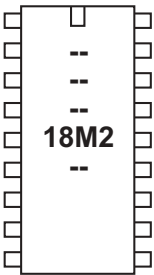
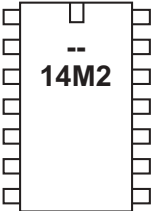
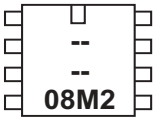

enabletime

Syntax:

ENABLETIME

Function:

Enable the elapsed time counter.

Information:

The M2 series have an internal elapsed time counter. This is a word variable called 'time' which increments once per second. This seconds counter starts automatically on a power-on reset, but can also be enabled/disabled by the disabletime/enabletime commands.

Effect of increased clock speed:

The time function will work correctly at 4MHz or 16 MHz.

At 2MHz or 8MHz the interval will be 2s

At 16MHz the interval will be 0.5s

Example:

```
main: pause 5000
      disabletime      ; disable time
      pause 5000      ; wait 5 seconds
      enabletime       ; enable time
      debug           ; display time value
      goto main       ; loop back to start
```

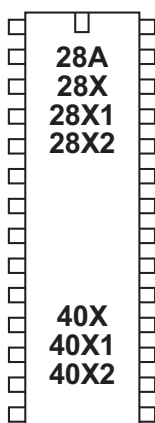
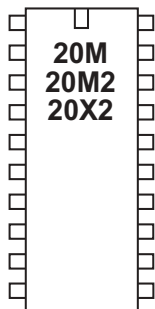
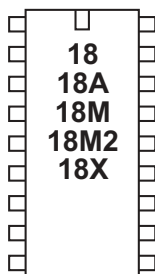
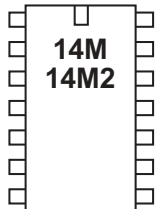
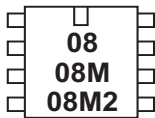

end

Syntax:

END

Function:

Sleep terminally until the power cycles (program re-runs) or the PC connects for a new download. Power is reduced to an absolute minimum (assuming no loads are being driven) and internal timers are switched off.

Information:

The end command places the microcontroller into low power mode after a program has finished. Note that as the compiler always places an END instruction after the last line of a program, this command is rarely required.

The end command switches off internal timers, and so commands such as servo and pwmout that require these timers will not function after an end command has been completed.

If you do not wish the end command to be carried out, place a 'stop' command at the bottom of the program. The stop command does not enter low power mode.

The main use of the end command is to separate the main program loop from sub-procedures as in the example below. This ensures that programs do not accidentally 'fall into' the sub-procedure.

Example:

```

main:
    let b2 = 15      ; set b2 value
    pause 2000      ; wait for 2 seconds
    gosub flsh      ; call sub-procedure
    let b2 = 5      ; set b2 value
    pause 2000      ; wait for 2 seconds
    end             ; stop accidentally falling into sub

flsh:
    for b0 = 1 to b2 ; define loop for b2 times
        high B.1     ; switch on output B.1
        pause 500    ; wait 0.5 seconds
        low B.1      ; switch off output B.1
        pause 500    ; wait 0.5 seconds
    next b0          ; end of loop
    return           ; return from sub-procedure
  
```

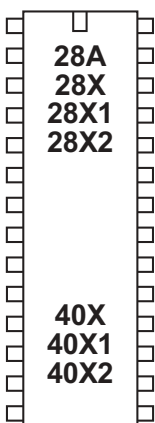
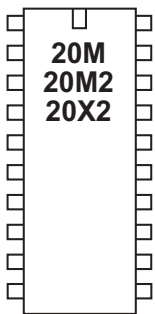
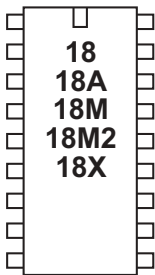
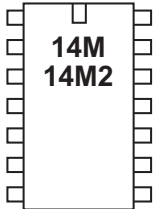
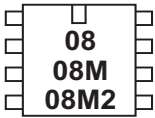
exit

Syntax:

EXIT

Function:

Exit is used to immediately terminate a do...loop or for...next program loop.

Information:

The exit command immediately terminates a do...loop or for...next program loop. It is equivalent to 'goto line after end of loop'.

Example:

```
main:
    do          ; start loop
    if b1 = 1 then
        exit
    end if
    loop       ; loop
```

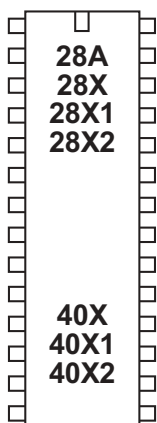
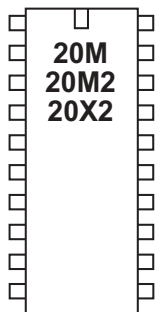
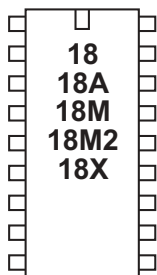
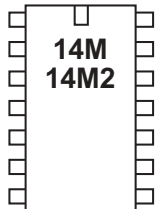
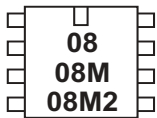

for...next

Syntax:

```
FOR variable = start TO end {STEP {-} increment}
  (other program lines)
NEXT {variable}
```

- Variable will be used as the loop counter
- Start is the initial value of variable
- End is the finish value of variable
- Increment is an optional value which overrides the default counter value of +1. If Increment is preceded by a '-', it will be assumed that Start is greater than End, and therefore increment will be subtracted (rather than added) on each loop.

Function:

Repeat a section of code within a FOR-NEXT loop.

Information:

For...next loops are used to repeat a section of code a number of times. When a byte variable is used, the loop can be repeated up to 255 times. Every time the 'next' line is reached the value of variable is incremented (or decremented) by the step value (+1 by default). When the end value is exceeded the looping stops and program flow continues from the line after the next command.

For...next loops can be nested 8 deep (remember to use a different variable for each loop).

The for...next loop can be prematurely ended by use of the exit command.

Example:

```
main:
  for b0 = 1 to 20 ; define loop for 20 times
    if pinC.1 = 1 then exit
    high B.1      ; switch on output B.1
    pause 500    ; wait 0.5 seconds
    low B.1     ; switch off output B.1
    pause 500   ; wait 0.5 seconds
  next b0       ; end of loop

  pause 2000   ; wait for 2 seconds
  goto main    ; loop back to start
```

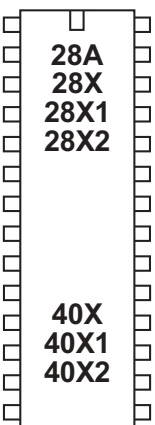
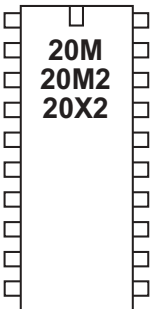
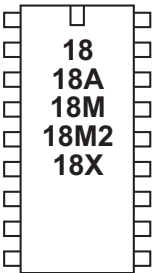
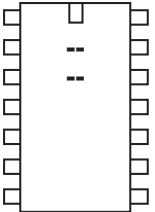
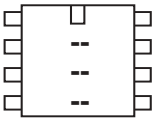

forward

Syntax:

FORWARD motor

- Motor is the motor name A or B.

Function:

Make a motor output turn forwards

Information:

This is a 'pseudo' command designed for use by younger students with pre-assembled classroom models. It is actually equivalent to 'high 4 : low 5' (motor A) or 'high 6 : low 7' (motor B). This command is not normally used outside the classroom.

Example:

```
main:
    forward A           ; motor a on forwards
    wait 5              ; wait 5 seconds
    backward A         ; motor a on backwards
    wait 5              ; wait 5 seconds
    halt A              ; motor A reverse
    wait 5              ; wait 5 seconds
    goto main           ; loop back to start
```

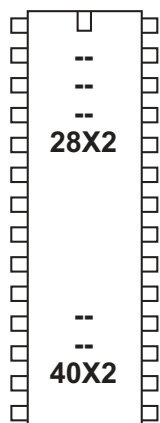
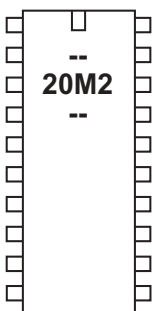
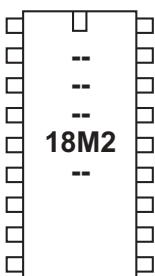
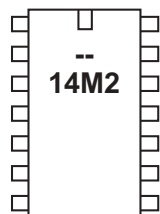
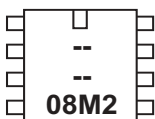

Firmware>=B.3

fvrsetup

Syntax:

```
FVRSETUP OFF  
FVRSETUP config
```

- config is a constant/variable specifying the fixed voltage reference FVR configuration

Function:

Configure the internal FVR fixed voltage reference

Information:

Some PICAXE chips have a fixed voltage reference.

This may be set off, or to one of three voltages by use of the constants

FVR1024	1.024V
FVR2048	2.048V
FVR4096	4.096V *

* Note the output of the FVR cannot exceed the supply voltage, so 4.096 is only available at a 5V supply.

Note that the 1.024V reference may not be used as the Vref+ of the ADC (only 2.048 or 4.096 may be used for this purpose). See the adconfig command for more details. To reduce power use the FVR module is also automatically disabled after a readadc command, so reissue the fvrsetup command again after the readadc if that feature is still required.

Note that the FVR voltage is reset to 1.024V via a 'calibadc' command.

The FVR may also be used as reference to the DAC (see the DACsetup command).

Example:

```
fvrsetup FVR1024 ; set to 1.024V
```

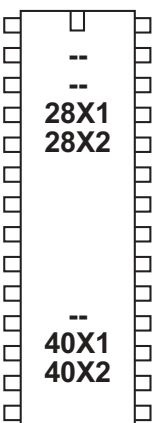
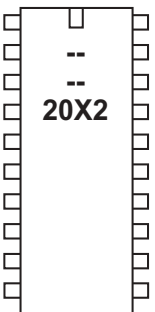
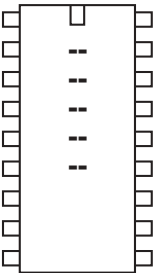
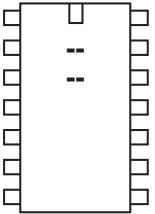
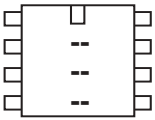

get

Syntax:

GET location,variable,variable,WORD wordvariable...

- Location is a variable/constant specifying a scratchpad address. Valid values are
 - 0 to 127 for X1 parts
 - 0 to 127 for 20X2 parts
 - 0 to 1023 for all other X2 parts
- Variable is a byte variable where the data is returned. To use a word variable the keyword WORD must be used before the wordvariable name)

Function:

Read data from the microcontroller scratchpad.

Information:

The function of the put/get commands is to store temporary byte data in the microcontrollers scratchpad memory. This allows the general purpose variables (b0, b1 etc) to be re-used in calculations.

Put and get have no effect on the scratchpad pointer and so the address next used by the indirect pointer (ptr) will not change during these commands.

When word variables are used (with the keyword WORD) the two bytes of the word are saved/retrieved in a little endian manner (ie low byte at address, high byte at address + 1)

Example:

```
get 1,b1           ; put value of register 1 into variable b1
get 1, word w1
```

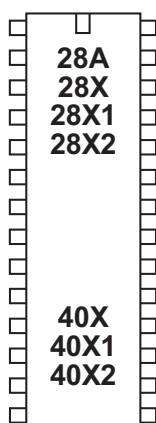
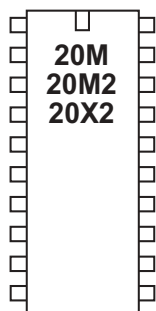
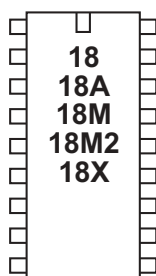
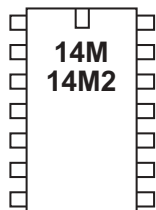
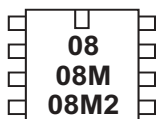

gosub (call)



Syntax:

GOSUB address

- Address is a label which specifies where to gosub to.

Function:

Go to sub procedure at 'address', then 'return' at a later point.
The compiler also accepts 'call' as a pseudo for 'gosub'.

Information:

The gosub ('goto subprocedure') command is a 'temporary' jump to a separate section of code, from which you will later return (via the return command). Every gosub command **MUST** be matched by a corresponding return command. Do not confuse with the 'goto' command which is a permanent jump to a new program location.

The table shows the maximum number of gosubs available in each microcontroller. Gosubs can normally be nested up to 8 levels deep (ie there is a 8 level stack available in the microcontroller).

	gosubs	interrupt	stack depth
All 'M2' parts *	255	1	8
All 'X2' parts	255	1	8
All 'X1' parts	255	1	8
All 'X' parts (obsolete)	255	1	4
All 'M' parts	15	1	4
All 'A' parts (obsolete)	16	0	4

* On 'parallel tasking' M2 parts each task has its own separate 8 deep stack.

Sub procedures are commonly used to reduce program space usage by putting repeated sections of code in a single sub-procedure. By passing values to the sub-procedure within variables, you can repeat a section of code from multiple places within the program. See the sample below for more information.

Example:

```

main:
    let b2 = 15      ; set b2 value
    gosub flsh      ; call sub-procedure
    let b2 = 5      ; set b2 value
    gosub flsh      ; call sub-procedure
    end             ; stop accidentally falling into sub

flsh:
    for b0 = 1 to b2 ; define loop for b2 times
        high B.1    ; switch on output 1
        pause 500   ; wait 0.5 seconds
        low B.1     ; switch off output 1
        pause 500   ; wait 0.5 seconds
    next b0         ; end of loop
    return          ; return from sub-procedure
  
```

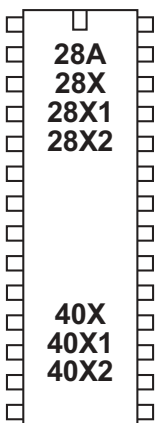
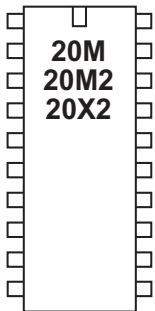
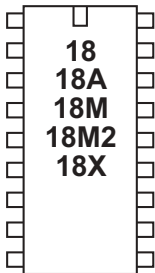
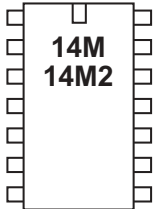
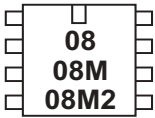
**goto***Syntax:***GOTO address**

- Address is a label which specifies where to go.

Function:

Go to address.

Information:

The goto command is a permanent 'jump' to a new section of the program. The jump is made to a label.

Example:

```

main:
    high B.1           ; switch on output 1
    pause 5000        ; wait 5 seconds
    low B.1           ; switch off output 1
    pause 5000        ; wait 5 seconds
    goto main         ; loop back to start
  
```



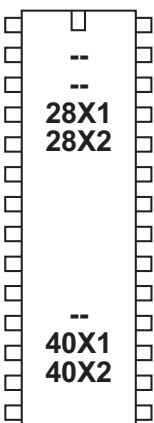
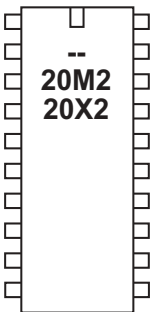
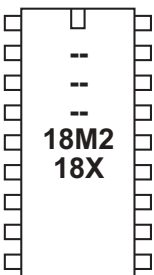
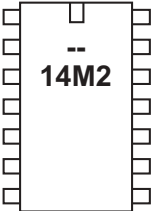
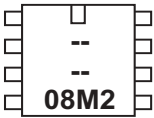

hi2cin

Syntax:

HI2CN (variable,...)

HI2CN location,(variable,...)

HI2CN [newslave],(variable,...) (X2 parts only)

HI2CN [newslave],location,(variable,...) (X2 parts only)

- Location is an optional variable/constant specifying a byte or word address.
- Variable(s) receives the data byte(s) read.
- Newslave is an optional new slave address for this (and all future) commands.

Function:

Read i2c location contents into variable(s).

Information:

Use of i2c parts is covered in more detail in the separate 'i2c Tutorial' datasheet.

This command is used to read byte data from an i2c device. Location defines the start address of the data read, although it is also possible to read more than one byte sequentially (if the i2c device supports sequential reads).

Location must be a byte or word as defined within the hi2csetup command. An hi2csetup command must have been issued before this command is used. The hi2csetup command sets the default slave address for this command. However when addressing multiple parts it may be necessary to repeatedly change the default slave address. This can be achieved via the optional [newslave] variable.

If the i2c hardware is incorrectly configured, or the wrong i2cslave data has been used, the value 255 (\$FF) will be loaded into each variable.

Example:

```
; Example of how to use DS1307 Time Clock
; Note the data is sent/received in BCD format.

; set PICAXE as master and DS1307 slave address
    hi2csetup i2cmaster, %11010000, i2cslow, i2cbyte

; read time and date and debug display

main:
    hi2cin 0, (b0,b1,b2,b3,b4,b5,b6,b7)
    debug b1
    pause 2000
    goto main
```



Hi2cIn \$AA,(b0)



Hi2cIn (b0) : Pause 20 : Hi2cIn \$A9,(b0)

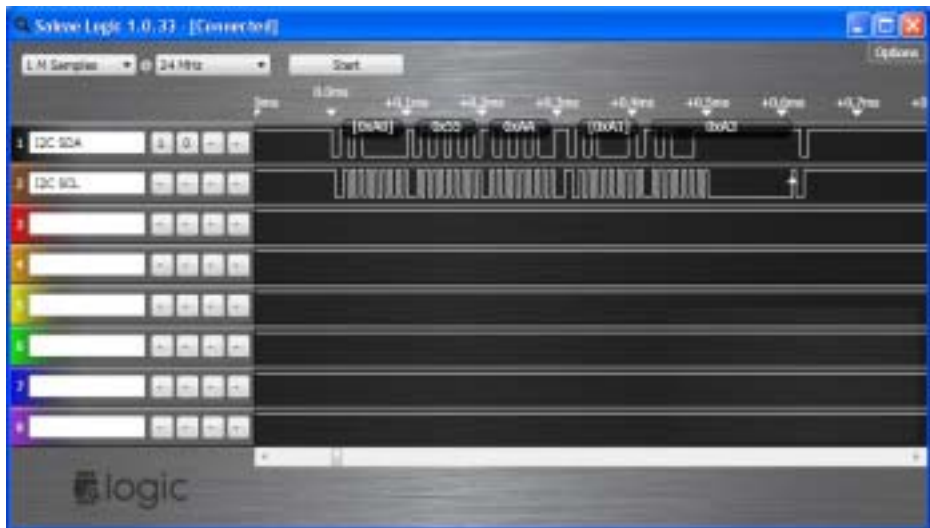

Hi2cIn \$55AA,(b0)



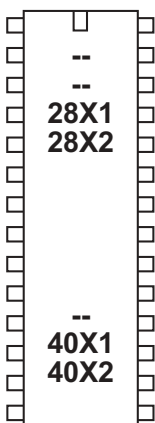
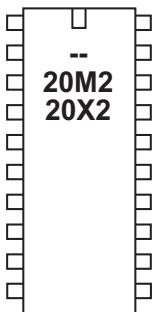
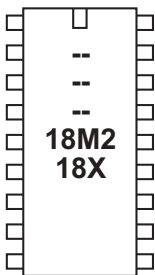
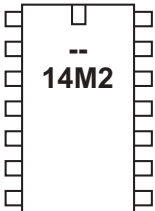
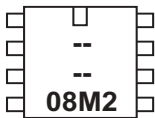

hi2cout

Syntax:

HI2COUT location,(variable,...)

HI2COUT (variable,...)

HI2COUT [newslave],location,(variable,...) (X2 parts only)

HI2COUT [newslave],(variable,...) (X2 parts only)

- Location is a variable/constant specifying a byte or word address.
- Variable(s) contains the data byte(s) to be written.
- Newslave is an optional new slave address for this (and all future) commands.

Function:

Write to i2c bus when acting as an i2c master device.

Information:

Use of i2c parts is covered in more detail in the separate 'i2c Tutorial' datasheet.

This command is used to write byte data to an i2c slave. Location defines the start address of the data to be written, although it is also possible to write more than one byte sequentially (if the i2c device supports sequential writes).

Location must be a byte or word as defined within the hi2csetup command. A hi2csetup command must have been issued before this command is used. The hi2csetup command sets the default slave address for this command. However when addressing multiple parts it may be necessary to repeatedly change the default slave address. This can be achieved via the optional [newslave] variable.

Example:

```
; Example of how to use DS1307 Time Clock
; Note the data is sent/received in BCD format.
; Note that seconds, mins etc are variables that need
; defining e.g. symbol seconds = b0 etc.

; set PICAXE as master and DS1307 slave address
      hi2csetup i2cmaster, %11010000, i2cslow, i2cbyte

; write time and date e.g. to 11:59:00 on Thurs 25/12/03
start_clock:
      let seconds = $00 ; 00 Note all BCD format
      let mins    = $59 ; 59 Note all BCD format
      let hour    = $11 ; 11 Note all BCD format
      let day     = $03 ; 03 Note all BCD format
      let date    = $25 ; 25 Note all BCD format
      let month   = $12 ; 12 Note all BCD format
      let year    = $03 ; 03 Note all BCD format
      let control = %00010000 ; Enable output at 1Hz
```

```
hi2cout 0, (seconds,mins,hour,day,date,month,year,control)
```

```
end
```

Hi2cOut \$AA,(\$A3)



Hi2cOut (\$F3)

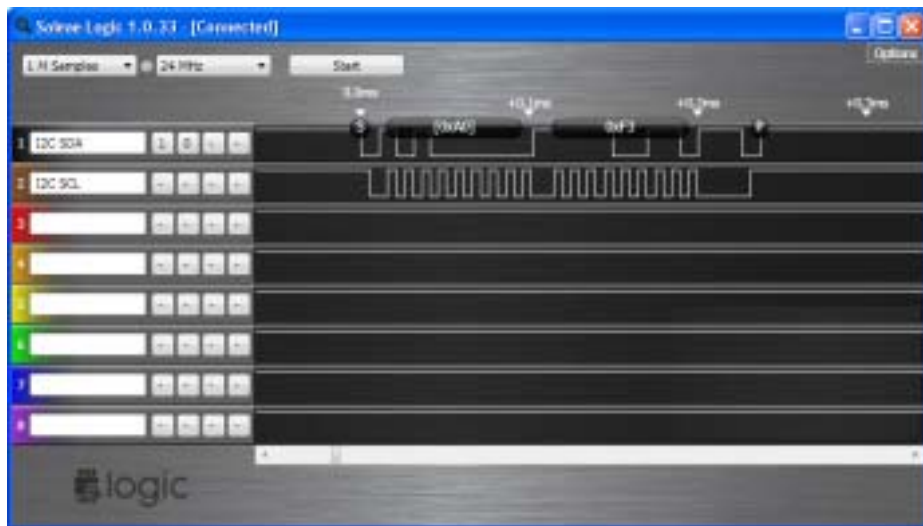

Hi2cOut \$55AA,(\$A3)



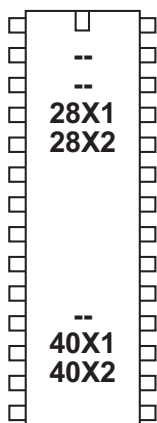
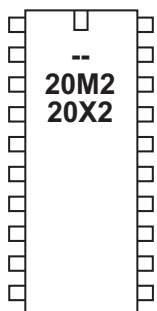
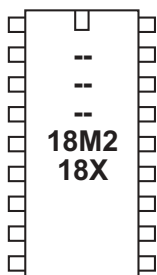
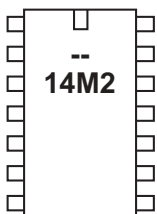
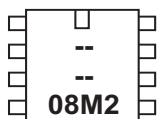

hi2csetup

Syntax:

HI2CSETUP OFF

HI2CSETUP I2CSLAVE, slaveaddress

HI2CSETUP I2CMASTER, slaveaddress, mode, addresslen

Master mode is when the PICAXE controls the i2c bus. It controls other 'slave' devices like memory EEPROMS and can 'talk' to any device on the i2c bus. Slave mode is when the PICAXE is controlled by a different master device (e.g. another microcontroller). It cannot talk to other devices on the i2c bus.

- SlaveAddress is the i2c slave address
- Mode is the keyword `i2cfast` (400kHz) or `i2cslow` (100kHz). Note that these keywords must change to `i2cfast_8`, `i2cslow_8` at 8MHz, etc.
- Addresslen is the keyword `i2cbyte` or `i2cword`. Note that this is the 'addressing method' used by the i2c device (i.e. some EEPROMs use a byte address, some use a word address). It is NOT the length of data returned by the `hi2cin` command, which is always a byte.

Function:

The `hi2csetup` command is used to configure the PICAXE pins for i2c use and to define the type of i2c device to be addressed.

Description:

Use of i2c parts is covered in more detail in the separate 'i2c Tutorial' datasheet.

hi2csetup - slave mode (X2 parts only)

Slave Address

The slave address is the address that is used by the PICAXE chip for identification. It can be a number between 1 and 127, but must be held in bits 7 to 1 of the address (not bits 6 - 0) e.g. `%1010000x`. Bit0 is the read/write bit and so ignored. If you are not sure which address to use we recommend the 'standard i2c EEPROM' address which is `%10100000`. Some special i2c addresses (0, `%1111xxx`, `%0000xxxx`) have special meanings under the i2c protocol and so are not recommended as they may cause unexpected behaviour on third party devices.

Description:

When in slave mode all i2c functions of the slave PICAXE chip are completely automatic. An i2c master can read or write to the slave PICAXE chip as if it was a 128 (X1, 20X2) or 256 (X2) byte 24LCxx series EEPROM, with the scratchpad area acting as the memory transfer area. The master can read the slave PICAXE chip at any time. This does not have any noticeable effect on the slave PICAXE program, however commands that disable internal hardware interrupts (e.g. `serout` etc) may affect operation. See appendix 2 for more detail on possible conflicts.

However when the master writes to the slave PICAXE memory the 'hi2cflag' is set and the last address written to is saved in the 'hi2clast' variable. Therefore by polling the hi2cflag bit (or using setintflags to cause an interrupt) the PICAXE program can take action when a write has occurred. The hi2cflag must be cleared by the user program after use.

Example:

The following examples show how to use two PICAXE-28X1 chips, one as a master and one as a slave. The slave acts as an output expander for the master.

Slave code:

```
init: hi2csetup i2cslave, %10100000
```

```
main:
```

```
    if hi2cflag = 0 then main      ; poll flag, else loop
```

```
    hi2cflag = 0                  ; reset flag
```

```
    get hi2clast,b1               ; get last byte written
```

```
    let outpins = b1              ; set output pins
```

```
    goto main
```

Master code:

```
init: hi2csetup i2cmaster, %10100000, i2cslow, i2cbyte
```

```
main:
```

```
    inc b1                        ; increment variable
```

```
    hi2cout 0,(b1)                ; send value to byte 0 on slave
```

```
    pause 500                      ; wait a while
```

```
    goto main
```

hi2csetup - master mode

If you are using a single slave i2c device alongside your PICAXE master you generally only need one hi2csetup command within a program. After the hi2csetup has been issued, hi2cin and hi2cout can be used to access the slave i2c device. When using multiple devices you can change the default slave address within the hi2cin or hi2cout command.

Slave Address

The slave address varies for different i2c devices (see table below). For the popular 24LCxx series serial EEPROMs the address is commonly %1010xxxx.

Note that some devices, e.g. 24LC16B, incorporate the block address (ie the memory page) into bits 1-3 of the slave address. Other devices include the external device select pins into these bits. In this case care must be made to ensure the hardware is configured correctly for the slave address used.

Bit 0 of the slave address is always the read/write bit. However the value entered using the i2cslave command is ignored by the PICAXE, as it is overwritten as appropriate when the slave address is used within the readi2c and writei2c commands.

Most datasheets give the slave address in 8 bit format e.g.

1010000x - where x is don't care (the read/write bit, PICAXE controlled)

However some datasheets use a 7 bit format. In this case the bits must be shifted left to take account for the read/write bit.

Speed

Speed of the i2c bus can be selected by using one of the keywords i2cfast or i2cslow (400kHz or 100kHz). The internal slew rate control of the microcontroller is automatically enabled when required. Always use the SLOWEST speed of the devices on a bus - do not use i2cfast if any part is a 100KHz part (e.g. DS1307).

Effect of Increased Clock Speed:

Ensure you modify the speed keyword (i2cfast_8, i2cslow_8) at 8MHz or (i2cfast_16, i2cslow_16) at 16MHz for correct operation.

Address Length

i2c devices commonly have a single byte (i2cbyte) or double byte (i2cword) address. This must be correctly defined for the type of i2c device being used. If you use the wrong definition erratic behaviour will be experienced.

When using the i2cword address length you must also ensure the 'address' used in the hi2cin and hi2cout commands is a word variable.

Settings for some common parts:

Device	Type	Slave	Speed	Address
24LC01B	EE 128	%1010xxxx	i2cfast	i2cbyte
24LC02B	EE 256	%1010xxxx	i2cfast	i2cbyte
24LC04B	EE 512	%1010xxbx	i2cfast	i2cbyte
24LC08B	EE 1kb	%1010xbbx	i2cfast	i2cbyte
24LC16B	EE 2kb	%1010bbbx	i2cfast	i2cbyte
24LC64	EE 8kb	%1010dddx	i2cfast	i2cword
24LC128	EE 16kb	%1010dddx	i2cfast	i2cword
24LC256	EE 32kb	%1010dddx	i2cfast	i2cword
24LC512	EE 64kb	%1010dddx	i2cfast	i2cword
DS1307	RTC	%1101000x	i2cslow	i2cbyte
MAX6953	5x7 LED	%101dddx	i2cfast	i2cbyte
AD5245	Digital Pot	%010110dx	i2cfast	i2cbyte
SRF08	Sonar	%1110000x	i2cfast	i2cbyte
AXE033	I2C LCD	\$C6	i2cslow	i2cbyte
CMPS03	Compass	%1100000x	i2cfast	i2cbyte
SPE030	Speech	%1100010x	i2cfast	i2cbyte

x = don't care (ignored)

b = block select (selects internal memory page within device)

d = device select (selects device via external address pin polarity)

Effect of Increased Clock Speed:

Ensure you modify the mode keyword (i2cfast_8, i2cslow_8) at 8MHz or (i2cfast_16, i2cslow_16) at 16MHz for correct operation.

Advanced Technical Information:

Users familiar with assembler code programming may choose to create their own 'mode' settings to adjust the i2c communication speed. The mode value is a value between 0-127 that is the preload BRG value loaded into SSPADD. Bit 7 of the mode byte is used to set/clear the SSPSTAT,SMP slew control bit.

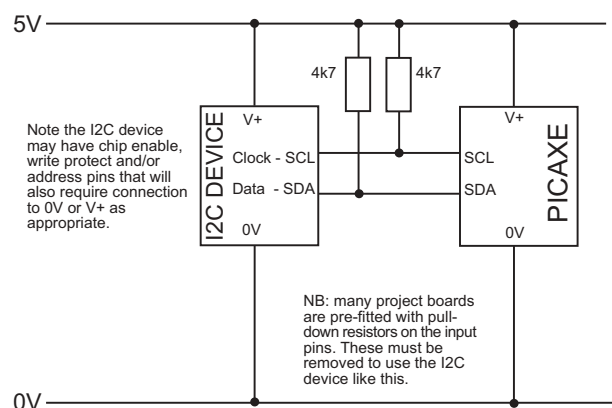

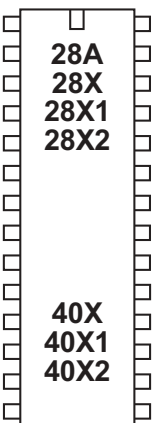
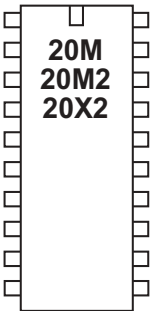
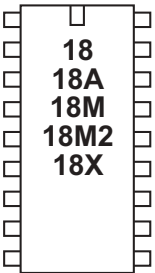
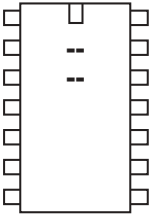
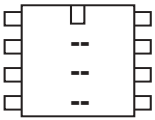

halt

Syntax:

HALT motor

- Motor is the motor name A or B.

Function:

Make a motor output stop.

Information:

This is a 'pseudo' command designed for use by younger students with pre-assembled classroom models. It is actually equivalent to 'low 4 : low 5' (motor A) or 'low 6 : low 7' (motor B). This command is not normally used outside the classroom.

Example:

```
main: forward A           ; motor a on forwards
      wait 5              ; wait 5 seconds
      backward A         ; motor a on backwards
      wait 5              ; wait 5 seconds
      halt A              ; motor A halt
      wait 5              ; wait 5 seconds
      goto main           ; loop back to start
```

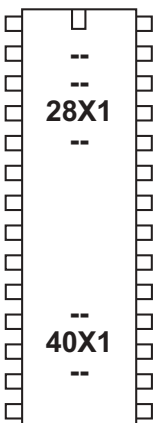
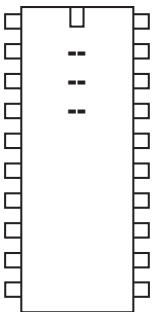
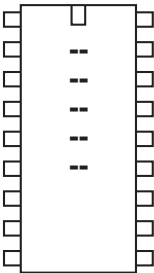
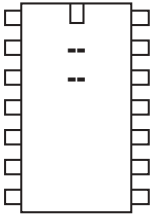
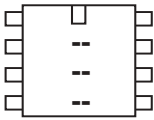
hibernate

Syntax:

HI BERNATE config

- config is a constant/variable that sets the type of hibernation

Function:

Make the microcontroller sleep until a reset or interrupt occurs.

Information:

The hibernate command puts the microcontroller into very low power 'hibernation' mode. Unlike the sleep command, which wakes up every 2.3s, hibernate mode enters a state of permanent sleep. The only way to exit this deep sleep is via an external reset or via a hardware interrupt (hserin, hi2cin, etc.). A new program download from the computer will NOT wake the microcontroller.

For best low power performance, ensure any unused inputs are tied high/low, and that no outputs are being actively driven. The hibernate command automatically shuts down any on-board peripherals (timers, pwm etc) and disables the brown out detect circuit (equivalent of an automatic 'disable bod' command). After a hibernate command the brown out detect is always re-enabled, so if the brown out detect feature is not required after the hibernate the user program must disable it again via a 'disablebod' command.

'config' value is used to disable/enable and set the 'ultra low power wake up feature' of analogue pin ADC0. A value of 0 disables this feature.. When enabled, the hibernate will terminate after a capacitor (connected to ADC0) has discharged. This is more energy efficient than using the sleep command.

A non-zero config value enables the ULPWU feature on ADC0, and the actual config value sets the charging time (in ms) for the connected capacitor. Therefore the hibernate command first charges the capacitor, then hibernates, and then wakes up again once the capacitor has discharged.

The discharge time is given by the following formula:

$$\text{Time} = ((\text{initial C voltage} - 0.6) * C) / (\text{sink current} + \text{leakage current})$$

The sink current is approximately 140nA with 5V power supply. Therefore the discharge time for a 200 ohm resistor and 1nF capacitor is approximately 30ms. This means the hibernate will end after approximately 30ms, although the discharge time is highly dependant on the capacitance (of the capacitor and circuit), and so, for example, long pcb tracks and moisture in the air can considerably affect these times.

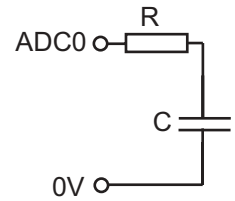

MANUAL WAKEUP - The capacitor can also be completely replaced by a push-to-make switch (use 1k resistor as R and add another 100k resistor from the top of the switch to V+ to act as a positive voltage pull-up). The switch then acts as a manual 'wake-up' switch.

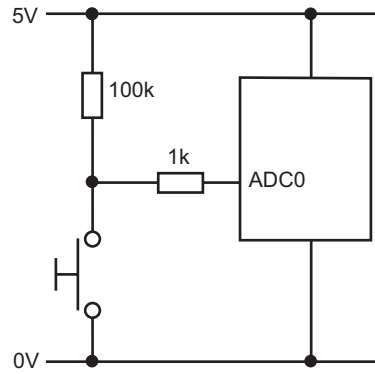

Note that the 1k is essential to prevent a possible short circuit situation (if the switch was pushed whilst the hibernate starts, as it will momentarily make ADC0 an output to 'charge the capacitor').

Example:

main:

```
toggle 1           ; toggle state of output 1
hibernate 50       ; hibernate after charging cap for 50ms
disablebod        ; turn bod off
goto main         ; loop back to start
```

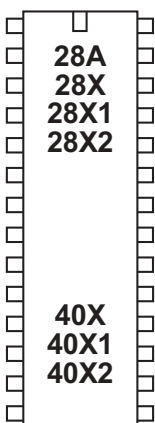
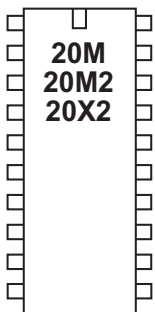
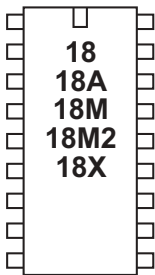
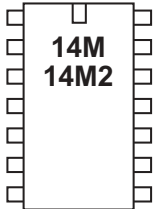
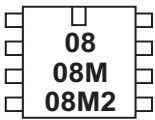

high



Syntax:

HIGH pin {,pin,pin..}

- Pin is a variable/constant which specifies the i/o pin to use.

Function:

Make pin an output and switch it high.

Information:

The high command switches an output on (high).

On microcontrollers with configurable input/output pins (e.g. PICAXE-08) this command also automatically configures the pin as an output.

Example:

```
main: high B.1           ; switch on output B.1
      pause 5000         ; wait 5 seconds
      low B.1            ; switch off output B.1
      pause 5000         ; wait 5 seconds
      goto main          ; loop back to start
```

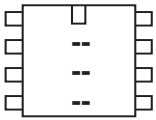

high portc

Syntax:

HIGH PORTCpin {,pin,pin...}

- Pin is a variable/constant (0-7) which specifies the i/o pin to use.

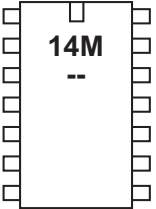

Function:

Make pin on portc output high.

This command is only used on older 14M and 28X/28X1 parts.

For newer M2 and X2 parts use the PORT.PIN notation directly e.g. high C.2

Information:

The high command switches a portc output on (high).

Example:

```
main: high portc 1      ; switch on output portC 1
      pause 5000        ; wait 5 seconds
      low portc 1       ; switch off output portC 1
      pause 5000        ; wait 5 seconds
      goto main         ; loop back to start
```

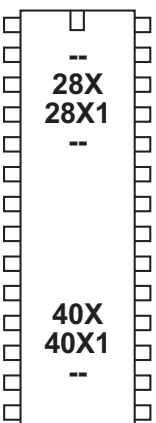
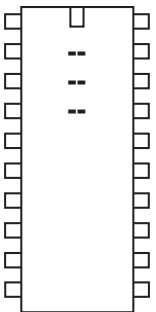
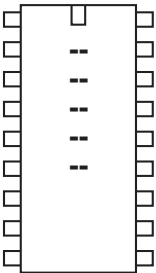

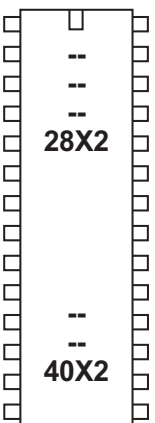
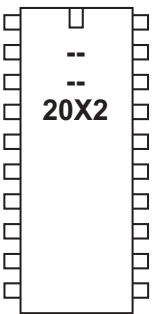
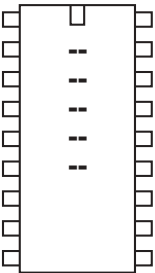
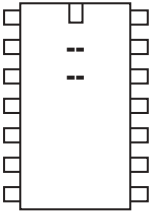
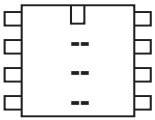

hintsetup

Syntax:

HINTSETUP mask

- mask is a variable/constant which defines which interrupt pins to activate.

- Bit 7 - reserved
- Bit 6 - Interrupt 2 Trigger (1 = rising edge, 0 = falling edge)
- Bit 5 - Interrupt 1 Trigger (1 = rising edge, 0 = falling edge)
- Bit 4 - Interrupt 0 Trigger (1 = rising edge, 0 = falling edge)
- Bit 3 - reserved
- Bit 2 - Interrupt 2 Enable
- Bit 1 - Interrupt 1 Enable
- Bit 0 - Interrupt 0 Enable (not available on 20X2)

Function:

The X2 parts have up to 3 hardware interrupts pin (INT0, INT1, INT2) which are activated/deactivated by the hintsetup command. The hardware interrupt pins constantly background monitor for an edge based trigger. As they operate in the background the PICAXE program does not have to poll the input to detect a change in state.

The hardware interrupts are triggered and processed extremely quickly. Therefore be aware of, for instance, switch contact bounce, which may give unexpected results if not debounced by software and/or hardware.

The hardware interrupt pins can also wake a PICAXE microcontroller from sleep/ doze mode.

Information:

The hardware interrupt pins cause an instant change in the hardware interrupt flags upon input pin condition change.. If a setintflags command has also been issued, a PICAXE program interrupt may then occur.

Activation of each individual pin sets two flags, its own unique flag and the shared 'hintflag'. The flags must be cleared manually in the user's PICAXE program. The hintsetup command enables the hardware setting of the flags only, it does not trigger an actual PICAXE program interrupt.

Therefore to have the PICAXE program call the "interrupt:" section of code upon a hardware pin interrupt you must follow two steps:

- 1) use 'hintsetup' to allow hardware flag setting
- 2) then use 'setintflags' to actually generate an interrupt upon the setting of those flags. This means it is possible to interrupt on a combination of any, or all, of the flags via use of the setintflags command. See the setintflags command description for more details.

Example:

```
hintsetup %00000111 ; enable all 3 pins
hintsetup %00000010 ; enable INT1 only
hintsetup %00000000 ; disable all pins
```

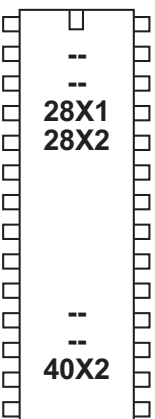
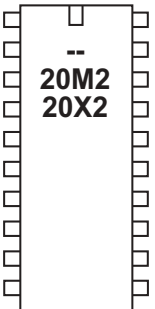
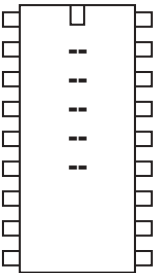
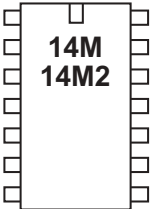
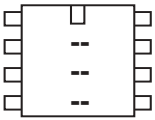

hpwm

Syntax:

HPWM mode, polarity, setting, period, duty

HPWM DIV4, mode, polarity, setting, period, duty

HPWM DIV16, mode, polarity, setting, period, duty

HPWM DIV64, mode, polarity, setting, period, duty

HPWM OFF

- Mode is a variable/constant which specifies the hardware pwm mode

pwmsingle	- 0
pwmhalf	- 1
pwmfull_f	- 2
pwmfull_r	- 3
- polarity is a variable/constant which specifies the active polarity (DCBA)

pwmHHHH	- 0
pwmLHLH	- 1
pwmHLHL	- 2
pwmLLLL	- 3
- setting is a variable/constant which specifies a specific setting

single mode	- bit mask %0000 to %1111 to dis/enable DCBA
half mode	- dead band delay (value 0-127)
full mode	- not used, enter 0 as default value
- Period is a variable/constant (0-255) which sets the PWM period (period is the length of 1 on/off cycle i.e. the total mark:space time).
- Duty is a variable/constant (0-1023) which sets the PWM duty cycle. (duty cycle is the mark or 'on time')

The PWMDIV keyword is used to divide the frequency by 4, 16 or 64. This slows down the PWM. 64 is not supported by all parts.

Note that the 'PWMout Wizard' from the PICAXE>Wizards menu in the Programming Editor or AXEpad software can also be used to calculate hpwm frequencies. See the 'pwmout' command for more details about this wizard.

28 pin devices - the 28X1, 28X2, 28X2-3V support hpwm, the 28X2-5V does not.

40 pin devices - the 40X2, 40X2-5V and 40X2-3V parts support hpwm, the 40X1 does not.

This is a design restriction of the silicon within these particular chips.

Function:

Hardware PWM is an advanced method of motor control using PWM methods. It can use a number of outputs and modes, as defined by the PIC microcontroller's internal pwm hardware.

hpwm can be used **instead of, not at the same time as**, the pwmout command on 2 (28/40 pin). However pwmout on 1 can be used simultaneously if desired.

Description:

hpwm gives access to the advanced pwm controller in the PIC microcontroller. It uses up to 4 pins, which are labelled here A,B,C,D for convenience.. Some of these pins normally 'default' to input status, in this case they will automatically be converted to outputs when the hpwm command is processed.

On 20 pin devices:

A is input 5 (C.5)
 B is input 4 (C.4)
 C is input 3 (C.3)
 D is output 4 (B.4)

On 14 pin devices:

A is input 2 (C.5)
 B is input 1 (C.4)
 C is input 0 (C.3)
 D is output 5 (C.2)

On 28 pin devices:

A is input 2 (C.2)
 B is output 2 (B.2)
 C is output 1 (B.1)
 D is output 4 (B.4)

On 40 pin devices:

A is portC 2 (C.2)
 B is input 5 (D.5)
 C is input 6 (D.6)
 D is input 7 (D.7)

Not all pins are used in all hpwm modes. Unused bits are left as normal i/o pins.

single - A and/or B and/or C and/or D (each bit is selectable)

half - A, B only

full - A, B, C, D

The active polarity of each pair of pins can be selected by the polarity setting:

pwm_HHHH - A and C active high, B and D active high

pwm_LLHH - A and C active high, B and D active low

pwm_HLHL - A and C active low, B and D active high

pwm_LLLL - A and C active low, B and D active low

When using active high outputs, it is important to use a pull-down resistor from the PICAXE pin (A-D) to 0V. When using active-low outputs a pull-up resistor is essential. The purpose of the pull-up/down resistor is to hold the FET driver in the correct state whilst the PICAXE chip initialises upon power up. During this short initialisation period the drivers are not actively driven (ie they 'float') and so the resistor is essential to hold the FET in the required off condition.

Single Mode

Supported: 20X2, 28X1, 28X2, 28X2-3V, 40X2, 40X2-3V

Not Supported: 14M, 14M2, 20M2, 28X2-5V, 40X1, 40X2-5V

In single mode each pin works independently. It is therefore equivalent to a pwmout command. However more than one pin can be enabled at a time. Therefore this mode has two main uses:

- 1) To allow the equivalent of a 'pwmout' command on different outputs (than the pwmout command)
- 2) To allow pwmout on more than one pin (up to 4) at the same time. The pwmout applied to each output is identical. This is often used to provide a brightness control on multiple LEDs or to control multiple motors.

To enable a single output simply set its corresponding bit to '1' (D-C-B-A) within the settings byte of the command e.g. to enable all 4 pins use %1111

Half Mode (all parts)

In half mode outputs A and C control a half bridge. C and D are not used. The PWM signal is output on pin A, while the complementary PWM signal is output on pin B. The dead band delay 'setting' value is a very important value, without a correct value a shoot-through current may destroy the half bridge setup. This delay prevents both outputs being active at the same time. The command delay value (0-127) gives a delay equivalent to $(\text{value} \times \text{oscillator speed (e.g. 4MHz)}) / 4$. The value depends on the switch on/off characteristics of the FET drivers used.

See the hpwm motor driver datasheet for more details.

Full Mode (all parts)

In full bridge mode outputs A, B, C and D control a full bridge.

In forward mode A is driven to its active state whilst D is modulated. B and C are in their inactive state.

In reverse mode C is driven to its active state whilst B is modulated. A and D are in their inactive state.

In this mode a deadband delay is generally not required as only one output is modulated at one time. However there can be conditions (when near 100% duty cycle) where current shoot-through could occur. In this case it is recommended to either 1) switch off pwm before changing directions or 2) use a specialist FET driver that can switch the FET on quicker than it switches off (the opposite is normally true on non-specialist parts).

See the hpwm motor driver datasheet for more details.

hpwm single mode

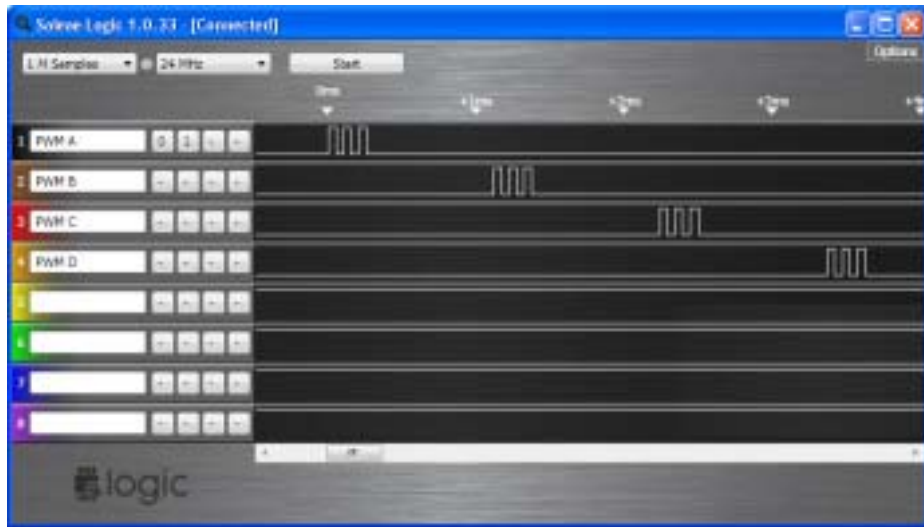

hpwm full mode



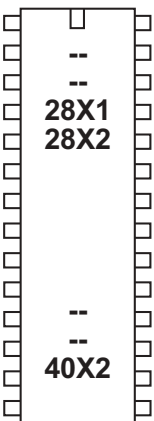
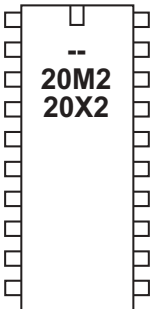
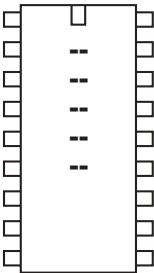
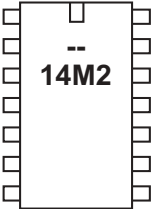
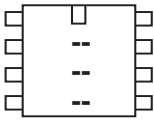

hpwm duty

Syntax:

HPWMDUTY duty cycles

- Duty is a variable/constant (0-1023) which sets the PWM duty cycle. (duty cycle is the mark or 'on time')

Function:

Alter the duty cycle after a hpwm command has been issued.

Information:

The hpwm duty command can be used to alter the hpwm duty cycle without resetting the internal timer (as occurs with a hpwm command). A hpwm command must be issued before this command will function.

Information:

See the hpwm command for more details.

Example:

init:

```
hpwm 0,0,%1111,150,100 ; start pwm
```

main:

```
hpwm duty 150           ; set pwm duty
pause 1000              ; pause 1 s
hpwm duty 50            ; set pwm duty
pause 1000              ; pause 1 s
goto main               ; loop back to start
```

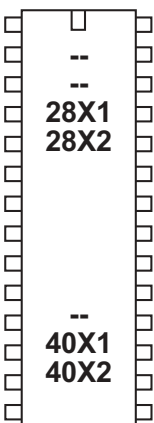
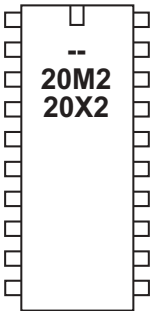
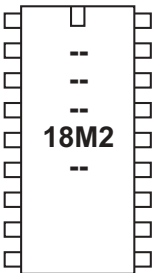
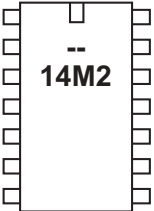
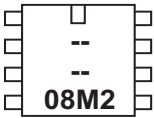

hserin

Syntax (X2 parts):

HSERIN spaddress, count {,(qualifier)}

HSERIN [timeout, address], spaddress, count {,(qualifier)}

- Qualifier is an optional single variable/constant (0-255) which must be received before subsequent bytes can be received and stored in scratchpad
- Spaddress is the first scratchpad address where bytes are to be received
- Count is the number of bytes to receive
- Timeout is an optional variables/constants which sets the timeout period in milliseconds
- Address is a label which specifies where to go if a timeout occurs.

Syntax (M2 parts):

HSERIN var

- Var is a variable to receive the data byte.

Function:

Serial input via the hardware serial input pin (format 8 data, no parity, 1 stop).

Information:

The hserin command is used to receive serial data from the fixed hardware serial input pin of the microcontroller. It cannot generally be used with the serial download input pin - use the serrxd command in this case.

Baud rate is defined by the hsersetup command, which must be issued before this command can be used.

Users familiar with the serin command will note the hserin command has a completely different format. This is because the hserin command supports much higher baud rates than serin, and so is unable to process received bytes 'on the fly' (e.g. by changing ASCII into binary, as with the serin # prefix), as there is insufficient time for this processing to occur before the next hserin byte is received (at high baud rates). Therefore the raw data is simply saved in the memory and the user program must then process the raw data when all the bytes have been received.

Example - X2 parts:

Note that on X2 parts you may prefer to background receive the serial data into the scratchpad (hence not requiring use of this command at all) - see the hsersetup command for more details (hserin only accepts data when the command is being processed - background receive accepts data all the time).

```

hsersetup B19200_16, %00 ; baud 19200 at 16Mhz
main:
hserin [1000,main],0,4 ; receive 4 bytes into sp
ptr = 0 ; reset sp pointer
hserout 0,(@ptrinc,@ptrinc,@ptrinc,@ptr) ; echo out
goto main ; loop

```

Example - M2 parts:

On M2 parts the hserin command is used to transfer background received bytes into a variable. Up to two bytes can be 'background received' at any time during the PICAXE program (not just when the hserin command is processing) and are temporarily stored in a 2 deep FIFO buffer. Any more than two bytes are lost.

Therefore on M2 parts the hserin command is non-blocking, it always processes immediately. If there is received data in the internal buffer the first byte is copied into the variable, if not the variable is left unaltered and the program continues on the next line. If two bytes are expected in the buffer it is necessary to use two separate hserin commands to retrieve both bytes.

```
        hsersetup    B9600_4, %00        ; baud 9600 at 4MHz
main:
        w1 = $FFFF        ; set up a non-valid value
        hserin w1        ; receive 1 byte into w1
        if w1 <> $FFFF then        ; if a byte was received
            hserout 0, (w1)        ; echo it back out
        end if
        goto main        ; loop
```

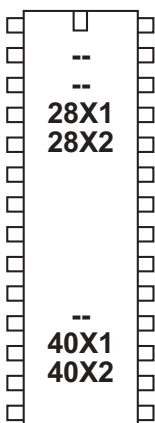
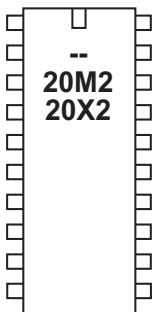
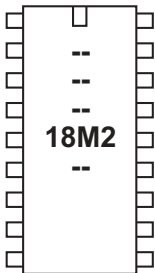
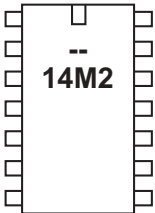
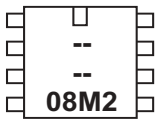

hserout

Syntax:

HSEROUT break, ({#}data,{#}data...)

- Break is a variable/constant (0 or 1) which indicates whether to send a 'break' (wake-up) signal before the data is sent.
- Data are variables/constants (0-255) which provide the data to be output. Optional #'s are for outputting ASCII decimal numbers, rather than raw characters. Text can be enclosed in speech marks ("Hello")

Function:

Transmit serial data via the hardware serial output pin (8 data bits, no parity, 1 stop bit).

Information:

The hserout command is used to transmit serial data from the fixed hardware serial output pin of the microcontroller. It cannot be used with the serial download output pin - use the sertxd command in this case.

Polarity and baud rate are defined by the hsersetup command, which must be issued before this command can be used.

The # symbol allows ASCII output. Therefore #b1, when b1 contains the data 126, will output the ASCII characters "1" "2" "6" rather than the raw data byte '126'.

Example:

```

hsersetup B2400_4, %10 ; 2400 baud, inverted polarity
main:
  for b0 = 0 to 63 ; start a loop
    read b0,b1 ; read value into b1
    hserout 0,(b1) ; transmit value to serial LCD
  next b0 ; next loop

```

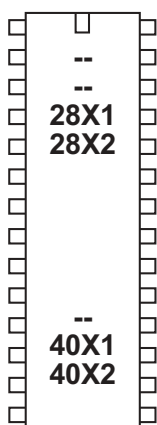
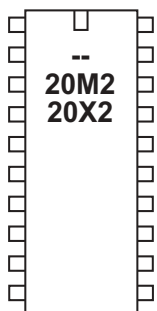
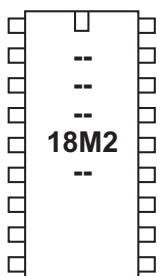
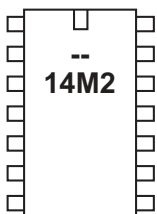
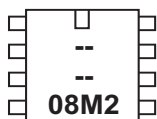

hsersetup

Syntax:

HSERSETUP OFF

HSERSETUP baud_setup, mode

- Baud_setup is a variable/constant which specifies the baud rate:

B300_X	where X =
B600_X	4 for 4MHz
B1200_X	8 for 8 MHz
B2400_X	16 for 16MHz
B4800_X	20 for 20MHZ
B9600_X	32 for 32MHx
B19200_X	40 for 40 MHz
B31250_X	64 for 64MHz
B38400_X	
B57600_X	
B115200_X	

- Mode is a variable/constant whose bits specify special functions (not all features are supported on all chips) :

bit0 - background receive serial data to the scratchpad (*not M2 parts*)

bit1 - invert serial output data (0 = "T", 1 = "N")

bit 2 - invert serial input data (0 = "T", 1 = "N")

bit 3 - disable hserout (1 = hserout pin normal i/o)

bit 4 - disable hserin (1 = hserin pin normal i/o)

Function:

Configure the hardware serial port for serial operation.

Information:

The hsersetup command is used to configure the fixed hardware serial port of the microcontroller. It configures two pins to be dedicated to hserin and hserout.

Both pins are affected, you cannot use just one pin for input or output.

The baud rate is configured by the baud_setup value. This is a number that sets the baud rate. For convenience a number of predefined values are predefined (e.g. B9600_4 for baud rate of 9600,n,8,1 at 4MHz operation). However other baud rates can also be calculated by the formula provided later in this section.

Hardware serial input can be configured in two ways:

1) via hserin command only (mode bit0 = 0)

2) automatic in the background (mode bit0 = 1) (not M2 parts)

In automatic background mode the hardware serial input is fully automated.

Serial data received by the hardware pin is saved into the scratchpad memory area as soon as it is received. Upon the hsersetup command the serial pointer (hserptr) is reset to 0. When a byte is received it is saved to this scratchpad address, the hserptr variable is incremented and the hserinflag flag is set (must be cleared by user software). Therefore the value 'hserptr -1' indicates the last byte written, and 'hserinflag = 1' indicates a byte has been received (see also the setintflg command). The scratchpad is a circular buffer that overflows without warning.

Polarity:

When bit1 is 0, the serial output polarity is 'True' which is same as a 'Txxx' baud rate in the 'serout' command. In this state the pin idles high and pulses low. This is the state normally used with a MAX232 type inverter for computer connection.

When bit1 is 1, the serial output polarity is 'Inverted' which is same as a 'Nxxx' baud rate in the 'serout' command. In this state the pin idles low and pulses high. This is the state normally used with third part devices (e.g. an AXE033 serial LCD) or director 'resistor' connection to a PC.

On some parts the hardware serial input polarity is always true, it cannot be inverted (ie bit 2 serial input inversion only applies to X2 parts). This is a limitation of the internal microcontroller structure. Therefore a MAX232 type inverter is required for computer connections.

Example:

```

hserssetup B9600_4, %10 ; 9600 baud, inverted TXD
main:
  for b0 = 0 to 63 ; start a loop
    read b0,b1 ; read value into b1
    hserout 0,(b1) ; transmit value to serial LCD
  next b0 ; next loop

```

Advanced Technical Information:

Users may choose to create their own 'baud_setup' setting for a specific desired baud rate. 'baud_setup' must be a word value, and can be calculated from the following equation (where 'n' is the baud_setup value):

$$\text{Desired baud rate} = F_{\text{osc}} / (4 (n + 1))$$

$$\text{So } n = ((F_{\text{osc}} / \text{baud rate}) / 4) - 1$$

So if Fosc (resonator frequency) is 4MHz, and a desired baud rate of 10400

$$n = ((4\,000\,000 / 10400) / 4) - 1 = 95 \text{ (rounded)}$$

Working the other way around to check the calculation, the exact actual baud rate at baud_setup value of 95 will be

$$\text{Baud rate} = 4\,000\,000 / (4 (95+1)) = 10416, \text{ which is close enough for most systems!}$$

Therefore the command uses 95 as the baud_value for baud rate 10400 at 4MHz.

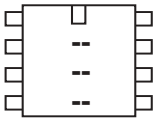

hspiin (hshin)

Syntax:

HSPIN (variable, {,variable,...})

- Variable receives the data.

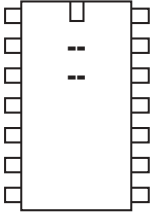

Function:

The hspiin (hshin also accepted by the compiler) command shifts in a data byte using the SPI hardware pins.

Description:

This command receives SPI data via the microcontroller's SPI hardware pins. This method is faster and more code efficient than using the 'bit-banged' spiin command.

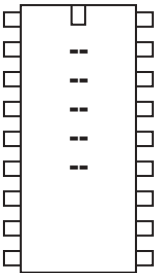

When connecting SPI devices (e.g. EEPROM) remember that the data-in of the EEPROM connects to the data-out of the PICAXE, and vice versa.

Note that a hspisepup command must be issued before this command will function.

Example:

See the hspisepup command for a detailed example.

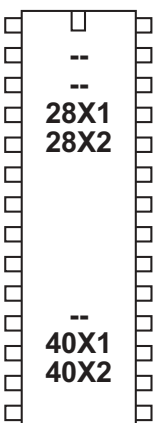
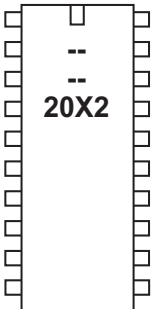

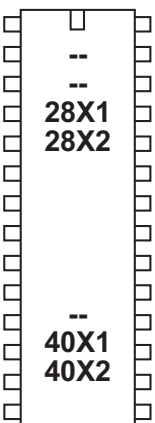
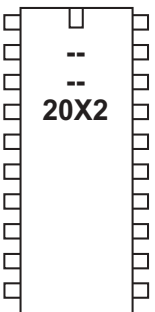
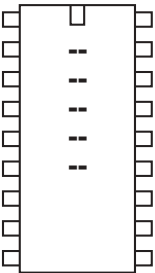
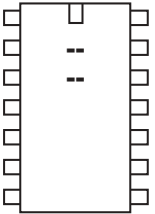
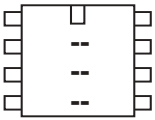

hspiout (hshout)

Syntax:

HSPI OUT (data, {,data,...})

- Data is a constant/variable of the byte data to output

Function:

The hspiout (hshout also accepted by the compiler) command shifts out data byte using the SPI hardware pins.

Description:

This command transmits SPI data via the microcontroller's SPI hardware pins. This method is faster and more code efficient than using the 'bit-banged' spiout command.

When connecting SPI devices (e.g. EEPROM) remember that the data-in of the EEPROM connects to the data-out of the PICAXE, and vice versa.

Note that a hspissetup command must be issued before this command will function.

Due to the internal operation of the microcontrollers SPI port, a hspiout command will only function when the hspiin 'input pin' is in the expected default state. If this pin is incorrect (e.g. high when it should be low), the hspiout byte cannot be sent (as the microcontroller automatically detects an SPI error condition). After 2.3 seconds of fault condition the PICAXE microcontroller will automatically reset.

Example:

See the hspissetup command for a detailed example.

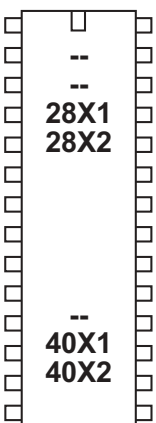
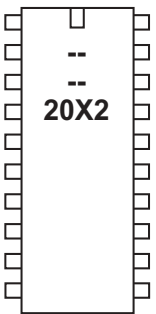
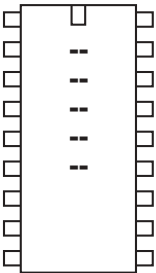
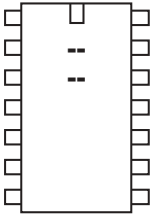
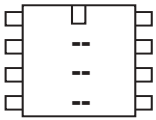

hspissetup

Syntax:

HSPI SETUP OFF

HSPI SETUP mode, spispeed

- Mode is a constant/variable to define the mode
 - spimode00 (mode 0,0 - input sampled at middle of data time)
 - spimode01 (mode 0,1 - input sampled at middle of data time)
 - spimode10 (mode 1,0 - input sampled at middle of data time)
 - spimode11 (mode 1,1 - input sampled at middle of data time)
 - spimode00e (mode 0,0 - input sampled at end of data time)
 - spimode01e (mode 0,1 - input sampled at end of data time)
 - spimode10e (mode 1,0 - input sampled at end of data time)
 - spimode11e (mode 1,1 - input sampled at end of data time)
- Spispeed is a constant/variable to define the clock speed
 - spifast (clock freq / 4) (= 1MHz with 4MHz resonator)
 - spimedium (clock freq / 16) (= 250kHz with 4MHz resonator)
 - spislow (clock freq / 64) (= 63 kHz with 4MHz resonator)

Function:

The hspissetup command sets the microcontroller's hardware pins to SPI mode.

Description:

This command setups the microcontroller for SPI transmission via the microcontroller's SPI hardware pins. This method is faster and more code efficient than using the 'bit-banged' spiout (shiftout) command.

When connecting SPI devices (e.g. EEPROM) remember that the data-in (SDI) of the EEPROM connects to the data-out (SDO) of the PICAXE, and vice versa.

Advanced Technical Information:

Users familiar with assembler code programming may find the following microcontroller information useful (see Logic Analyser screenshots overleaf).

spimode00	(CKP=0, CKE=1, SMP=0)	Mode (0,0)
spimode01	(CKP=0, CKE=0, SMP=0)	Mode (0,1)
spimode10	(CKP=1, CKE=1, SMP=0)	Mode (1,0)
spimode11	(CKP=1, CKE=0, SMP=0)	Mode (1,1)
spimode00e	(CKP=0, CKE=1, SMP=1)	
spimode01e	(CKP=0, CKE=0, SMP=1)	
spimode10e	(CKP=1, CKE=1, SMP=1)	
spimode11e	(CKP=1, CKE=0, SMP=1)	

Example:

This example shows how to read and write to a 25LC160 EEPROM.

Pin connection of the EEPROM is as follows:

1 - CS	picaxe output 7 (B.7)
2 - SO	picaxe input 4 (C.4)
3 - WP	+5V
4 - Vss	0V
5 - SI	picaxe input 5 (C.5)
6 - SCK	picaxe input 3 (C.3)
7 - HOLD	+5V
8 - Vdd	+5V

```
init:
    hspissetup spimodelle, spimedium    ; spi mode 1,1

    low cs                               ; enable chip select
    hspiout (6)                           ; send write enable
    high cs                               ; disable chip select

    low cs                               ; enable chip select
    hspiout (1,0)                         ; remove block protection
    high cs                               ; disable chip select
    pause 5                               ; wait write time

main:
    low cs                               ; enable chip select
    hspiout (6)                           ; send write enable
    high cs                               ; disable chip select

    low cs                               ; enable chip select
    hspiout (2,0,5,25)                   ; write 25 to address 5
    high cs                               ; disable chip select
    pause 5                               ; wait write time of 5ms

    low cs                               ; enable chip select
    hspiout (6)                           ; send write enable
    high cs                               ; disable chip select

    low cs                               ; enable chip select
    hspiout (3,0,5)                       ; send read command, address 5
    hspiin (b1)                           ; shift in the data
    high cs                               ; disable chip select

    low cs                               ; enable chip select
    hspiout (4)                           ; send write disable
    high cs                               ; disable chip select

    debug
    pause 1000
    goto main
```

hspiout - mode00

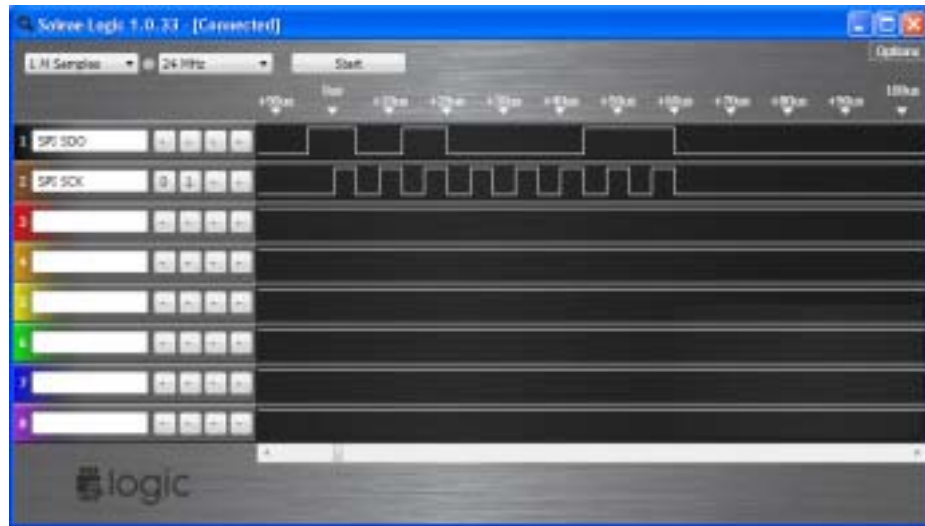

hspiout - mode01

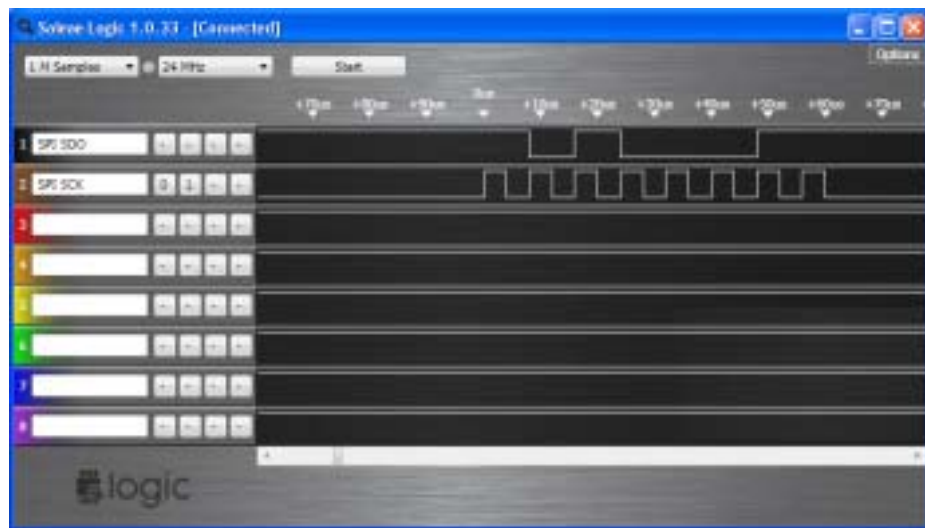

hspiout - mode10

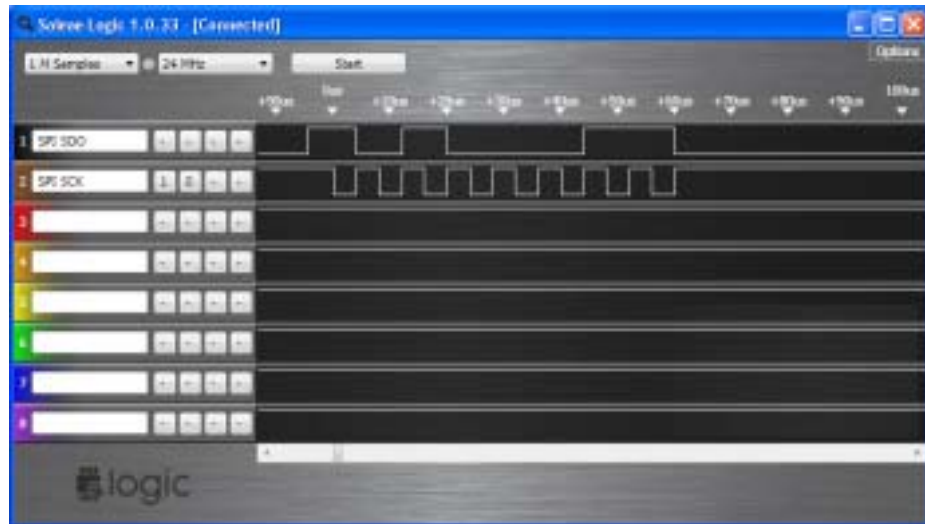

hspiout - mode11

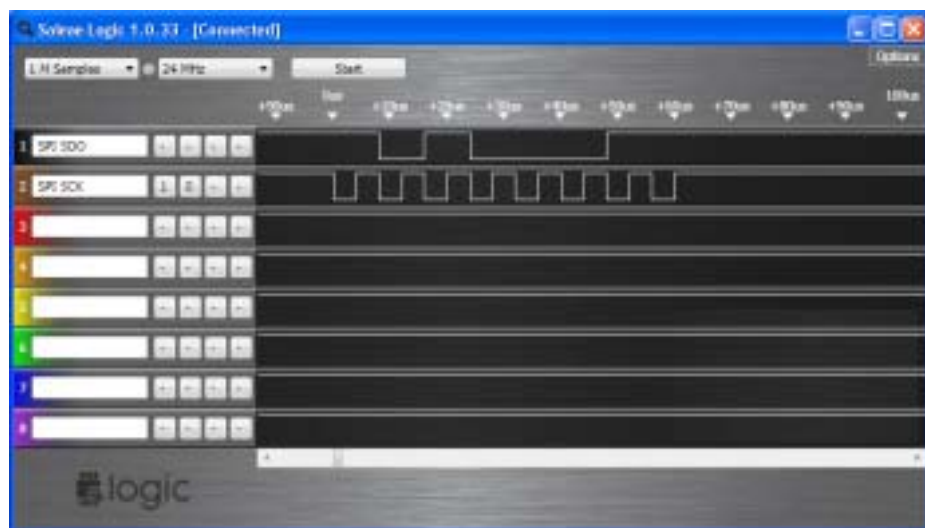

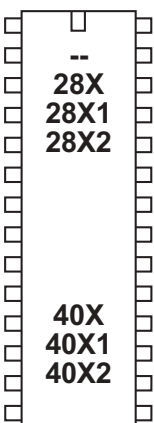
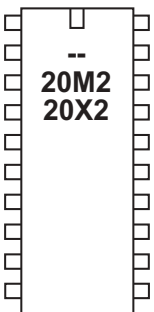
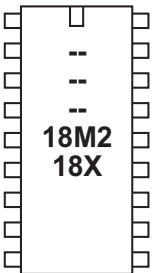
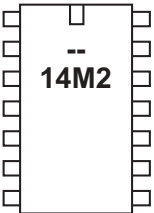
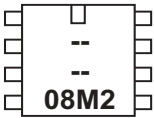

i2cslave

This command is deprecated, please consider using the hi2csetup command instead.

Syntax:

I2CSLAVE slaveaddress, mode, addresslen

- SlaveAddress is the i2c slave address
- Mode is the keyword i2cfast (400kHz) or i2cslow (100kHz) at 4Mhz
- Addresslen is the keyword i2cbyte or i2cword

Function:

The i2cslave command (slavei2c also accepted by the compiler) is used to configure the PICAXE pins for i2c use (in MASTER mode) and to define the type of i2c device to be addressed.

Description:

Use of i2c parts is covered in more detail in the separate 'i2c Tutorial' datasheet.

If you are using a single i2c device you generally only need one i2cslave command within a program. With the PICAXE-18X device you should issue the command at the start of the program to configure the SDA and SCL pins as inputs to conserve power.

After the i2cslave has been issued, readi2c and writei2c can be used to access the i2c device.

Slave Address

The slave address varies for different i2c devices (see table below). For the popular 24LCxx series serial EEPROMs the address is commonly %1010xxxx.

Note that some devices, e.g. 24LC16B, incorporate the block address (ie the memory page) into bits 1-3 of the slave address. Other devices include the external device select pins into these bits. In this case care must be made to ensure the hardware is configured correctly for the slave address used.

Bit 0 of the slave address is always the read/write bit. However the value entered using the i2cslave command is ignored by the PICAXE, as it is overwritten as appropriate when the slave address is used within the readi2c and writei2c commands.

Mode

Speed mode of the i2c bus can be selected by using one of the two keywords i2cfast or i2cslow (400kHz or 100kHz). The internal slew rate control of the microcontroller is automatically enabled at the 400kHz speed (28X/40X). Note that the 18X internal architecture means that the slower speed is always used with the 18X, as it is not capable of processing at the faster speed.

Effect of Increased Clock Speed:

Ensure you modify the speed keyword (i2cfast_8, i2cslow_8) at 8MHz or (i2cfast_16, i2cslow_16) at 16MHz for correct operation.

Address Length

i2c devices commonly have a single byte (i2cbyte) or double byte (i2cword) address. This must be correctly defined for the type of i2c device being used. If you use the wrong definition erratic behaviour will be experienced. When using the i2cword address length you must also ensure the 'address' used in the readi2c and writei2c commands is a word variable.

Note this is the EEPROM address length only, not the data bytes themselves. It is not possible to transmit a word value directly over i2c (e.g. word w0 must be transmitted as the two separate bytes b0 and b1)

Settings for some common parts:

Device	Type	Slave	Speed	Mode
24LC01B	EE 128	%1010xxxx	i2cfast	i2cbyte
24LC02B	EE 256	%1010xxxx	i2cfast	i2cbyte
24LC04B	EE 512	%1010xxbx	i2cfast	i2cbyte
24LC08B	EE 1kb	%1010xbbx	i2cfast	i2cbyte
24LC16B	EE 2kb	%1010bbbx	i2cfast	i2cbyte
24LC64	EE 8kb	%1010dddx	i2cfast	i2cword
24LC128	EE 16kb	%1010dddx	i2cfast	i2cword
24LC256	EE 32kb	%1010dddx	i2cfast	i2cword
24LC512	EE 64kb	%1010dddx	i2cfast	i2cword
DS1307	RTC	%1101000x	i2cslow	i2cbyte
MAX6953	5x7 LED	%101dddx	i2cfast	i2cbyte
AD5245	Digital Pot	%010110dx	i2cfast	i2cbyte
SRF08	Sonar	%1110000x	i2cfast	i2cbyte
AXE033	I2C LCD	\$C6	i2cslow	i2cbyte
CMPS03	Compass	%1100000x	i2cfast	i2cbyte
SPE030	Speech	%1100010x	i2cfast	i2cbyte

x = don't care (ignored)
 b = block select (selects internal memory page within device)
 d = device select (selects device via external address pin polarity)

See readi2c or writei2c for example program for DS1307 real time clock.

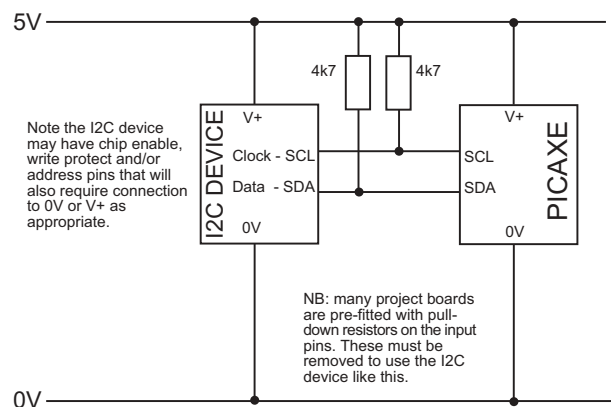

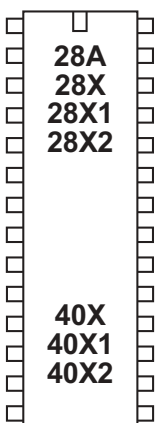
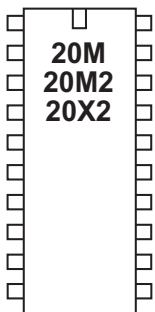
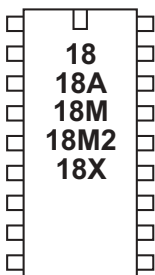
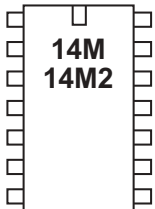
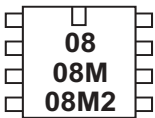

if...then \ elseif...then \ else \ endif

Syntax:

```
IF variable ?? value {AND/OR variable ?? value ...} THEN
{code}
ELSEIF variable ?? value {AND/OR variable ?? value ...} THEN
{code}
ELSE
{code}
ENDIF
```

Additional option on X1/X2 parts only :

```
IF variable BIT value SET THEN
{code}
ELSEIF variable BIT value CLEAR THEN
{code}
ELSE
{code}
ENDIF
```

- Variable(s) will be compared to value(s).
- Value is a variable/constant.
- Bit is the bit number to check if set (1) or clear (0)

?? can be any of the following conditions

```
= equal to
is equal to
<> not equal to
!= not equal to
> greater than
>= greater than or equal to
< less than
<= less than or equal to
```

Function:

Compare and conditionally execute sections of code.

Information:

The multiple line if...then\ elseif\ else \ endif command is used to test input pin variables (or general variables) for certain conditions. If these conditions are met that section of the program code is executed, and then program flow jumps to the endif position. If the condition is not met program flows jumps directly to the next elseif or else command.

The 'else' section of code is only executed if none of the if or elseif conditions have been true.

When using inputs the input variable (pin1, pin2 etc) must be used (not the actual pin name 1, 2 etc.) i.e. the line must read 'if pin1 = 1 then ...', not 'if 1 = 1 then ...'.

Note that

```

if b0 > 1 then (goto) label           ;(single line structure)
if b0 > 1 then gosub label           ;(single line structure)
if b0 > 1 then...else...endif       ;(multi line structure)

```

are 3 completely separate structures which cannot be combined. Therefore the following line is invalid as it tries to combine both a single and multi-line structure

```

if b0 > 1 then goto label else goto label2

```

This is invalid as the compiler does not know which structure you are trying to use ie:

```

if b0 > 1 then goto label : else : goto label2

```

or

```

if b0 > 1 then : goto label : else : goto label2

```

To achieve this structure the line must be re-written as

```

if b0 > 1 then
    goto label
else
    goto label2
endif

```

or

```

if b0 > 1 then : goto label : else : goto label2 : endif

```

The : character separates the sections into correct syntax for the compiler.

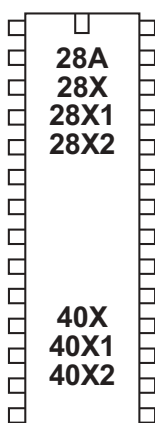
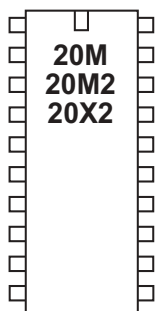
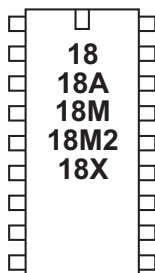
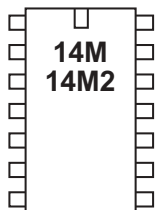
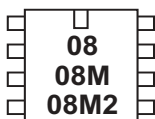
**if...then {goto}****if...and/ or..then {goto}***Syntax:***IF variable ?? value {AND/ OR variable ?? value ...} THEN address****IF variable BIT value SET/ CLEAR THEN address (X1/X2 parts only)**

- Variable(s) will be compared to value(s).
- Value is a variable/constant.
- Address is a label which specifies where to go if condition is true.

The keyword goto after then is optional.

?? can be any of the following conditions

- = equal to
- is equal to
- <> not equal to
- != not equal to
- > greater than
- >= greater than or equal to
- < less than
- <= less than or equal to

Function:

Compare and conditionally jump to a new program position.

Information:

The if...then command is used to test input pin variables (or general variables) for certain conditions. If these conditions are met program flow jumps to the new label. If the condition is not met the command is ignored and program flow continues on the next line.

When using inputs the input variable (pin1, pinC.2 etc) must be used (not the actual pin name 1, 2 etc.) i.e. the line must read 'if pinC.2 = 1 then ...', not 'if 2 = 1 then ...'. The if...then command only checks an input at the time the command is processed. Therefore it is normal to put the if...then command within a program loop that regularly scans the input. For details on how to permanently scan for an input condition using interrupts see the 'setint' command.

Examples:

Checking an input within a loop.

```

main:
    if pinC.0 = 1 then
        goto flsh ; jump to flsh if pin0 is high
    end if
    goto main ; else loop back to start

flsh: high B.1 ; switch on output B.1
    pause 5000 ; wait 5 seconds
    low B.1 ; switch off output B.1
    goto main ; loop back to start

```

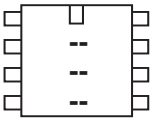

if porta...then {goto}

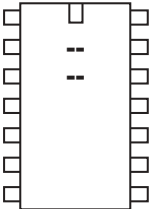

if portc...then {goto}

Syntax:

IF PORTA pin ?? value { AND/ OR variable ?? value ...} THEN address

IF PORTC pin ?? value { AND/ OR variable ?? value ...} THEN address

- Pin is the porta / portc pin to be tested

- Value is a variable/constant.

- Address is a label which specifies where to go if condition is true.

The keyword goto after then is optional.

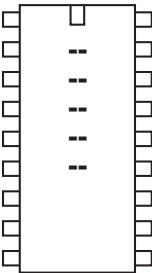

?? can be any of the following conditions

= equal to

is equal to

<> not equal to

!= not equal to

> greater than

>= greater than or equal to

< less than

<= less than or equal to

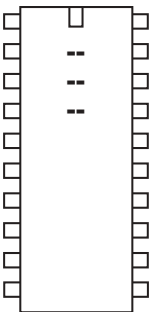

Function:

Compare and conditionally jump to a new program position.

Information:

This command is only used with the older 28X/X1 parts. For newer parts use the direct PORT.PIN notation instead e.g. if pinC.1 = 1 then...

Some PICAXE parts have additional inputs on porta and portc. In this case the PORTA or PORTC keyword is inserted after IF to redirect the whole line to the desired port. It is possible to use AND and OR within the command, but all pins tested will be on the same port, it is not possible to mix ports within one line.

The if...then command only checks an input at the time the command is processed. Therefore it is normal to put the if...then command within a program loop that regularly scans the input. For details on how to permanently scan for an input condition using interrupts see the 'setint' command.

Examples:

Checking a porta input within a loop.

main:

```
if porta pin0 = 1 then flsh ; jump to flsh if pin0 is high
goto main ; else loop back to start
```

```
flsh: high 1 ; switch on output 1
pause 5000 ; wait 5 seconds
low 1 ; switch off output 1
goto main ; loop back to start
```

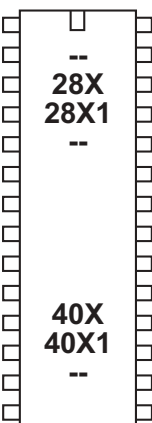

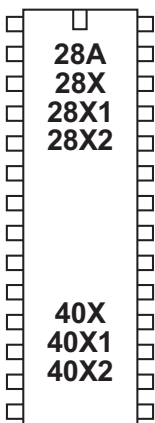
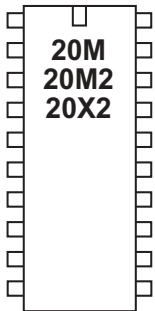
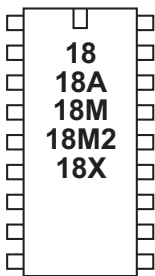
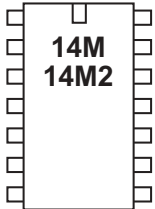
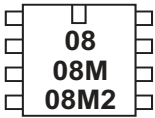
**if...then exit****if...and/ or...then exit***Syntax:*

IF variable ?? value {AND/ OR variable ?? value ...} THEN EXIT
IF variable BIT value SET/ CLEAR THEN EXIT (X1/ X2 parts only)

- Variable(s) will be compared to value(s).
- Value is a variable/constant.

?? can be any of the following conditions

- = equal to
- is equal to
- <> not equal to
- != not equal to
- > greater than
- >= greater than or equal to
- < less than
- <= less than or equal to

Function:

Compare and conditionally exit a do...loop or for...next loop

Information:

The if...then exit command is used to test input pin variables (or general variables) for certain conditions. If these conditions are met the current loop (do...loop or for...next) is prematurely ended.

Multiple compares can be combined with the AND and OR keywords. For examples on how to use AND and OR see the if...then goto command.

Example:

Checking an input within a do loop.

```
do
  if pinC.0 = 1 then exit      ; exit if pinC.0 is high
loop
```

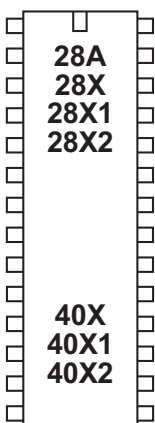
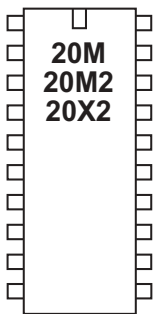
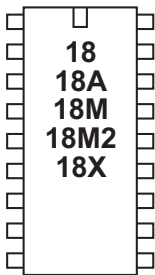
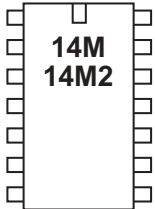
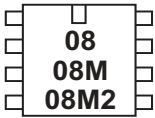

if...then gosub

if...and/ or...then gosub

Syntax:

IF variable ?? value {AND/ OR variable ?? value ...} THEN GOSUB address

IF variable BIT value SET/ CLEAR THEN GOSUB address (X1/X2 parts only)

- Variable(s) will be compared to value(s).
- Value is a variable/constant.
- Address is a label which specifies where to gosub if condition is true.

?? can be any of the following conditions

- = equal to
- is equal to
- <> not equal to
- != not equal to
- > greater than
- >= greater than or equal to
- < less than
- <= less than or equal to

Function:

Compare and conditionally execute a gosub command.

Information:

The if...then gosub command is used to test input pin variables (or general variables) for certain conditions. If these conditions are met a sub procedure is executed. If the condition is not met the command is ignored and program flow continues on the next line. Any executed sub procedure returns to the next line.

When using inputs the input variable (pin1, pin2 etc) must be used (not the actual pin name 1, 2 etc.) i.e. the line must read 'if pin1 = 1 then gosub...', not 'if 1 = 1 then gosub...'

The if...then gousb command only checks an input at the time the command is processed. Therefore it is normal to put the if...then command within a program loop that regularly scans the input.

Multiple compares can be combined with the AND and OR keywords. For examples on how to use AND and OR see the if...then goto command.

Example:

Checking an input within a loop.

```
main:
  if pinC.0 = 1 then gosub flsh      ; sub to flsh if pin0 is high
  goto main                          ; else loop back to start

flsh: high B.1                        ; switch on output B.1
  pause 5000                          ; wait 5 seconds
  low B.1                              ; switch off output B.1
  return
```

2 input AND gate

```
if pinC.1 = 1 and pinC.2 = 1 then gosub label
```

3 input AND gate

```
if pinC.0 = 1 and pinC.1 = 1 and pinC.2 = 1 then gosub label
```

2 input OR gate

```
if pinC.1 = 1 or pinC.2 = 1 then gosub label
```

analogue value between certain values

```
readadc 1,b1
```

```
if b1 >= 100 and b1 <= 200 then gosub label
```

To read the whole input port at once the variable 'pins' can be used

```
if pins = %10101010 then gosub label
```

To read the whole input port and mask individual inputs (e.g. 6 and 7)

```
let b1 = pins & %11000000
```

```
if b1 = %11000000 then gosub label
```

The words is (=), on (1) and off (0) can also be used with younger students.

loop1:

```
if pin0 is on then gosub flsh ; flsh if pin0 is high
goto loop1 ; else loop back to start
```

```
flsh: high B.1 ; switch on output B.1
pause 5000 ; wait 5 seconds
low B.1 ; switch off output B.1
return ; return
```

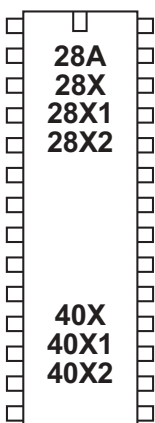
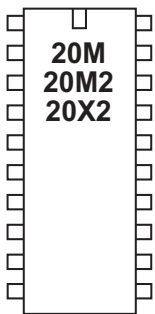
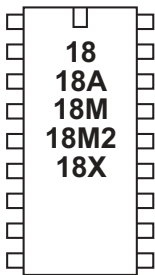
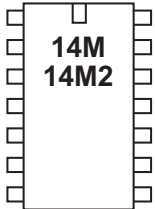
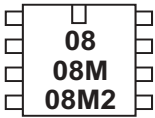
**inc***Syntax:***INC**var

- var is the variable to increment

Function:

Increment (add 1 to) the variable value.

Information:

This command is shorthand for 'let var = var + 1'

Example:

```

for b1 = 1 to 5
  inc b2
next b1

```

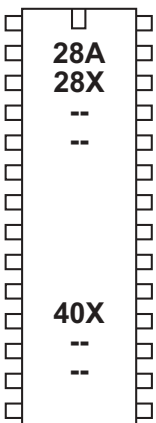
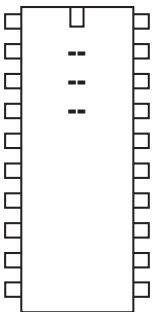
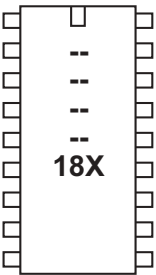
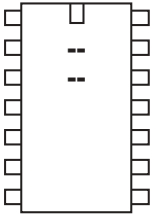
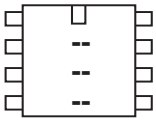

infrain

This command is deprecated, please consider using the irin command instead.

Syntax:

INFRAIN

Function:

Wait until a new infrared command is received.

Description:

This command is primarily used to wait for a new infrared signal from the infrared TV style transmitter. It can also be used with an infraout signal from a separate PICAXE chip. All processing stops until the new command is received. The value of the command received is placed in the predefined variable 'infra'.

The infra-red input is input 0 on all parts that support this command. See also infrain2. The variable 'infra' is separate from the other variables.

After using this command you may have to perform a 'hard reset' to download a new program to the microcontroller. See the Serial Download section for more details.

Effect of Increased Clock Speed:

This command will only function at 4MHz

Use of TVR010 Infrared Remote Control:

The table shows the value that will be placed into the variable 'infra' depending on which key is pressed on the transmitter.

Before use (or after changing batteries) the TVR010 transmitter must be programmed with 'Sony' codes as follows:

1. Insert 3 AAA size batteries, preferably alkaline.
2. Press 'C': The LED should light.
3. Press '2': The LED should flash.
4. Press '1': The LED should flash.
5. Press '2': The LED should flash and then go out.

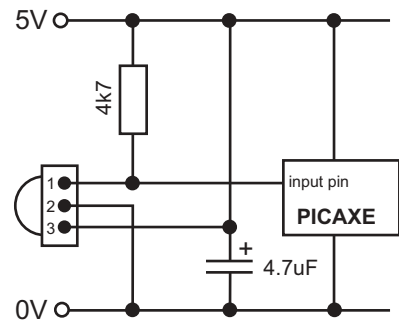
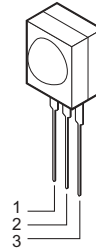

byte

Key	Value
1	1
2	2
3	3
4	4
5	5
6	6
7	7
8	8
9	9
P+	10
0	11
V+	12
P-	13
10+	14
V-	15
Mute	16
Power	17



Example:

```

main:
  infrain                                ;wait for new signal
  if infra = 1 then swon1                ;switch on 1
  if infra = 2 then swon2                ;switch on 2
  if infra = 3 then swon3                ;switch on 3
  if infra = 4 then swoff1               ;switch off 1
  if infra = 5 then swoff2               ;switch off 2
  if infra = 6 then swoff3               ;switch off 3
  goto main

```

```

swon1:      high 1
            goto main
swon2:      high 2
            goto main
swon3:      high 3
            goto main
swoff1:     low 1
            goto main
swoff2:     low 2
            goto main
swoff3:     low 3
            goto main

```

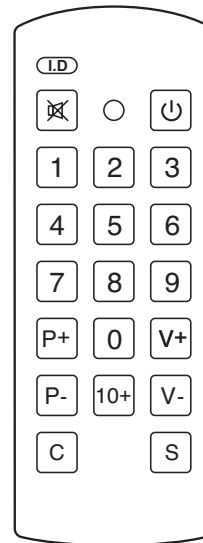

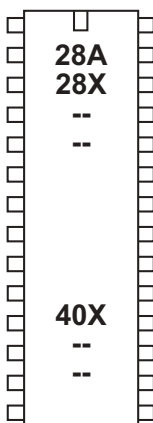
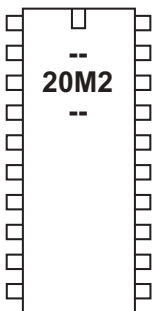
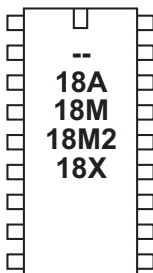
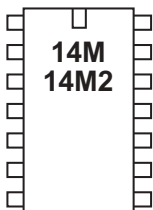
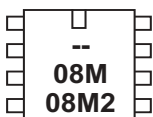

infrain2

This command is deprecated, please consider using the irin command instead.

Syntax:
INFRAIN2

Function:
Wait until a new infrared command is received.

Description:
This command is used to wait for an infraout signal from a separate PICAXE chip. It can also be used with an infrared signal from the infrared TV style transmitter (i.e. can replace infrain). All processing stops until the new command is received. The value of the command received is placed in the predefined variable 'infra'. This will be a number between 0 and 127. See the infraout command description for more details about the values that will be received from the TVR010 remote control.

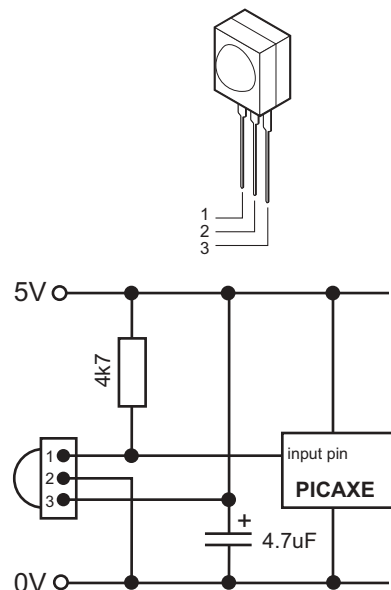

On the PICAXE-08M/14M/20M 'infra' is another name for 'b13' - it is the same variable. The infra-red input is fixed to a single input - see the PICAXE pinout diagrams. On M2 parts the compiler outputs an irin command using b13.

After using this command you may have to perform a 'hard reset' to download a new program to the microcontroller. See the Serial Download section for more details.

Effect of Increased Clock Speed:

This command will only function at 4MHz. Use a setfreq m4 command before this command if using 8MHz speed,

Example:

```

main:
    infrain2                ; wait for new signal
    if infra = 1 then swon1  ; switch on 1
    if infra = 4 then swoff1 ; switch off 1
    goto main

swon1:    high 1
          goto main

swoff1:   low 1
          goto main
    
```

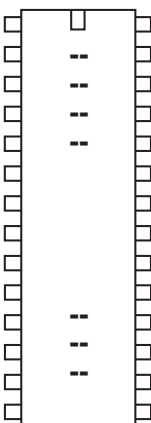
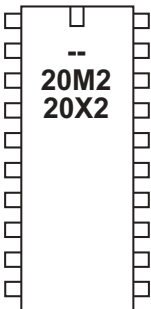
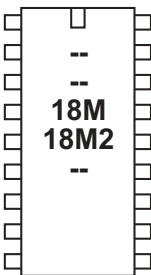
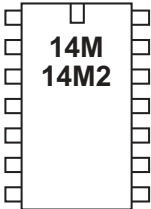
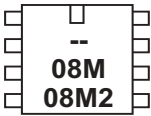

infraout

This command is deprecated, please consider using the irout command instead.

Syntax:

INFRAOUT device,data

- device is a constant/variable (valid device ID 1-31)
- data is a constant/variable (valid data 0-127)

Function:

Transmit an infra-red signal, modulated at 38kHz.

Description:

This command is used to transmit the infra-red data to Sony™ device (can also be used to transmit data to another PICAXE that is using the infrain or infrain2 command). Data is transmitted via an infra-red LED (connected on output 0) using the SIRC (Sony Infra Red Control) protocol.

- device - 5 bit device ID (0-31)
- data - 7 bit data (0-127)

When using this command to transmit data to another PICAXE the device ID used must be value 1 (TV). The infraout command can be used to transmit any of the valid TV command 0-127. Note that the Sony protocol only uses 7 bits for data, and so data of value 128 to 255 is not valid.

Therefore the valid infraout command for use with infrain2 is

infraout 1,x ;(where x = 0 to 127)

Start	Data0	Data1	Data2	Data3	Data4	Data5	Data6	ID0	ID1	ID2	ID3	ID4
2.4ms	1.2 or 0.6ms	1.2 or 0.6ms	1.2 or 0.6ms	1.2 or 0.6ms	1.2 or 0.6ms	1.2 or 0.6ms	1.2 or 0.6ms	1.2 or 0.6ms	1.2 or 0.6ms	1.2 or 0.6ms	1.2 or 0.6ms	1.2 or 0.6ms

Sony SIRC protocol:

The SIRC protocol uses a 38KHz modulated infra-red signal consisting of a start bit (2.4ms) followed by 12 data bits (7 data bits and 5 device ID bits). Logic level 1 is transmitted as a 1.2 ms pulse, logic 0 as a 0.6ms pulse. Each bit is separated by a 0.6ms silence period.

Example:

All commercial remote controls repeat the signal every 45ms whilst the button is held down. Therefore when using the PICAXE system higher reliability may be gained by repeating the transmission (e.g. 10 times) within a for..next loop.

```
for b1 = 1 to 10
  infraout 1,5
  pause 45
next b1
```

Interaction between infrain, infrain2 and infraout command.

Infrain and Infraout

The original infrain command was designed to react to signals from the TV style remote control TVR010. Therefore it only acknowledges the data sent from the 17 buttons on this remote (1-9, 0, 10+, P+, P-, V+, V-, MUTE, PWR) with a value between 1 and 17.

The infraout command can be used to 'emulate' the TVR010 remote to transmit signals that will be acceptable for the infrain command. The values to be used for each TV remote button are shown in the table.

TVR010 TV Remote Control	infraout / irout command	infrain variable data value	infrain2, Irin variable data value
1	infraout 1,0	1	0
2	infraout 1,1	2	1
3	infraout 1,2	3	2
4	infraout 1,3	4	3
5	infraout 1,4	5	4
6	infraout 1,5	6	5
7	infraout 1,6	7	6
8	infraout 1,7	8	7
9	infraout 1,8	9	8
P+	infraout 1,16	10	16
0	infraout 1,9	11	9
V+	infraout 1,18	12	18
P-	infraout 1,17	13	17
10+	infraout 1,12	14	12
V-	infraout 1,19	15	19
MUTE	infraout 1,20	16	20
PWR	infraout 1,21	17	21

Infrain2 and Infraout

The infrain2 command will react to *any* of the valid TV data commands (0 to 127).

The infraout command can be used to transmit any of the valid TV command 0-127. Note that the Sony protocol only uses 7 bits for data, and so data of 128 to 255 is not valid.

Therefore the valid infraout command for use with infrain2 is (where x = 0 to 127)

infraout 1,x

Effect of Increased Clock Speed:

This command will only function at 4MHz.

Common Sony Device IDs.:

TV	1	VTR3	11
VTR1	2	Surround Sound	12
Text	3	Audio	16
Widescreen	4	CD Player	17
MDP / Laserdisk	6	Pro-Logic	18
VTR2	7	DVD	26

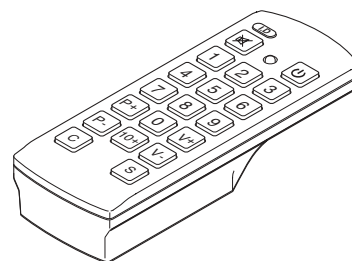

Button infraout data for a typical Sony TV (device ID 1)

000 1 button
001 2 button
002 3 button
003 4 button
004 5 button
005 6 button
006 7 button
007 8 button
008 9 button
009 10 button/0 button
011 Enter
016 channel up
017 channel down
018 volume up
019 volume down
020 Mute
021 Power
022 Reset TV
023 Audio Mode:Mono/SAP/Stereo
024 Picture up
025 Picture down
026 Color up
027 Color down
030 Brightness up
031 Brightness down
032 Hue up
033 Hue down
034 Sharpness up
035 Sharpness down
036 Select TV tuner
038 Balance Left
039 Balance Right
041 Surround on/off
042 Aux/Ant
047 Power off
048 Time display
054 Sleep Timer
058 Channel Display
059 Channel jump
064 Select Input Video1
065 Select Input Video2
066 Select Input Video3

Button infraout data for a typical Sony TV (continued...)

- 074 Noise Reduction on/off
- 078 Cable/Broadcast
- 079 Notch Filter on/off
- 088 PIP channel up
- 089 PIP channel down
- 091 PIP on
- 092 Freeze screen
- 094 PIP position
- 095 PIP swap
- 096 Guide
- 097 Video setup
- 098 Audio setup
- 099 Exit setup
- 107 Auto Program
- 112 Treble up
- 113 Treble down
- 114 Bass up
- 115 Bass down
- 116 + key
- 117 - key
- 120 Add channel
- 121 Delete channel
- 125 Trinitone on/off
- 127 Displays a red RtestS on the screen

Button infraout data for a typical Sony VCR (device ID 2 or 7)

000	1 button
001	2 button
002	3 button
003	4 button
004	5 button
005	6 button
006	7 button
007	8 button
008	9 button
009	10 button/0 button
010	11 button
011	12 button
012	13 button
013	14 button
020	X2 play w/sound
021	power
022	eject
023	L-CH/R-CH/Stereo
024	stop
025	pause
026	play
027	rewind
028	FF
029	record
032	pause engage
035	X 1/5 play
040	reverse visual scan
041	forward visual scan
042	TV/VIR
045	VIR from TV
047	power off
048	single frame reverse/slow reverse play
049	single frame advance/slow forward play
060	aux
070	counter reset
078	TV/VIR
083	index (scan)
106	edit play
107	mark

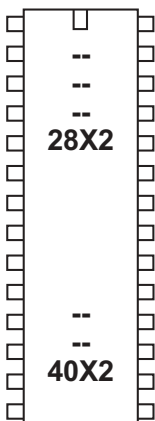
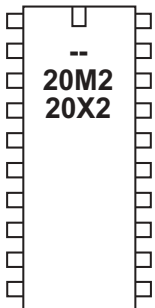
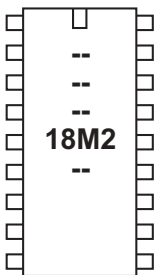
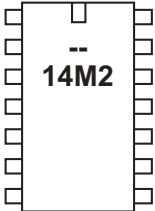
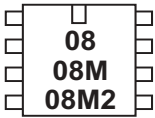

input

Syntax:

INPUT pin, pin, pin...

- Pin is a variable/constant which specifies the i/o pin to use.

Function:

Make pin an input.

Information:

This command is only required on microcontrollers with programmable input/output pins. This command can be used to change a pin that has been configured as an output back to an input.

All pins are configured as inputs on first power-up (unless the pin is a fixed output). Fixed pins are not affected by this command. These pins are:

08, 08M, 08M2	0 = fixed output	3 = fixed input
14M2	B.0 = fixed output	C.3 = fixed input
18M2	C.3 = fixed output	C.4, C.5 = fixed input
20M2, 20X2	A.0 = fixed output	C.6 = fixed input
28X2, 40X2	A.4 = fixed output	

Example:

main:

```
input B.1      ; make pin input
reverse B.1    ; make pin output
reverse B.1    ; make pin input
output B.1     ; make pin output
```

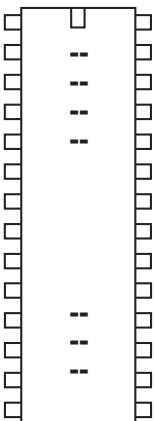
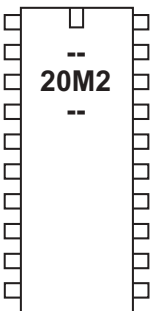
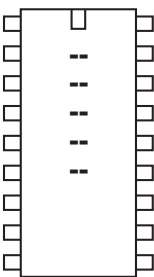
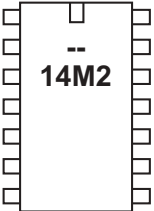
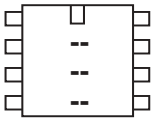
inputtype

Syntax:

INPUTTYPE mask

- Mask is a variable/constant which specifies the input pin type.

Function:

Make pin an input of hardware silicon type TTL (0) or ST (1).

Information:

Microcontroller inputs can be of two types, TTL compatible or ST (Schmitt Trigger). On most PICAXE chips this type is predefined by the internal silicon design and cannot be changed. Many chips contain a mixture of both types. See the tables overleaf for more details about the type of each PICAXE chip input.

However, with improvements in silicon technology, on the more recent M2 parts each input can be user configured to be either the TTL (0) or ST (1) type. Mask is a word length value where bits0-7 correspond to B.0 to B.7 and bits8-15 correspond to C.0 to C.7. Setting a bit to 1 makes it a ST type input, setting a bit to 0 makes it a TTL type (power up value is 0, TTL, on all pins).

The difference between TTL/ST input pin types is as follows:

Schmitt Trigger (ST)		<i>Examples:</i>	5V	3V
Status 'high' if	> 0.8 * Vsupply		>4V	>2.4V
Status 'low' if	< 0.2 * Vsupply		<1V	<0.6V
TTL (Supply voltage > 4.5V)				
Status 'high' if	> 2.0V		>2V	n/a
Status 'low' if	< 0.8V		<0.8V	n/a
TTL (Supply voltage < 4.5V)				
Status 'high' if	> 0.25 * Vsupply + 0.8V		n/a	>1.55V
Status 'low' if	< 0.15 * Vsupply		n/a	<0.45V

Values between these voltages are 'floating' and cannot be reliably used as either a high or low signal.

Therefore in general TTL inputs are considered more versatile, as, for instance, at a 5V supply they will be guaranteed a 'high' signal at above 2V instead of at above 4V. However on some occasions Schmitt Trigger inputs may be desired.

Example:

```
main:
inputtype %0000000000001111 ; make pin B.0 to B.3 ST
inputtype %0000111100000000 ; make pin C.0 to C.3 ST
```

Input Pin Types:

	08M2	08M	08
Serin	TTL	TTL	TTL
C.1	TTL	TTL	TTL
C.2	ST	ST	ST
C.3	TTL	TTL	TTL
C.4	TTL	TTL	TTL

	14M2*	14M
Serin	TTL	TTL
B.0	TTL	n/a
B.1	TTL	n/a
B.2	TTL	n/a
B.3	TTL	n/a
B.4	TTL	n/a
B.5	TTL	n/a
C.0	TTL	TTL
C.1	TTL	TTL
C.2	TTL	TTL
C.3	TTL	TTL
C.4	TTL	TTL

** 14M2 pins can be reconfigured via 'inputtype' command*

	18M2	18X	18M	18A	18
Serin	TTL	ST	ST	ST	ST
B.0	TTL	n/a	n/a	n/a	n/a
B.1	TTL	n/a	n/a	n/a	n/a
B.2	TTL	n/a	n/a	n/a	n/a
B.3	TTL	n/a	n/a	n/a	n/a
B.4	TTL	n/a	n/a	n/a	n/a
B.5	TTL	n/a	n/a	n/a	n/a
B.6	TTL	n/a	n/a	n/a	n/a
B.7	TTL	n/a	n/a	n/a	n/a
C.0	TTL	TTL	TTL	TTL	ST
C.1	TTL	TTL	TTL	TTL	ST
C.2	TTL	TTL	TTL	TTL	ST
C.5	TTL	n/a	n/a	n/a	n/a
C.6	TTL	ST	ST	ST	ST
C.7	TTL	ST	ST	ST	ST

	20X2	20M2*	20M
Serin	TTL	TTL	TTL
B.0	TTL	TTL	n/a
B.1	TTL	TTL	n/a
B.2	ST	TTL	n/a
B.3	ST	TTL	n/a
B.4	ST	TTL	n/a
B.5	TTL	TTL	n/a
B.6	TTL	TTL	n/a
B.7	TTL	TTL	n/a
C.0	TTL	TTL	TTL
C.1	ST	TTL	ST
C.2	ST	TTL	ST
C.3	ST	TTL	ST
C.4	ST	TTL	ST
C.5	ST	TTL	ST
C.6	TTL	TTL	TTL
C.7	TTL	TTL	TTL

* 20M2 pins can be reconfigured via 'inputtype' command

	28X2	28X2-5V	28X2-3V	28X1	28X	28A	28
Serin	ST	ST	ST	ST	ST	ST	ST
A.0	TTL	TTL	TTL	TTL	TTL	ADC	ADC
A.1	TTL	TTL	TTL	TTL	TTL	ADC	ADC
A.2	TTL	TTL	TTL	TTL	TTL	ADC	ADC
A.3	TTL	TTL	TTL	TTL	TTL	ADC	ADC
B.0	TTL	TTL	TTL	n/a	n/a	n/a	n/a
B.1	TTL	TTL	TTL	n/a	n/a	n/a	n/a
B.2	TTL	TTL	TTL	n/a	n/a	n/a	n/a
B.3	TTL	TTL	TTL	n/a	n/a	n/a	n/a
B.4	TTL	TTL	TTL	n/a	n/a	n/a	n/a
B.5	TTL	TTL	TTL	n/a	n/a	n/a	n/a
B.6	TTL	TTL	TTL	n/a	n/a	n/a	n/a
B.7	TTL	TTL	TTL	n/a	n/a	n/a	n/a
C.0	TTL	ST	ST	ST	ST	ST	ST
C.1	TTL	ST	ST	ST	ST	ST	ST
C.2	TTL	ST	ST	ST	ST	ST	ST
C.3	TTL	ST	ST	ST	ST	ST	ST
C.4	TTL	ST	ST	ST	ST	ST	ST
C.5	TTL	ST	ST	ST	ST	ST	ST
C.6	TTL	ST	ST	ST	ST	ST	ST
C.7	TTL	ST	ST	ST	ST	ST	ST

	40X2	40X2-5V	40X2-3V	40X1	40X
Serin	ST	ST	ST	ST	ST
A.0	TTL	TTL	TTL	TTL	TTL
A.1	TTL	TTL	TTL	TTL	TTL
A.2	TTL	TTL	TTL	TTL	TTL
A.3	TTL	TTL	TTL	TTL	TTL
A.5	TTL	ST	ST	ADC	ADC
A.6	TTL	ST	ST	ADC	ADC
A.7	TTL	ST	ST	ADC	ADC
B.0	TTL	TTL	TTL	n/a	n/a
B.1	TTL	TTL	TTL	n/a	n/a
B.2	TTL	TTL	TTL	n/a	n/a
B.3	TTL	TTL	TTL	n/a	n/a
B.4	TTL	TTL	TTL	n/a	n/a
B.5	TTL	TTL	TTL	n/a	n/a
B.6	TTL	TTL	TTL	n/a	n/a
B.7	TTL	TTL	TTL	n/a	n/a
C.0	TTL	ST	ST	ST	ST
C.1	TTL	ST	ST	ST	ST
C.2	TTL	ST	ST	ST	ST
C.3	TTL	ST	ST	ST	ST
C.4	TTL	ST	ST	ST	ST
C.5	TTL	ST	ST	ST	ST
C.6	TTL	ST	ST	ST	ST
C.7	TTL	ST	ST	ST	ST
D.0	TTL	TTL	TTL	TTL	TTL
D.1	TTL	TTL	TTL	TTL	TTL
D.2	TTL	TTL	TTL	TTL	TTL
D.3	TTL	TTL	TTL	TTL	TTL
D.4	TTL	TTL	TTL	TTL	TTL
D.5	TTL	TTL	TTL	TTL	TTL
D.6	TTL	TTL	TTL	TTL	TTL
D.7	TTL	TTL	TTL	TTL	TTL

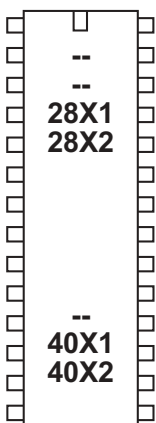
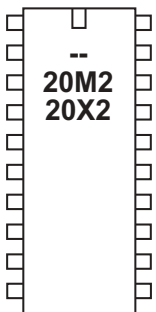
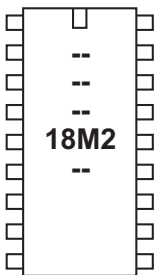
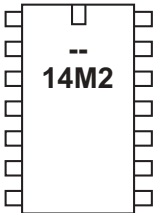
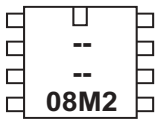

irin

Syntax:

- IRIN pin, variable**
- IRIN [timeout], pin, variable**
- IRIN [timeout, address], pin, variable**

- Timeout is a variable/constant which sets the timeout period in milliseconds
- Address is a label which specifies where to go if a timeout occurs.
- pin is a variable/constant which specifies the i/o pin to use.
- Variable receives the data

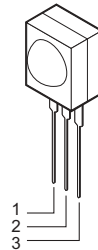

Function:

Wait until a new infrared command is received. This command is similar to the 'infrain2' command found on other PICAXE devices, but can be used on any input pin.

Description:

This command is used to wait for an infrared signal from a separate PICAXE chip. It can also be used with an infrared signal from the infrared TV style transmitter (i.e., can replace infrain). All processing stops until the new command is received, but after a timeout period program flow will jump to 'address'. The value of the command received is placed into the defined variable. This will be a number between 0 and 127. See the infrared command description for more details about the values that will be received from the TVR010 remote control.

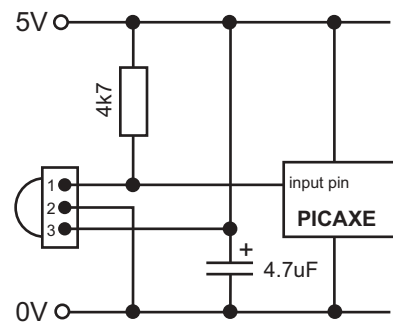

Start	Data0	Data1	Data2	Data3	Data4	Data5	Data6	ID0	ID1	ID2	ID3	ID4
2.4ms	1.2 or 0.6ms	1.2 or 0.6ms	1.2 or 0.6ms	1.2 or 0.6ms	1.2 or 0.6ms	1.2 or 0.6ms	1.2 or 0.6ms	1.2 or 0.6ms	1.2 or 0.6ms	1.2 or 0.6ms	1.2 or 0.6ms	1.2 or 0.6ms

To replace an infrain / infrain2 command with irin use these two lines:

```
symbol infra = b13 ; define an infra variable
irin C.0, infra ; read input C.0 into infra
```

Effect of Increased Clock Speed:

This command will automatically use the internal 4MHz resonator for correct operation.

Example:

```
main:
    irin [1000,main],C.3,b0 ;wait for new signal
    if b0 = 1 then swon1 ;switch on 1
    if b0 = 4 then swoff1 ;switch off 1
    goto main

swon1:    high B.1
          goto main

swoff1:  low B.1
          goto main
```

TVR010 TV Remote Control	irout command	infrain variable data value	infrain2, irin variable data value
1	irout pin,1,0	1	0
2	irout pin,1,1	2	1
3	irout pin,1,2	3	2
4	irout pin,1,3	4	3
5	irout pin,1,4	5	4
6	irout pin,1,5	6	5
7	irout pin,1,6	7	6
8	irout pin,1,7	8	7
9	irout pin,1,8	9	8
P+	irout pin,1,16	10	16
0	irout pin,1,9	11	9
V+	irout pin,1,18	12	18
P-	irout pin,1,17	13	17
10+	irout pin,1,12	14	12
V-	irout pin,1,19	15	19
MUTE	irout pin,1,20	16	20
PWR	irout pin,1,21	17	21

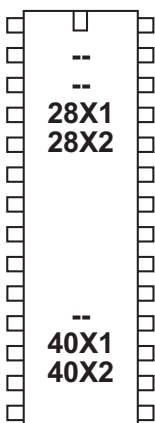
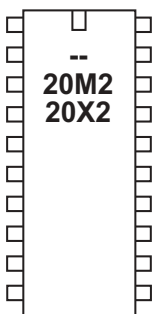
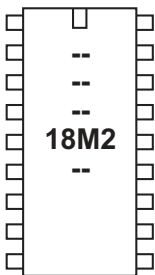
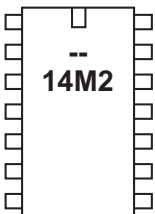
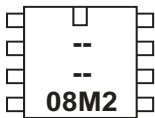

irout

Syntax:

IROUT pin,device,data

- pin is a variable/constant which specifies the i/o pin to use.
- device is a constant/variable (valid device ID 1-31)
- data is a constant/variable (valid data 0-127)

Function:

Transmit an infra-red signal, modulated at 38kHz.

This command is similar to the 'infraout' command found on earlier PICAXE devices, but can be used on any output pin.

Description:

This command is used to transmit the infra-red data to Sony™ device (can also be used to transmit data to another PICAXE that is using the irin, infrain or infrain2 command). Data is transmitted via an infra-red LED using the SIRC (Sony Infra Red Control) protocol.

device - 5 bit device ID (0-31)

data - 7 bit data (0-127)

When using this command to transmit data to another PICAXE the device ID used must be value 1 (TV). The irout command can be used to transmit any of the valid TV command 0-127. Note that the Sony protocol only uses 7 bits for data, and so data of value 128 to 255 is not valid.

Therefore the valid infraout command for use with infrain2/infrain/irin is

irout 1,1,x ; (where x = 0 to 127)

Sony SIRC protocol:

The SIRC protocol uses a 38KHz modulated infra-red signal consisting of a start bit (2.4ms) followed by 12 data bits (7 data bits and 5 device ID bits). Logic level 1 is transmitted as a 1.2 ms pulse, logic 0 as a 0.6ms pulse. Each bit is separated by a 0.6ms silence period. For more information about the protocol see the 'infraout' command description.

Effect of Increased Clock Speed:

This command will automatically use the internal 4MHz resonator for correct operation.

Example:

All commercial remote controls repeat the signal every 45ms whilst the button is held down. Therefore when using the PICAXE system higher reliability may be gained by repeating the transmission (e.g. 10 times) within a for..next loop.

for b1 = 1 to 10

irout 1,1,5

pause 45

next b1

TVR010 TV Remote Control	irout command	infrain variable data value	infrain2, irin variable data value
1	irout pin,1,0	1	0
2	irout pin,1,1	2	1
3	irout pin,1,2	3	2
4	irout pin,1,3	4	3
5	irout pin,1,4	5	4
6	irout pin,1,5	6	5
7	irout pin,1,6	7	6
8	irout pin,1,7	8	7
9	irout pin,1,8	9	8
P+	irout pin,1,16	10	16
0	irout pin,1,9	11	9
V+	irout pin,1,18	12	18
P-	irout pin,1,17	13	17
10+	irout pin,1,12	14	12
V-	irout pin,1,19	15	19
MUTE	irout pin,1,20	16	20
PWR	irout pin,1,21	17	21

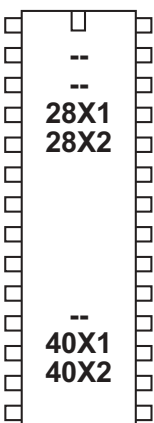
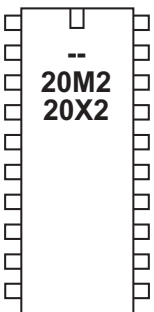
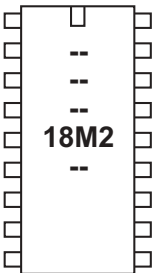
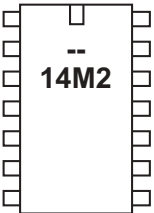
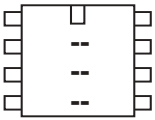

kb

Syntax:

KBIN variable

KBIN [timeout], variable

KBIN [timeout, address], variable

KBIN #variable

(M2 parts only)

KBIN [timeout], #variable

(M2 parts only)

KBIN [timeout, address], #variable

(M2 parts only)

- Variable receives the key
- Timeout is a variable/constant which sets the timeout period in milliseconds
- Address is a label which specifies where to go if a timeout occurs.

Function:

Wait until a new keyboard press is received. This command is similar to the keyin command found on older PICAXE parts, but also includes a timeout option.

Information:

This command is used to wait for a new key press from a computer keyboard (connected directly to the PICAXE - not the keyboard used whilst programming, see keyed command for connection details). All processing stops until the new key press is received, but program flow will jump to address after the timeout period. The value of the key press received is placed in the variable.

Note the design of the keyboard means that the value of each key is not logical, each key value must be identified from the table (see table on next page). Some keys use two numbers, the first \$E0 is ignored by the PICAXE and so keyvalue will return the second number. Note all the codes are in hex and so should be prefixed with \$ whilst programming. The PAUSE and PRNT SCRN keys cannot be used reliably as they have a special long multi-digit code. Also note that some keys may not work correctly when the 'Nums Lock' LED is set on with the keyed command.

To overcome some of these issues the #variable option has been added to M2 parts. In this case the ASCII character of the keyboard letter is loaded into the variable. Unsupported characters like 'Ctrl' will get an ASCII "?" returned.

For older parts the sample file 'keyin.bas' (installed in the \samples folder) provides details on how you can convert the key presses into ASCII characters by means of a look up table.

Effect of Increased Clock Speed:

This command will automatically use the internal 4MHz resonator for correct operation.

Example:

main:

```

kbin [1000,main],b1
if b1 = $45 then
  low b.1
end if
if b1= $25 then
  high b.1
end if
goto main

```

KEY	CODE	KEY	CODE	KEY	CODE
A	1C	9	46	[54
B	32	`	0E	INSERT	E0,70
C	21	-	4E	HOME	E0,6C
D	23	=	55	PG UP	E0,7D
E	24	\	5D	DELETE	E0,71
F	2B	BKSP	66	END	E0,69
G	34	SPACE	29	PG DN	E0,7A
H	33	TAB	0D	U ARROW	E0,75
I	43	CAPS	58	L ARROW	E0,6B
J	3B	L SHIFT	12	D ARROW	E0,72
K	42	L CTRL	14	R ARROW	E0,74
L	4B	L GUI	E0,1F	NUM	77
M	3A	L ALT	11	KP /	E0,4A
N	31	R SHIFT	59	KP *	7C
O	44	R CTRL	E0,14	KP -	7B
P	4D	R GUI	E0,27	KP +	79
Q	15	R ALT	E0,11	KP EN	E0,5A
R	2D	APPS	E0,2F	KP .	71
S	1B	ENTER	5A	KP 0	70
T	2C	ESC	76	KP 1	69
U	3C	F1	05	KP 2	72
V	2A	F2	06	KP 3	7A
W	1D	F3	04	KP 4	6B
X	22	F4	06	KP 5	73
Y	35	F5	03	KP 6	74
Z	1A	F6	0B	KP 7	6C
0	45	F7	83	KP 8	75
1	16	F8	0A	KP 9	7D
2	1E	F9	01]	5B
3	26	F10	09	;	4C
4	25	F11	78	'	52
5	2E	F12	07	,	41
6	36	PRNT SCR	??	.	49
7	3D	SCROLL	7E	/	4A
8	3E	PAUSE	??		

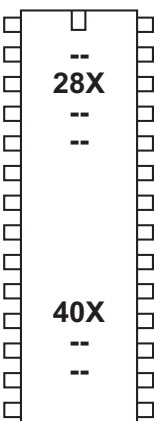
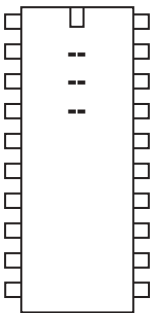
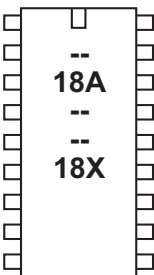
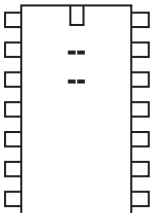
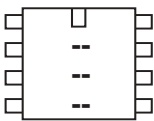

keyin

This command is deprecated, please consider using the kbin command instead.

Syntax:

KEYIN

Function:

Wait until a new keyboard press is received.

Information:

This command is used to wait for a new key press from a computer keyboard (connected directly to the PICAXE - not the keyboard used whilst programming, see keyed command for connection details). All processing stops until the new key press is received. The value of the key press received is placed in the predefined variable 'keyvalue'.

Note the design of the keyboard means that the value of each key is not logical, each key value must be identified from the table on the next page. Some keys use two numbers, the first \$E0 is ignored by the PICAXE and so keyvalue will return the second number. Note all the codes are in hex and so should be prefixed with \$ whilst programming. The PAUSE and PRNT SCRN keys cannot be used reliably as they have a special long multi-digit code. Also note that some keys may not work correctly when the 'Nums Lock' LED is set on with the keyed command.

The sample file 'keyin.bas' (installed in the \samples folder) provides details on how you can convert the key presses into ASCII characters by means of a look up table.

After using this command you may have to perform a 'hard reset' to download a new program to the microcontroller. See the Serial Download section for more details.

Effect of Increased Clock Speed:

This command will only function at 4MHz.

Example:

```
main:
    keyin                                ;wait for new signal
    if keyvalue = $45 then swon1         ;switch on 1
    if keyvalue = $25 then swoff1       ;switch off 1
    goto main

swon1:    high 1
          goto main

swoff1:   low 1
          goto main
```

KEY	CODE	KEY	CODE	KEY	CODE
A	1C	9	46	[54
B	32	`	0E	INSERT	E0,70
C	21	-	4E	HOME	E0,6C
D	23	=	55	PG UP	E0,7D
E	24	\	5D	DELETE	E0,71
F	2B	BKSP	66	END	E0,69
G	34	SPACE	29	PG DN	E0,7A
H	33	TAB	0D	U ARROW	E0,75
I	43	CAPS	58	L ARROW	E0,6B
J	3B	L SHIFT	12	D ARROW	E0,72
K	42	L CTRL	14	R ARROW	E0,74
L	4B	L GUI	E0,1F	NUM	77
M	3A	L ALT	11	KP /	E0,4A
N	31	R SHFT	59	KP *	7C
O	44	R CTRL	E0,14	KP -	7B
P	4D	R GUI	E0,27	KP +	79
Q	15	R ALT	E0,11	KP EN	E0,5A
R	2D	APPS	E0,2F	KP .	71
S	1B	ENTER	5A	KP 0	70
T	2C	ESC	76	KP 1	69
U	3C	F1	05	KP 2	72
V	2A	F2	06	KP 3	7A
W	1D	F3	04	KP 4	6B
X	22	F4	06	KP 5	73
Y	35	F5	03	KP 6	74
Z	1A	F6	0B	KP 7	6C
0	45	F7	83	KP 8	75
1	16	F8	0A	KP 9	7D
2	1E	F9	01]	5B
3	26	F10	09	;	4C
4	25	F11	78	'	52
5	2E	F12	07	,	41
6	36	PRNT SCR	??	.	49
7	3D	SCROLL	7E	/	4A
8	3E	PAUSE	??		

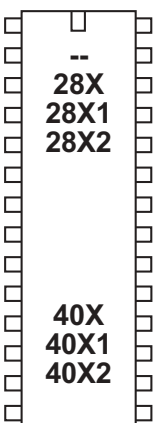
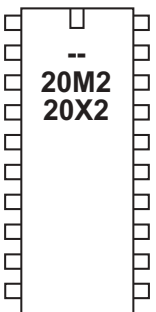
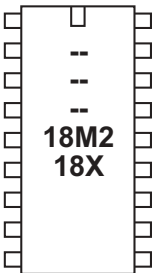
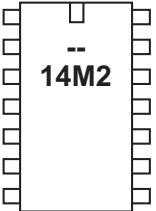
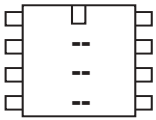

kbled (keyled)

Syntax:

kbled mask

- Mask is a variable/constant which specifies the LEDs to use.

Function:

Set/clear the keyboard LEDs

Information:

This command is used to control the LEDs on a computer keyboard (connected directly to the PICAXE - not the keyboard used whilst programming). The mask value sets the operation of the LEDs.

Mask is used as follows:

- Bit 0 - Scroll Lock (1=on, 0=off)
- Bit 1 - Num Lock (1=on, 0=off)
- Bit 2 - Caps Lock (1=on, 0=off)
- Bit 3-6 - Not Used
- Bit 7 - Disable Flash (1=no flash, 0=flash)

On reset mask is set to 0, and so all three LEDs will flash when the 'keyin' command detects a new key hit. This provides the user with feedback that the key press has been detected by the PICAXE. This flashing can be disabled by setting bit 7 of mask high. In this case the condition of the three LEDs can be manually controlled by setting/clearing bits 2-0.

Effect of Increased Clock Speed:

This command will only function at 4MHz.

Example:

```

main:
    keyled %10000111 ; all LEDs on
    pause 500 ; pause 0.5s
    keyled %10000000 ; all LEDs off
    pause 500 ; pause 0.5s
    goto main ; loop
    
```

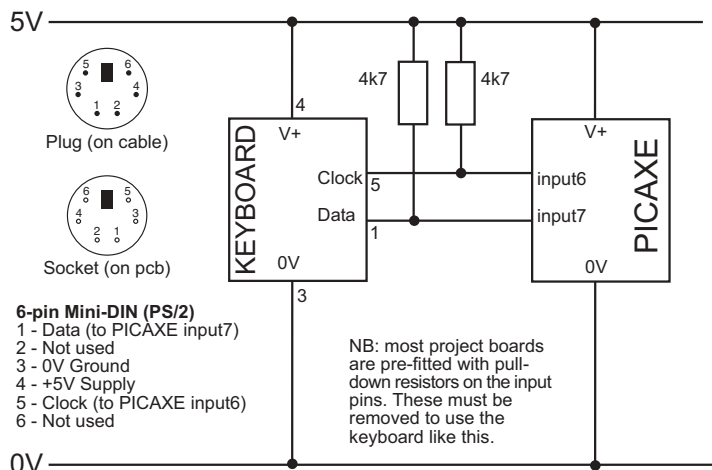

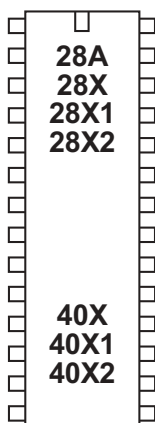
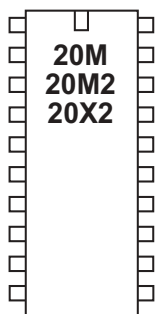
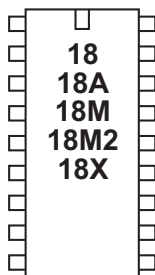
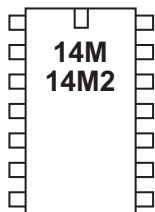
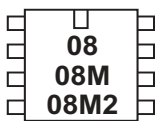
**let***Syntax:***{LET} variable = {-} value ?? value ...**

- Variable will be operated on.

- Value(s) are variables/constants which operate on variable.

Function:

Perform variable manipulation (wordsize-to-wordsize).

Maths is performed strictly from left to right.

The 'let' keyword is optional.

Information:

The microcontroller supports word (16 bit) mathematics. Valid integers are 0 to 65535. All mathematics can also be performed on byte (8 bit) variables (0-255).

The microcontroller does not support fractions or negative numbers.

However it is sometimes possible to rewrite equations to use integers instead of fractions, e.g.

let w1 = w2 / 5.7

is not valid, but

let w1 = w2 * 10 / 57

is mathematically equal and valid.

The mathematical functions supported by all parts are:

+		; add	
-		; subtract	
*		; multiply	(returns low word of result)
**		; multiply	(returns high word of result)
/		; divide	(returns quotient)
//	(or %)	; modulus divide	(returns remainder)
MAX		; limit value to a maximum value	
MIN		; limit value to a minimum value	
AND	&	; bitwise AND	
OR		; bitwise OR	(typed as SHIFT + \ on UK keyboard)
XOR	^	; bitwise XOR	(typed as SHIFT + 6 on UK keyboard)
NAND		; bitwise NAND	
NOR		; bitwise NOR	
ANDNOT	&/	; bitwise AND NOT	(NB this is <i>not</i> the same as NAND)
ORNOT	/	; bitwise OR NOT	(NB this is <i>not</i> the same as NOR)
XNOR	^/	; bitwise XOR NOT	(same as XNOR)

The X1 and X2 parts also support

<<		; shift left	
>>		; shift right	
*/		; multiply	(returns middle word of result)

The X1 and X2 parts also support these unary commands

SIN ; sine of angle (0 to 65535) in degrees (value * 100 is returned)
 COS ; cosine of angle in degrees (value * 100 is returned)
 SQR ; square root
 INV ; invert
 NCD ; encoder (2n power encoder)
 DCD ; decoder (2n power decoder)
 BINTOBCD ; convert binary value to BCD
 BCDTOBIN ; convert BCD value to binary

REV ; reverse a number of bits
 DIG ; return a BCD digit

All mathematics is performed strictly from left to right.

On X1 and X2 parts it is possible to enclose part equations in brackets e.g.

```
let w1 = w2 / ( b5 + 2)
```

On all other chips it is not possible to enclose part equations in brackets e.g.

```
let w1 = w2 / ( b5 + 2)
```

is not valid. This would need to be entered as an equivalent e.g.

```
let w1 = b5 + 2
```

```
let w1 = w2 / w1
```

Further Information:

For further information please see the 'variable mathematics' section of this manual.

Example:

```
main:
    inc b0                ; increment b0
    sound B.7,(b0,50)    ; make a sound
    if b0 > 50 then rest ; after 50 reset
    goto main           ; loop back to start

rest:
    let b0 = b0 max 10   ; limit b0 back to 10
                        ; as 10 is the maximum value
    goto main           ; loop back to start
```

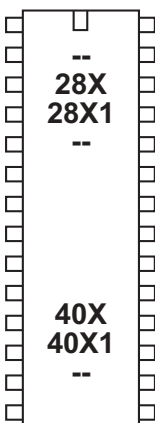
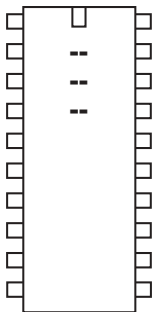
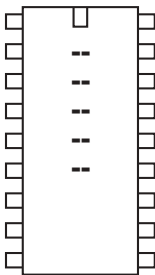
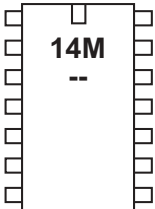
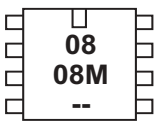

let dirs / dirsc =

For M2 and X2 parts see the next page.

Syntax:

{LET} dirs = value

{LET} dirsc = value

- Value(s) are variables/constants which operate on the data direction register.

Function:

Configure pins as inputs or outputs (let dirs =) (08/08M/08M2)

Configure pins as inputs or outputs on portc (let dirsc =) (14M)

Configure pins as inputs or outputs on portc (let dirsc =) (28X/40X)

Configure pins as inputs or outputs on portc (let dirsc =) (28X1/40X1)

Information:

Some microcontrollers allow inputs to be configured as inputs or outputs. In these cases it is necessary to tell the microcontroller which pins to use as inputs and/or outputs (all are configured as inputs on first power up). There are a number of ways of doing this:

- 1) Use the input/output/reverse commands.
- 2) Use an output command (high, pulsout etc) that automatically configures the pin as an output.
- 3) Use the let dirs = statement.

When working with this statement it is conventional to use binary notation. With binary notation pin 7 is on the left and pin 0 is on the right. If the bit is set to 0 the pin will be an input, if the bit is set to 1 the pin will be an output.

Note that the 8 pin PICAXE have some pre-configured pins (e.g. pin 0 is always an output and pin 3 is always an input). Adjusting the bits for these pins will have no effect on the microcontroller.

Example:

```
let dirs = %00000011 ; switch pins 0 and 1 to outputs
let pins = %00000011 ; switch on outputs 0 and 1
```

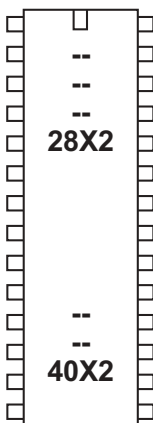
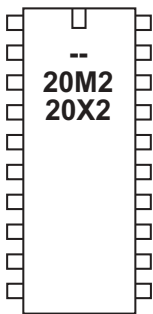
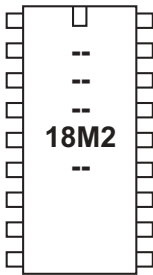
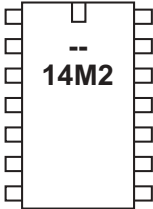
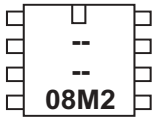
let dirsA/ dirsB/ dirsC/ dirsD =

Syntax:

```
{LET} dirsA = value
```

```
{LET} dirsB = value
```

```
{LET} dirsC = value
```

```
{LET} dirsD = value
```

- Value(s) are variables/constants which operate on the data direction register.

Function:

Configure pins as inputs or outputs.

Information:

Many PICAXE microcontrollers allow pins to be configured as inputs or outputs. In these cases it is necessary to tell the microcontroller which pins to use as inputs and/or outputs (all are configured as inputs on first power up). There are a number of ways of doing this:

- 1) Use the input/output/reverse commands.
- 2) Use an output command (high, pulsout etc) that automatically configures the pin as an output.
- 3) Use the let dirs = statement.

When working with this statement it is conventional to use binary notation. With binary notation pin 7 is on the left and pin 0 is on the right. If the bit is set to 0 the pin will be an input, if the bit is set to 1 the pin will be an output.

Note that some pins are fixed as inputs/outputs and so using this command will have no effect on these pins.

Example:

```
let dirsB = %00000011 ' switch pins 0 and 1 to outputs
let pinsB = %00000011 ' switch on outputs 0 and 1
```

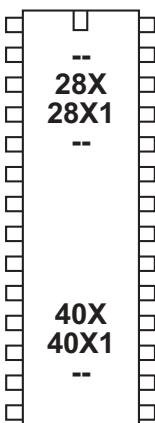
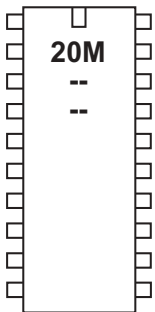
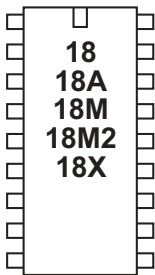
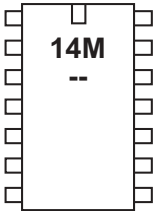
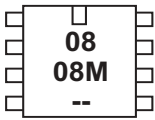

let pins / pinsc =

For M2 and X2 parts see the next page.

Syntax:

```
{LET} pins = value
{LET} pinsc = value
```

- Value(s) are variables/constants which operate on the output port.

Function:

Set/clear all outputs on the main output port (let pins =).

Set/clear all outputs on portc (let pinsc =)

Information:

High and low commands can be used to switch individual outputs high and low. However when working with multiple outputs it is often convenient to change all outputs simultaneously. When working with this statement it is conventional to use binary notation. With binary notation output7 is on the left and output0 is on the right. If the bit is set to 0 the output will be off (low), if the bit is set to 1 the output will be on (high).

Do not confuse the input port with the output port. These are separate ports on all except the 8 pin PICAXE. The command

let pins = pins

means 'make the output port the same as the input port'.

Note that on devices that have input/output bi-directional pins (08 / 08M), this command will only function on pins configured as outputs. In this case it is necessary to configure the pins as outputs (using a let dirs = command) before use of this command.

Example:

```
let pins = %10000011 ; switch outputs 7,0,1 on
pause 1000           ; wait 1 second
let pins = %00000000 ; switch all outputs off
```



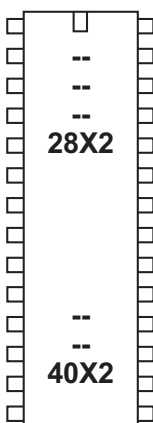
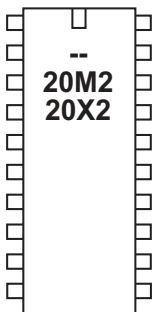
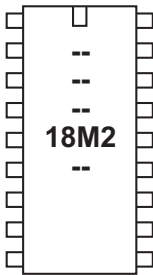
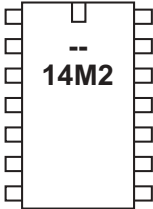
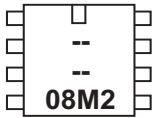

let pinsA / pinsB / pinsC / pinsD =

Syntax:

```
{LET} pinsA = value
```

```
{LET} pinsB = value
```

```
{LET} pinsC = value
```

```
{LET} pinsD = value
```

- Value(s) are variables/constants which operate on the output port.

Function:

Set/clear all outputs on the selected port.

Information:

High and low commands can be used to switch individual outputs high and low. However when working with multiple outputs it is often convenient to change all outputs simultaneously. When working with this statement it is conventional to use binary notation. With binary notation output7 is on the left and output0 is on the right. If the bit is set to 0 the output will be off (low), if the bit is set to 1 the output will be on (high).

Note that this command will only function on pins configured as outputs. In this case it is necessary to configure the pins as outputs (using a let dirsX= command) before use of this command.

Example:

```
let dirsB = %10000011 ; 7,0,1 as outputs
let pinsB = %10000011 ; switch outputs 7,0,1 on
pause 1000 ; wait 1 second
let pinsB = %00000000 ; switch all outputs off
```

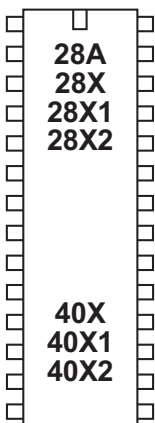
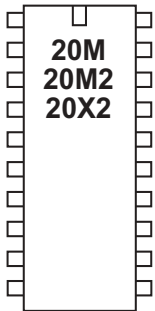
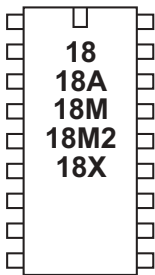
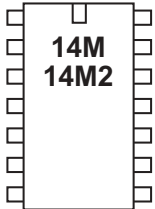
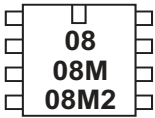

lookdown

Syntax:

LOOKDOWN target,(value0,value1...valueN),variable

- Target is a variable/constant which will be compared to Values.
- Values are variables/constants.
- Variable receives the result (if any).

Function:

Get target's match number (0-N) into variable (if match found).

Information:

The lookdown command should be used when you have a specific value to compare with a pre-known list of options. The target variable is compared to the values in the bracket. If it matches the 5th item (value4) the number '4' is returned in variable. Note the values are numbered from 0 upwards (not 1 upwards). If there is no match the value of variable is left unchanged.

In this example the variable b2 will contain the value 3 if b1 contains "d" and the value 4 if b1 contains "e"

Example:

```
lookdown b1, ("abcde"), b2
```

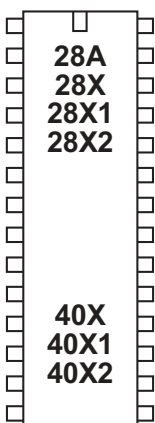
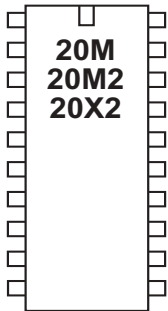
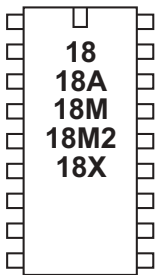
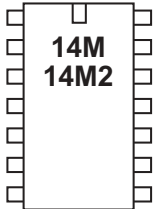
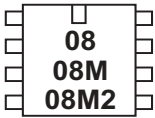

lookup

Syntax:

LOOKUP offset,(data0,data1...dataN),variable

- Offset is a variable/constant which specifies which data# (0-N) to place in Variable.
- Data are variables/constants.
- Variable receives the result (if any).

Function:

Lookup data specified by offset and store in variable (if in range).

Description:

The lookup command is used to load variable with different values. The value to be loaded in the position in the lookup table defined by offset. In this example if b0 = 0 then b1 will equal "a", if b0 =1 then b1 will equal "b" etc. If offset exceeds the number of entries in the lookup table the value of variable is unchanged.

Each lookup is limited to 256 entries, but each entry may be a bit, byte or word constant or variable.

Example:

main:

```
lookup b0,("abcde"),b1 ; put ASCII character into b1
inc b0                 ; increment b0
if b0 < 4 then main   ; loop
end
```

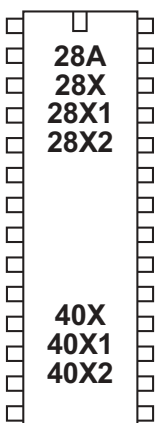
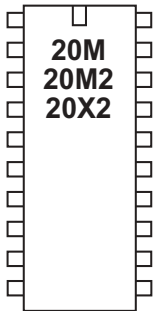
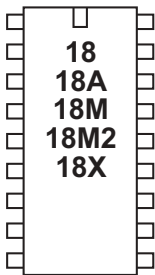
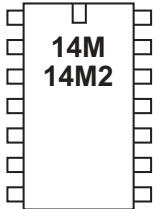
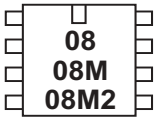
**low***Syntax:***LOW pin {,pin,pin..}**

- Pin is a variable/constant which specifies the i/o pin to use.

Function:

Make pin an output and switch low.

Information:

The low command switches an output off (low).

On microcontrollers with configurable input/output pins this command also automatically configures the pin as an output.

Example:

```

main: high B.1           ; switch on output B.1
      pause 5000        ; wait 5 seconds
      low B.1           ; switch off output B.1
      pause 5000        ; wait 5 seconds
      goto main         ; loop back to start

```

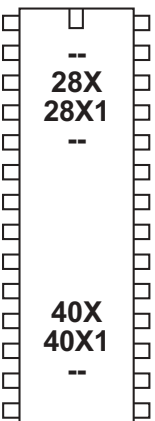
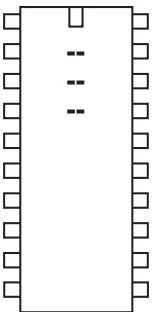
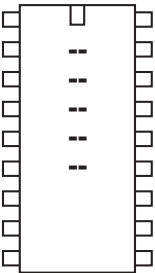
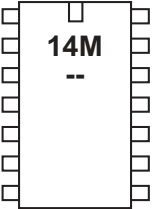
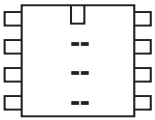

low portc

Syntax:

LOW PORTC pin {,pin,pin...}

- Pin is a variable/constant which specifies the i/o pin to use.

Function:

Make pin on portc output low.

This command is only used on older 14M and 28X/28X1 parts.

For newer M2 and X2 parts use the PORT.PIN notation directly e.g. low C.2

Information:

The high command switches a portc output off (low).

Example:

```
main: high portc 1      ' switch on output 1
      pause 5000        ' wait 5 seconds
      low portc 1       ' switch off output 1
      pause 5000        ' wait 5 seconds
      goto main         ' loop back to start
```

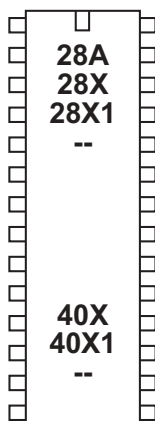
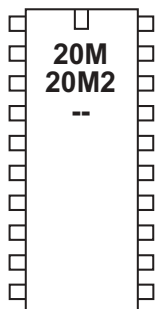
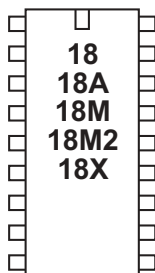
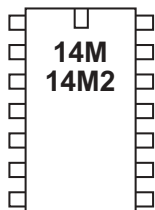
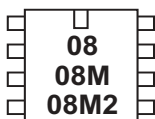

nap



Syntax:

NAP period

- Period is a variable/constant which determines the duration of the reduced-power nap (normally 0-7 but M2 parts also support 0-14).

Function:

Nap for a short period. Power consumption is reduced, but some timing accuracy is lost. A longer delay is possible with the sleep command.

Information:

The nap command puts the microcontroller into low power mode for a short period of time.

When in low power mode all timers are switched off and so the pwmout and servo commands will cease to function (see the 'doze' command). The nominal approximate period of time is given by this table.

Period	Time Delay
0	18ms
1	32ms
2	72ms
3	144ms
4	288ms
5	576ms
6	1.1s
7	2.3s
8	4s
9	8s
10	16s
11	32s
12	64s (1 min)
13	128s (2 mins)
14	256s (4 mins)

Due to tolerances in the microcontrollers internal timers, this time is subject to -50 to +100% tolerance. The external temperature affects these tolerances and so no design that requires an accurate time base should use this command.

A 'hard-reset' will always be required during very long naps.

Effect of increased clock speed:

The nap command uses the internal watchdog timer which is not affected by changes in resonator clock speed.

Example:

```
main: high B.1           ; switch on output B.1
      nap 4              ; nap for 288ms
      low B.1           ; switch off output B.1
      nap 7              ; nap for 2.3 s
      goto main         ; loop back to start
```

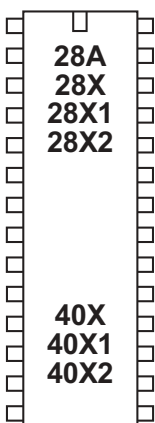
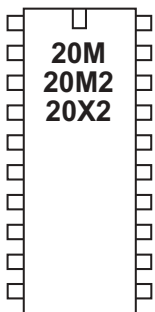
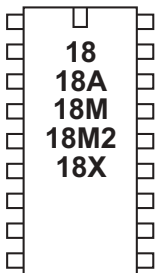
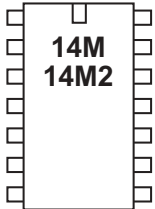
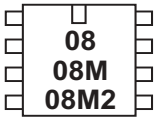
on...goto

Syntax:

ON offset GOTO address0,address1...addressN

- Offset is a variable/constant which specifies which Address# to use (0-N).
- Addresses are labels which specify where to go.

Function:

Branch to address specified by offset (if in range).

Information:

This command allows a jump to different program positions depending on the value of the variable 'offset'. If offset is value 0, the program flow will jump to address0, if offset is value 1 program flow will jump to address1 etc.

If offset is larger than the number of addresses the whole command is ignored and the program continues at the next line.

This command is identical in operation to branch

Example:

```

reset1:let b1 = 0
low B.0
low B.1
low B.2
low B.3

main: pause 1000
inc b1
if b1 > 3 then reset1
on b1 goto btn0,btn1, btn2, btn3
goto main

btn0: high B.0
goto main

btn1: high B.1
goto main

btn2: high B.2
goto main

btn3: high B.3
goto main

```

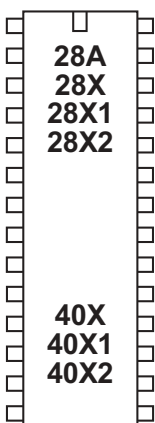
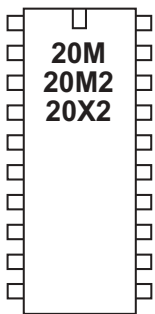
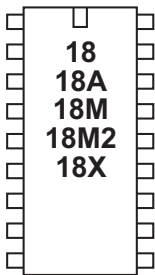
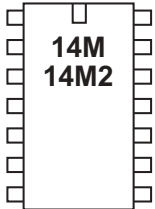
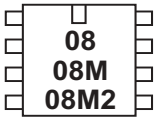

on...gosub

Syntax:

ON offset GOSUB address0, address1, ...addressN

- Offset is a variable/constant which specifies which subprocedure to use (0-N).

- Addresses are labels which specify which subprocedure to gosub to.

Function:

gosub address specified by offset (if in range).

Information:

This command allows a conditional gosub depending on the value of the variable 'offset'. If offset is value 0, the program flow will gosub to address0, if offset is value 1 program flow will gosub to address1 etc.

If offset is larger than the number of addresses the whole command is ignored and the program continues at the next line.

The return command of the sub procedure will return to the line after on...gosub.

This command counts as a single gosub within the compiler.

Example:

```

reset1: let b1 = 0
           low B.0
           low B.1
           low B.2
           low B.3

main:  pause 1000
           inc b1
           if b1 > 3 then reset1
           on b1 gosub btn0,btn1, btn2, btn3
           goto main

btn0:  high B.0
           return

btn1:  high B.1
           return

btn2:  high B.2
           return

btn3:  high B.3
           return

```

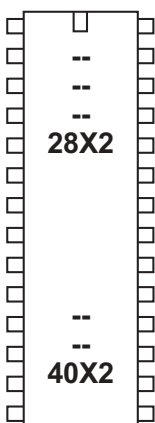
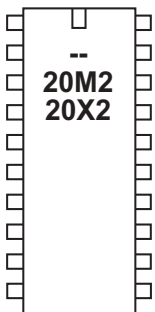
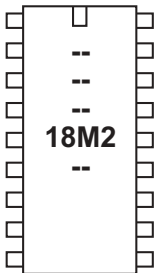
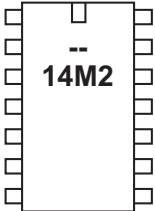
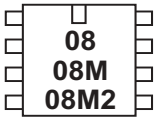

output

Syntax:

OUTPUT pin, pin, pin...

- Pin is a variable/constant which specifies the i/o pin to use.

Function:

Make pin an output.

Information:

This command is only required on microcontrollers with programmable input/output pins. This command can be used to change a pin that has been configured as an input to an output.

All pins are configured as inputs on first power-up (unless the pin is a fixed output). Fixed pins are not affected by this command. These pins are:

08, 08M, 08M2	0 = fixed output	3 = fixed input
14M2	B.0 = fixed output	C.3 = fixed input
18M2	C.3 = fixed output	C.4, C.5 = fixed input
20M2, 20X2	A.0 = fixed output	C.6 = fixed input
28X2, 40X2	A.4 = fixed output	

Example:

```
main:
    input B.1      ; make pin input
    reverse B.1   ; make pin output
    reverse B.1   ; make pin input
    output B.1    ; make pin output
```

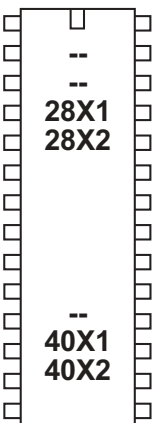
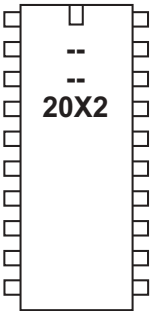
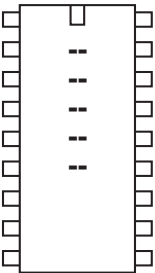
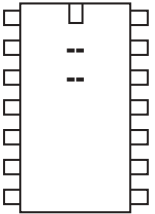
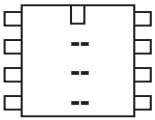

owin

Syntax:

owin pin,mode,(variable, variable...)

- Pin is a variable/constant which specifies input pin to use.

- Mode is a variable/ constant which selects the mode.

Each bit of 'mode' has a separate function:

bit 0 - reset pulse sent before data

bit 1 - reset pulse sent after data

bit 2 - bit mode (receive 1 bit rather than 8 bits (1 byte))

bit 3 - apply strong pullup after data

For convenience these predefined constants may be used:

0	ownoreset	4	ownoreset_bit
1	owresetbefore	5	owresetbefore_bit
2	owresetafter	6	owresetafter_bit
3	owresetboth	7	owresetboth_bit

- Variable(s) receives the data.

Function:

Read data (either full byte or single bit) from one-wire device connected to an input pin, with optional reset pulses before and after the read.

This command cannot be used on the following pins due to silicon restrictions:

20X2 C.6 = fixed input

Information:

Use of one-wire parts is covered in more detail in the separate 'One-Wire Tutorial' datasheet.

This command is used to read data from a one-wire device.

Example:

```
; Read raw temperature value from DS18B20
; (this achieves a similar function to the readtemp12 command)

main:
    owout C.1,%1001,($CC,$44)
                                ; send 'reset' then 'skip ROM'
                                ; then 'convert' then apply 'pullup'
    pause 750                    ; wait 750ms with strong pullup
    owout C.1,%0001,($CC,$BE)
                                ; send 'reset' then 'skip ROM'
                                ; then 'read temp' command
    owin C.1,%0000,(b0,b1) ; read in result
    sertxd (#w0,CR,LF)      ; transmit value
    goto main
```

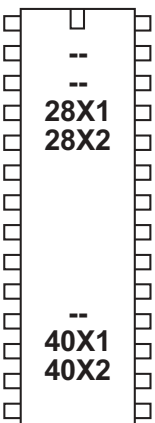
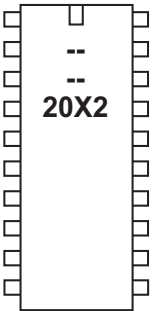
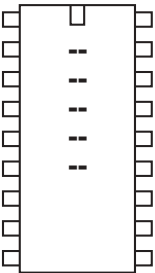
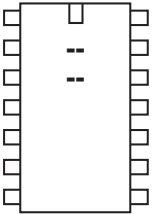
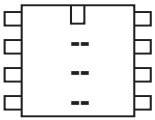

owout

Syntax:

owout pin,mode,(variable,variable...)

- Pin is a variable/constant which specifies the pin to use.

- Mode is a variable/ constant which selects the mode.

Each bit of 'mode' has a separate function:

bit 0 - reset pulse sent before data

bit 1 - reset pulse sent after data

bit 2 - bit mode (send 1 bit rather than 8 bits (1 byte))

bit 3 - apply strong pullup after data

For convenience these predefined constants may be used:

0	ownoreset	4	ownoreset_bit
1	owresetbefore	5	owresetbefore_bit
2	owresetafter	6	owresetafter_bit
3	owresetboth	7	owresetboth_bit

- Variable(s) contain the data to be sent.

Function:

Write data to one-wire device connected to an input pin, with optional reset pulses before and after the write.

Information:

Use of one-wire parts is covered in more detail in the separate 'One-Wire Tutorial' datasheet.

This command is used to write data to a one-wire device. Some devices, such as the DS18B20 temperature sensor, may require a strong pullup after a byte is written.

This command cannot be used on the following pins due to silicon restrictions:

20X2 C.6 = fixed input

Example:

```
; Read raw temperature value from DS18B20
; (this achieves a similar function to the readtemp12 command)

main:
  owout C.1,%1001,($CC,$44)
                                ; send 'reset' then 'skip ROM'
                                ; then 'convert' then apply 'pullup'
  pause 750                      ; wait 750ms with strong pullup
  owout C.1,%0001,($CC,$BE)
                                ; send 'reset' then 'skip ROM'
                                ; then 'read temp' command
  owin C.1,%0000,(b0,b1) ; read in result
  sertxd (#w0,CR,LF)      ; transmit value
  goto main
```

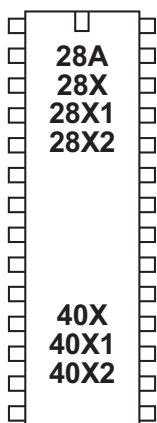
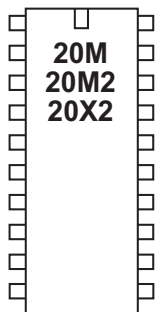
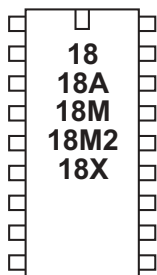
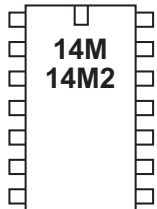
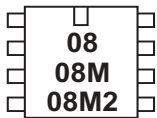

pause



Syntax:

PAUSE milliseconds

- Milliseconds is a variable/constant (0-65535) which specifies how many milliseconds to pause (at 8MHz on X2 parts, 4MHz on all other parts)

Function:

Pause for some time. The duration of the pause is as accurate as the resonator time-base, and presumes a 4MHz resonator (8MHz on X2 parts).

Information:

The pause command creates a time delay (in milliseconds). The longest time delay possible is just over 65 seconds. To create a longer time delay (e.g. 5 minutes) use a for...next loop

```
for b1 = 1 to 5 ' 5 loops
  pause 60000 ' wait 60 seconds
next b1
```

During a pause the only way to react to inputs is via an interrupt (see the setint command for more information). Do not put long pauses within loops that are scanning for changing input conditions.

When using time delays longer than 5 seconds it may be necessary to perform a 'hard reset' to download a new program to the microcontroller. See the Serial Download section for more details.

Effect of increased clock speed:

The timebase is altered if the default frequency is altered, for instance running 4MHz parts at 8MHz will result in a pause half the expected length.

During M2 part multi task programs the accuracy of pause is reduced due to the parallel processing. The minimum resolution is around 20ms in multi task programs. For greater accuracy use single task mode.

Example:

```
main: high B.1           ; switch on output B.1
      pause 5000         ; wait 5 seconds
      low B.1            ; switch off output B.1
      pause 5000         ; wait 5 seconds
      goto main          ; loop back to start
```

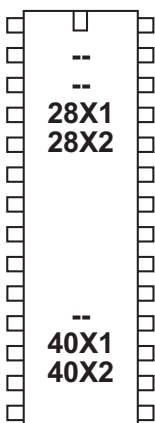
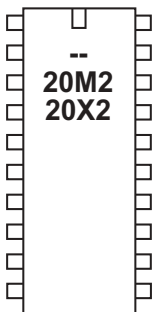
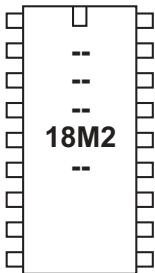
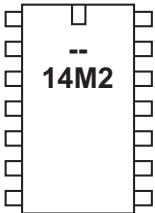
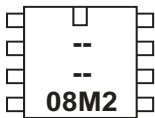

pauseus

Syntax:

PAUSEUS *microseconds*

- *Microseconds* is a variable/constant (0-65535) which specifies how many multiples of 10 microseconds to pause (at 8MHz on X2 parts, else 4MHz).

Function:

Pause for some time. The duration of the pause is as accurate as the resonator time-base, and presumes a 4MHz resonator (8MHz on X2 parts).

Information:

The pauseus command creates a time delay (in multiples of 10 microseconds at 4MHz). As it takes a discrete amount of time to execute the command, small time delays may be inaccurate due to this 'overhead processing' time. This inaccuracy decreases as the delay gets longer.

Effect of increased clock speed:

The timebase is reduced to 5us at 8MHz and 2.5us at 16MHz (non-X2 parts).

Example:

```
main: high B.1           ; switch on output B.1
      pauseus 5000      ; wait 50 000us = 50 milliseconds
      low B.1          ; switch off output B.1
      pauseus 5000      ; wait 50 000us = 50 milliseconds
      goto main         ; loop back to start
```

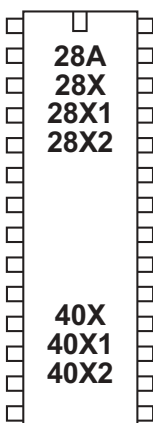
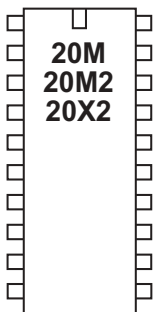
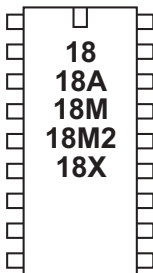
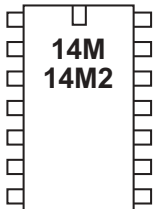
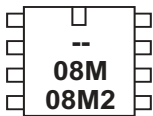

peek



Syntax:

PEEK location,variable,variable,WORD wordvariable...

- Location is a variable/constant specifying a register address.
- Variable is a byte variable where the data is returned. To use a word variable the keyword WORD must be used before the wordvariable name)

Function:

Read data from the microcontroller RAM registers. This allows use of additional storage variables not defined by the bxx variables.

Information:

For M2 and X2 parts see the information on the following page.

For non M2/X2 parts:

The function of the poke/peek commands is two fold.

The most commonly used function is to store temporary byte data in the microcontrollers spare 'storage variable' memory. This allows the general purpose variables (b0, b1 etc.) to be re-used in calculations.

Addresses \$50 to \$7E are general purpose registers that can be used freely.

Addresses \$C0 to \$EF can also be used by PICAXE-18X.

Addresses \$C0 to \$FF can also be used by PICAXE-28X, 40X

Addresses \$C0 to \$EF can also be used by PICAXE-28X1, 40X1

The second function of the peek command is for experienced users to study the internal microcontroller SFR (special function registers).

Addresses \$00 to \$1F and \$80 to \$9F are special function registers (e.g. PORTB) which determine how the microcontroller operates. Avoid using these addresses unless you know what you are doing! The command uses the microcontroller FSR register which can address register banks 0 and 1 only.

Addresses \$20 to \$4F and \$A0 to \$BF are general purpose registers reserved for use with the PICAXE bootstrap interpreter. Poking these registers will produce unexpected results and could cause the interpreter to crash.

When word variables are used (with the keyword WORD) the two bytes of the word are saved/retrieved in a little endian manner (ie low byte at address, high byte at address + 1)

Example:

```
peek 80,b1          ; put value of register 80 into variable b1
peek 80, word w1
```

For M2 parts:

The function of the poke/peek commands is amended on M2 parts.

The M2 parts have up to 512 bytes of user RAM.

The peek and poke commands are used to read and write to all 256 bytes of the user RAM. However the lower 28 bytes (addresses 0 to 27) also correspond to the variables b0 to b27. Therefore these lower bytes can be accessed in two ways, via the bxx variable name or via the peek/poke command. The higher variables can only be accessed via the peek/poke commands.

See the peeksfr and pokesfr commands for details on how to access the internal microcontroller SFR (special function registers).

Note that on the 18M2 part bytes 128-255 are reserved during parallel multi-tasking mode (they are freely available in single task mode). This is a restriction of the limited available RAM on this particular part and does not apply to the 14M2/20M2 parts.

Example:

```
peek 80,b1 ; put value of register 80 into variable b1
```

For X2 parts:

The function of the poke/peek commands is amended on X2 parts.

The 20X2 parts have 128 bytes of user RAM (+128 more in scratchpad)

The 28X2 parts have 256 bytes of user RAM (+1024 more in scratchpad)

The 40X2 parts have 256 bytes of user RAM (+1024 more in scratchpad)

The peek and poke commands are used to read and write to all 256 bytes of the user RAM. However the lower 56 bytes (addresses 0 to 55) also correspond to the variables b0 to b55. Therefore these lower bytes can be accessed in two ways, via the bxx variable name or via the peek/poke command. The higher variables can only be accessed via the peek/poke commands.

See the peeksfr and pokesfr commands for details on how to access the internal microcontroller SFR (special function registers).

Example:

```
peek 80,b1 ; put value of register 80 into variable b1
```

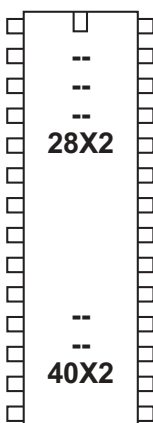
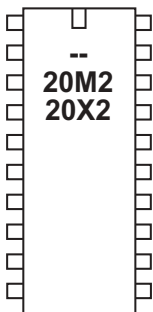
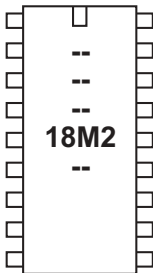
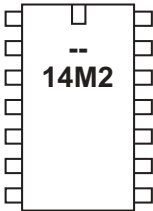
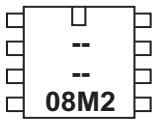

peeksfr

Syntax:

PEEK\$FR location,variable,variable,...

- Location is a variable/constant specifying a register address. Valid values are 0 to 255 (not all implemented, see below).
- Variable is a byte variable where the data is returned.

Function:

Read data from the microcontroller special function registers. This allows experienced users to read the on-board peripheral microcontroller settings. This command is for M2 and X2 parts only, for other parts see the peek command.

Information:

The peeksfr command is for experienced users to study the internal microcontroller SFR (special function registers).

Only SFRs associated with peripherals (e.g. ADC or timers) may be accessed. Peeking or poking SFRs associated with PICAXE program operation (e.g. FSR, EEPROM or TABLE registers) will cause the PICAXE chip to immediately reset.

X2 parts

As location can only take the value 0-255 on X2 locations taken from the Microchip datasheet drop the initial 'F' from the hexadecimal value
e.g. BAUDCON FB8h becomes \$B8

M2 parts

As location can only take the value 0-255 the value for M2 locations taken from the Microchip datasheet are created as follows:

Bit 7-5 Memory Bank \$00-\$07

Bit4-0 Addresses \$0C to \$1F on this bank

(\$00-\$0B are invalid and cause instant reset)

e.g. BAUDCON, address 01Fh on bank 3, becomes %011 1111

Example:

```
peeksfr $9B,b1 ; Read OSCTUNE into variable b1
```

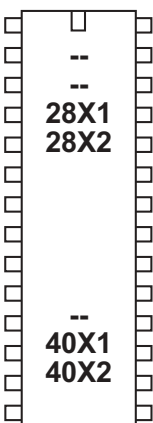
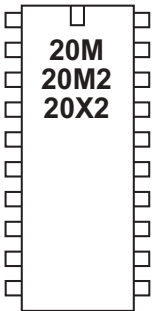
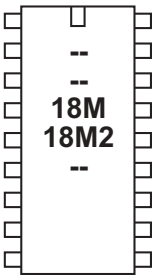
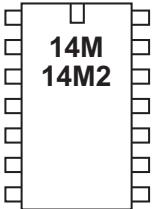
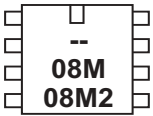

play



Syntax:

PLAY pin, tune (all non-8 pin parts)

PLAY pin, tune, LED_mask (M2 parts only)

PLAY tune, LED_option (8 pin devices only)

- pin is a variable/constant which specifies the i/o pin to use (not available on 8 pin PICAXE parts, which are fixed to using output 2).
- Tune is a variable/constant (0 - 3) which specifies which tune to play
 - 0 - Happy Birthday
 - 1 - Jingle Bells
 - 2 - Silent Night
 - 3 - Rudolph the Red Nosed Reindeer
- LED_mask (M2 parts only) is a variable/constant which specifies if other PICAXE outputs (on the same port as the piezo) flash at the same time as the tune is being played. For example use %00000011 to flash output 0 and 1.
- LED_option (08M/08M2 only) is a variable/constant (0 -3) which specifies if other 8pin PICAXE outputs flash at the same time as the tune is being played.
 - 0 - No outputs
 - 1 - Output 0 flashes on and off
 - 2 - Output 4 flashes on and off
 - 3 - Output 0 and 4 flash alternately

Function:

Play an embedded tune out of the PICAXE output pin.

Description:

PICAXE chips can play musical tones. The PICAXE is supplied with up to 4 pre-programmed internal tunes, which can be output via the play command. As these tunes are already included within the PICAXE bootstrap code, they use very little user program memory. To generate your own tunes use the 'tune' command, which can play any "mobile phone" style RTTIL tune.

See the Tune command for suitable piezo / speaker circuits.

The PICAXE-08M has 4 internal tunes, other parts have less. However on these other parts the 'missing' tunes (Silent Night / Rudolph etc.) are automatically downloaded via the compiler as the appropriate 'tune' command. Therefore the play command will always work on all 4 tunes.

Effect of increased clock speed:

Parts automatically drop to 4MHz to process this command.

Example:

; (8 pin parts only)

play 3,1 ; rudolf red nosed reindeer with output 0 flashing

; (all other parts)

play 2,1 ; jingle bells on output pin 2

; (18M2)

play B.3, 1, %00000011 ; output B.3 with B.0 and B.1 flashing

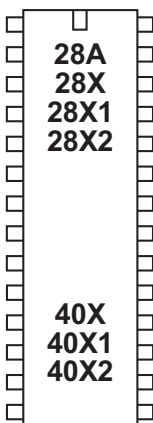
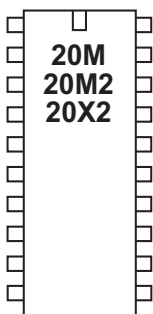
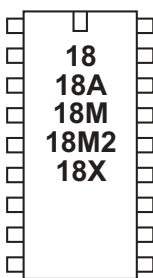
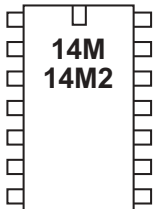
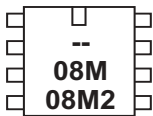

poke



Syntax:

POKE location,data,data,WORD wordvariable...

- Location is a variable/constant specifying a register address.
- Data is a variable/constant which provides the data byte to be written. To use a word variable the keyword WORD must be used before the wordvariable)

Function:

Write data into FSR location. This allows use of registers not defined by b0, b1 etc.

Information:

For M2 and X2 parts see the information on the following page.

For non M2 / X2 parts:

The function of the poke/peek commands is two fold.

The most commonly used function is to store temporary byte data in the microcontrollers spare 'storage variable' memory. This allows the general purpose variables (b0,b1 etc) to be re-used in calculations. Remember that to save a word variable two separate poke/peek commands will be required - one for each of the two bytes that form the word.

Addresses \$50 to \$7E are general purpose registers that can be used freely.

Addresses \$C0 to \$EF can also be used by PICAXE-18X.

Addresses \$C0 to \$FF can also be used by PICAXE-28X, 40X

Addresses \$C0 to \$EF can also be used by PICAXE-28X1, 40X1

The second function of the poke command is for experienced users to write values to the internal microcontroller SFR (special function registers)

Addresses \$00 to \$1F and \$80 to \$9F are special function registers (e.g. PORTB) which determine how the microcontroller operates. Avoid using these addresses unless you know what you are doing! The command uses the microcontroller FSR register which can address register banks 0 and 1 only.

Addresses \$20 to \$4F and \$A0 to \$BF are general purpose registers reserved for use with the PICAXE bootstrap interpreter. Poking these registers will produce unexpected results and could cause the interpreter to crash.

When word variables are used (with the keyword WORD) the two bytes of the word are saved/retrieved in a little endian manner (ie low byte at address, high byte at address + 1)

Example:

```
poke 80,b1          ' save value of b1 in register 80
poke 80, word w1
```

For M2 parts:

The function of the poke/peek commands is amended on M2 parts.

The M2 parts have up to 512 bytes of user RAM.

The peek and poke commands are used to read and write to all 256 bytes of the user RAM. However the lower 28 bytes (addresses 0 to 27) also correspond to the variables b0 to b27. Therefore these lower bytes can be accessed in three ways, via the bxx variable name or via the peek/poke command or via the @bptr variable. The higher variables can be accessed via the peek/poke commands or @bptr variable.

See the peeksfr and pokesfr commands for details on how to access the internal microcontroller SFR (special function registers).

Note that on the 18M2 part bytes 128-255 are reserved during parallel multi-tasking mode (they are freely available in single task mode). This is a restriction of the limited available RAM on this particular part and does not apply to the 14M2/20M2 parts.

Example:

```
poke 80,b1 ; poke value of variable b1 into register 80
```

For X2 parts:

The function of the poke/peek commands is amended on X2 parts.

The 20X2 parts have 128 bytes of user RAM (+128 more in scratchpad)

The 28X2 parts have 256 bytes of user RAM (+1024 more in scratchpad)

The 40X2 parts have 256 bytes of user RAM (+1024 more in scratchpad)

The peek and poke commands are used to read and write to all 256 bytes of the user RAM. However the lower 56 bytes (addresses 0 to 55) also correspond to the variables b0 to b55. Therefore these lower bytes can be accessed in three ways, via the bxx variable name or via the peek/poke command or via the @bptr variable. The higher variables can be accessed via the peek/poke commands or @bptr variable.

See the peeksfr and pokesfr commands for details on how to access the internal microcontroller SFR (special function registers).

Example:

```
poke 80,b1 ; poke value of variable b1 into register 80
```

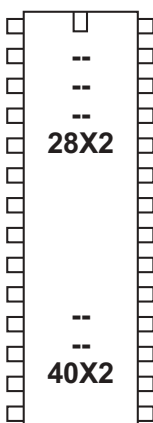
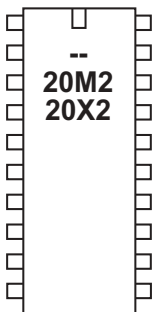
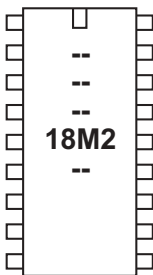
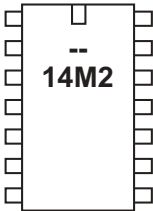
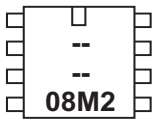

pokesfr

Syntax:

POKESFR location,data,data,...

- Location is a variable/constant specifying a register address. Valid values are 0 to 255 (not all implemented, see below).
- Data is a variable/constant which provides the data byte to be written.

Function:

Write data to the microcontroller special function registers. This allows experienced users to adjust the on-board peripheral microcontroller settings. This command is for M2 and X2 parts only, for other parts see the poke command.

Information:

The pokesfr command is for experienced users to adjust the internal microcontroller SFR (special function registers).

Only SFRs associated with peripherals (e.g. ADC or timers) may be accessed. Peeking or poking SFRs associated with PICAXE program operation (e.g. FSR, EEPROM or TABLE registers) will cause the PICAXE chip to immediately reset.

X2 parts

As location can only take the value 0-255 on X2 locations taken from the Microchip datasheet drop the initial 'F' from the hexadecimal value
e.g. BAUDCON FB8h becomes \$B8

M2 parts

As location can only take the value 0-255 the value for M2 locations taken from the Microchip datasheet are created as follows:

Bit 7-5 Memory Bank \$00-\$07

Bit4-0 Addresses \$0C to \$1F on this bank

(\$00-\$0B are invalid and cause instant reset)

e.g. BAUDCON, address 01Fh on bank 3, becomes %011 1111

Example:

pokesfr \$9B,b1 ; put value of variable b1 into OSCTUNE

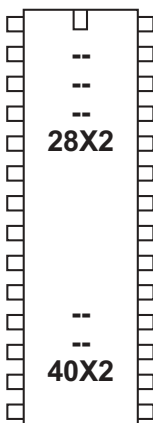
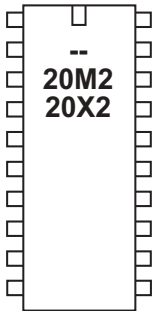
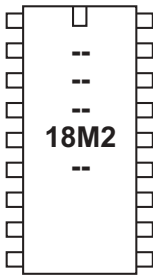
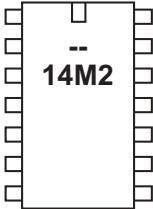
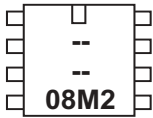

pullup

Syntax:

PULLUP mask

PULLUP OFF (= PULLUP 0)

PULLUP ON (= PULLUP 255)

- mask is a variable/constant specifying a bit mask of the target port.

Function:

Enable or disable the internal weak pull-up resistors on the target device.

Information:

The pullup command can enable/disable the internal pull-up resistors on some input pins. Not all pins have internal pull-up resistors. When a pin is configured as an output the pull-up is automatically disconnected.

An internal pull-up allows the hardware to reliably use, for instance, a switch between the pin and ground without an external resistor.

'Mask' function varies with the PICAXE chip in use. It can contain up to 16 individual bits, bit0 to bit15. Not all pins have pullup functionality due to the internal construction of the microcontroller.

08M2	bit0-bit4 = C.0 to C.4	
14M2	bit0-bit7 = B.0 to B.7	bit8-bit15 = C.0 to C.7
18M2	bit0-bit7 = B.0 to B.7	
20M2	bit0-bit7 = B.0 to B.7	bit8-bit15 = C.0 to C.7
20X2	bit0-bit7 = C.0, C.6, C.7, B.0, B.1 B.5, B.6, B.7	
28X2/40X2	bit0-bit7 = B.0 to B.7	
28X2-5V/40X2-5V	On = all PORTB	
28X2-3V/40X2-3V	bit0-bit7 = B.0 to B.7	

On older 28X2-5V / 40X2-5V parts the pull-ups are on portB only, and cannot be individually masked. Therefore just use 'on' or 'off' to enable/disable all 8 pullups at the same time.

Examples:

```
pullup on           ;enable pullups on 28X2-5V
pullup %11110000   ;enable pullups on portB4-7 on 28X2
pullup %00000111   ;enable pullups on portC on 20X2
```

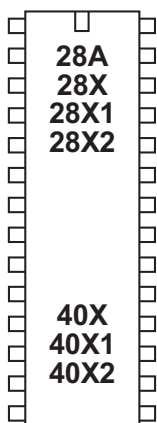
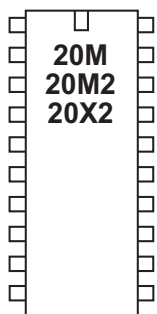
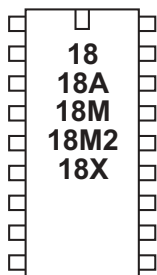
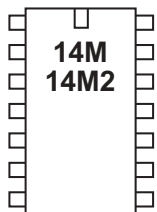
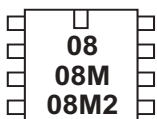

pulsin

Syntax:

PULSIN pin, state, wordvariable

- Pin is a variable/constant which specifies the i/o pin to use.
- State is a variable/constant (0 or 1) which specifies which edge must occur before beginning the measurement in 10us units (at 4MHz resonator).
- Wordvariable receives the result (1-65535). If timeout occurs (0.65536s) the result will be 0.

Function:

Measure the length of an input pulse.

Information:

The pulsing command measures the length of a pulse. In no pulse occurs in the timeout period, the result will be 0. If state = 1 then a low to high transition starts the timing, if state = 0 a high to low transition starts the timing.

Use the count command to count the number of pulses with a specified time period.

It is normal to use a word variable with this command.

Effect of Increased Clock Speed:

4MHz	10us unit	0.65536s timeout
8MHz	5us unit	0.32768s timeout
16MHz	2.5us unit	0.16384s timeout
32MHz	1.25us unit	0.08192s timeout
64MHz	0.625us unit	0.04096s timeout

Example:

pulsin C.3,1,w1 ; record the length of a pulse on C.3 into w1

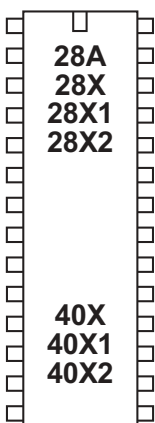
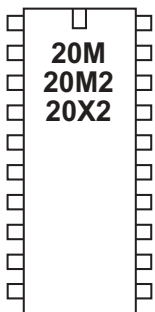
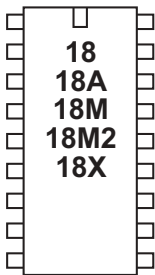
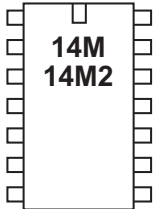
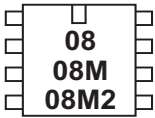

pulsout

Syntax:

PULSOUT pin,time

- Pin is a variable/constant which specifies the i/o pin to use.
- Time is a variable/constant which specifies the period (0-65535) in 10us units (at 4MHz resonator).

Function:

Output a timed pulse by inverting a pin for some time.

Information:

The pulsout command generates a pulse of length time. If the output is initially low, the pulse will be high, and vice versa. This command automatically configures the pin as an output, but for reliable operation you should always ensure this pin is an output before using the command.

Effect of Increased Clock Speed:

4MHz	10us unit
8MHz	5us unit
16MHz	2.5us unit
32MHz	1.25us unit
64MHz	0.625us unit

Example:

main:

```
pulsout B.1,150 ; send a 1.50ms pulse out of pin B.1
pause 20 ; pause 20 ms
goto main ; loop back to start
```

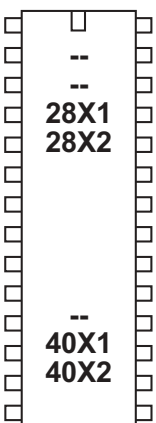
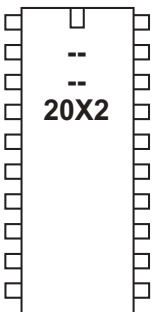
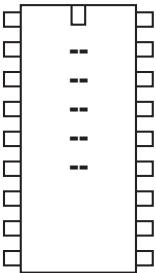
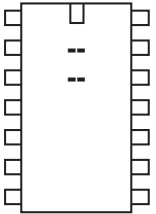
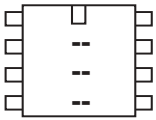

put

Syntax:

PUT location,data,data,WORD wordvariable...

- Location is a variable/constant specifying a scratchpad address. Valid values are
 - 0 to 127 for X1 parts
 - 0 to 127 for 20X2 parts
 - 0 to 1023 for other X2 parts.
- Data is a variable/constant which provides the data byte to be written. To use a word variable the keyword WORD must be used before the wordvariable.

Function:

Write data into scratchpad location.

Information:

The function of the put/get commands is store temporary byte data in the microcontrollers scratchpad memory. This allows the general purpose variables (b0, b1, etc.) to be re-used in calculations.

Put and get have no effect on the scratchpad pointer and so the address next used by the indirect pointer (ptr) will not change during these commands.

When word variables are used (with the keyword WORD) the two bytes of the word are saved/retrieved in a little endian manner (ie low byte at address, high byte at address + 1)

Example:

```
put 1,b1           ; save value of b1 in register 1
put 1, word w1
```

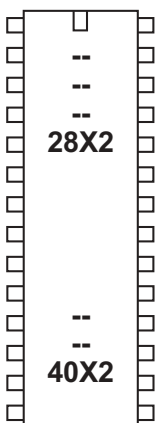
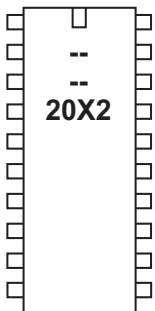
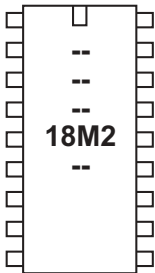
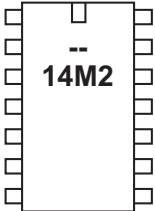
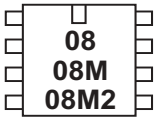

pwm

Syntax:

PWM pin,duty,cycles

- Pin is a variable/constant which specifies the i/o pin to use.
- Duty is a variable/constant (0-255) which specifies analog level.
- Cycles is a variable/constant (0-255) which specifies number of cycles. Each cycle takes about 5ms at 4MHz clock frequency.

Function:

Output pwm then return pin to input.

Information:

This command is historical and hence rarely used. For pwm control of motors etc. the pwmout command is recommended instead.

This pwm command is used to provide 'bursts' of PWM output to generate a pseudo analogue output on the PICAXE pins. This is achieved with a resistor connected to a capacitor connected to ground; the resistor-capacitor junction being the analog output. PWM should be executed periodically to update/refresh the analog voltage.

Example:

main:

```
pwm C.4,150,20    ; send 20 pwm bursts out of pin 4
pause 20          ; pause 20 ms
goto main        ; loop back to start
```

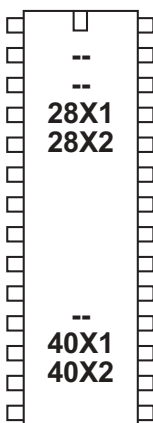
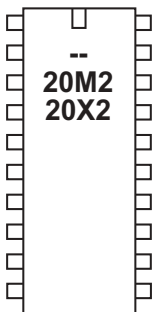
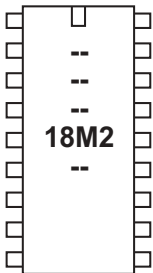
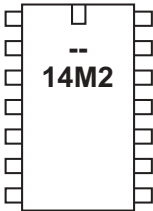
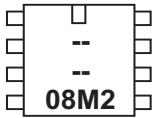

pwm duty

Syntax:

PWMDUTY pin,duty cycles

- Pin is a constant which specifies the i/o pin to use. Note that the pwmout pin is not always a default output pin - see the pinout diagram.
- Duty is a variable/constant (0-1023) which sets the PWM duty cycle. (duty cycle is the mark or 'on time')

Function:

Alter the duty cycle after a pwmout command has been issued.

Information:

On some parts the pwm duty command can be used to alter the pwm duty cycle without resetting the internal timer (as occurs with a pwmout command). A pwmout command must be issued on the appropriate pin before this command will function.

Information:

See the pwmout command for more details.

Example:

init:

```
pwmout C2,150,100 ; start pwm
```

main:

```
pwm duty C2,150 ; set pwm duty
pause 1000 ; pause 1 s
pwm duty C2,50 ; set pwm duty
pause 1000 ; pause 1 s
goto main ; loop back to start
```

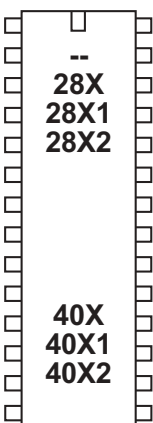
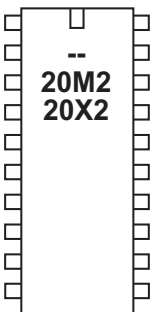
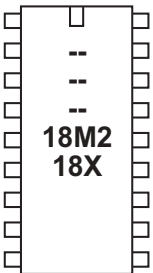
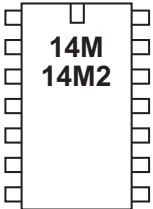
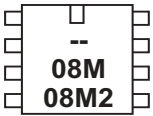

pwmout

Syntax:

PWMOUT pin, period, duty cycles

PWMOUT PWMDIV4, pin, period, duty cycles

PWMOUT PWMDIV16, pin, period, duty cycles

PWMOUT PWMDIV64, pin, period, duty cycles

PWMOUT pin, OFF

- Pin is a variable/constant which specifies the i/o pin to use. Note that the pwmout pin is not always a default output pin - see the pinout diagram.
- Period is a variable/constant (0-255) which sets the PWM period (period is the length of 1 on/off cycle i.e. the total mark:space time).
- Duty is a variable/constant (0-1023) which sets the PWM duty cycle. (duty cycle is the mark or 'on time')

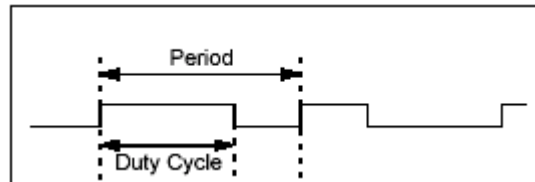

The PWMDIV keyword is used to divide the frequency by 4, 16 or 64. This slows down the PWM.

Function:

Generate a continuous pwm output using the microcontroller's internal pwm module. also see the HPWM command, which can produce the equivalent of pwmout on different output pins.

Information:

This command is **different** to most other BASIC commands in that the pwmout **runs continuously** (in the background) until another pwmout command is sent. Therefore it can be used, for instance, to continuously drive a motor at varying speeds. To stop pwmout issue a 'pwmout pin, off' (=pwmout pin,0,0) command. The PWM period = (period + 1) x 4 x resonator speed

(resonator speed for 4MHz = 1/4000000)

The PWM duty cycle = (duty) x resonator speed

Note that the period and duty values are linked by the above equations. If you wish to maintain a 50:50 mark-space ratio whilst increasing the period, you must also increase the duty cycle value appropriately. A change in resonator will change the formula.

NB: If you wish to know the frequency, PWM frequency = 1 / (the PWM period)

In many cases you may want to use these equations to setup a duty cycle at a known frequency = e.g. 50% at 10 kHz. The Programming Editor software contains a wizard to automatically calculate the period and duty cycle values for you in this situation.

Select the PICAXE>Wizards>pwmout menu to use this wizard.

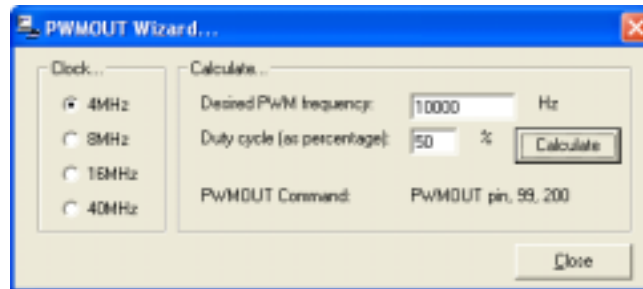

As the pwmout command uses the internal pwm module of the microcontroller there are certain restrictions to its use:

- 1) The command only works on certain pins.
- 2) Duty cycle is a 10 bit value (0 to 1023). The maximum duty cycle value must not be set greater than 4x the period, as the mark 'on time' would then be longer than the total PWM period (see equations above)! Setting above this value will cause erratic behaviour.
- 3) The pwmout module uses a single timer for both the C.1/C.2 pins on 28/40 pin devices. Therefore when using PWMOUT on both these pins the period will be the same for both pins (however different duty cycles are possible).
- 4) The servo command cannot generally be used at the same time as the pwmout command as they both use the same timer (but see * below).
- 5) pwmout stops during nap, sleep, or after an end command
- 6) pwmout 1 can be used at the same time as hpwm (see 3 above)
- 7) pwmout 2 cannot be used as the same time as hpwm
- 8) pwmout is dependant on the clock frequency. On some X1/X2 timing sensitive commands, such as readtemp, the command automatically drops to the internal 4MHz resonator to ensure timing accuracy. This will cause the background pwm to change, so pwm should be stopped during these commands.

* On older PICAXE parts the same internal timer (timer2) is used for both pwmout and servo, so these commands cannot be used at the same time. However some newer parts have additional dedicated internal timers that allow pwmout and servo to work together. This applies to these pwmout channels:

14M2	B.2, B.4	(C.0, C.2 share the servo timer)
18M2	B.3, B.6	
20M2	B.1, C.2	(C.3, C.5 share the servo timer)
28X2	B.0, B.5	(C.1, C.2 share the servo timer)

Note that on X2 parts (only), use of any 'pwmout' command will reset all the other active pwm pins to pwmdiv1. To keep different pins operating at pwmdiv4 or pwmdiv16 reissue a

PWMOUT PWMDIV4 , PIN

command for each of the other pins after the new pwmout command.

To stop pwmout on a pin it is necessary to issue a 'pwmout pin, off' command. Note that this stops all pwm channels sharing that timer (e.g. both C.1 and C.2 will stop together on a 28X2 part). To just stop one channel use 'pwm duty pin, 0'

The pwmout command initialises the pin for pwm operation and starts the internal timers. As each pwmout command always resets the internal timer, the pwm duty command is recommended when rapidly changing the dut (i.e. use an initial pwmout command and then use pwm duty commands after that).

When driving a FET, a pull-down resistor between the PICAXE pin and 0V is essential. The purpose of the pull-down resistor is to hold the FET driver in the correct 'low' state whilst the PICAXE chip initialises upon power up. During this short initialisation period the pwmout pins are not actively driven (ie they 'float') and so the resistor is essential to hold the FET in the off condition.

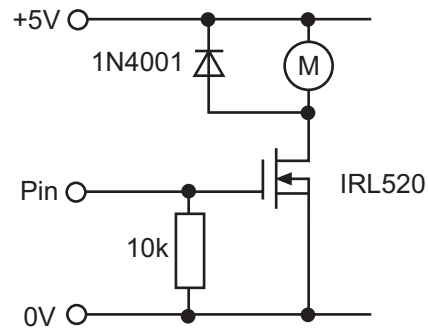

Example:

```

init:
    pwmout C.2,150,150    ; set pwm duty
main:
    pwmduty C.2,150      ; set pwm duty
    pause 1000           ; pause 1 s
    pwmduty C.2,50       ; set pwm duty
    pause 1000           ; pause 1 s
    goto main            ; loop back to start

```

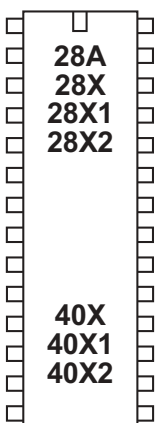
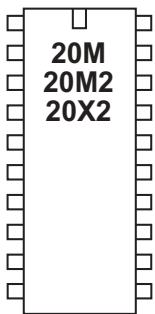
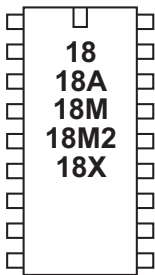
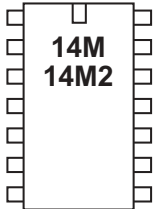
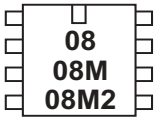

random



Syntax:

RANDOM wordvariable

- Wordvariable is both the workspace and the result. As random generates a pseudo-random sequence it is advised to repeatedly call it within a loop. A word variable **must** be used, byte variables will not operate correctly.

Function:

Generate next pseudo-random number in a wordvariable.

Description:

The random command generates a pseudo-random sequence of numbers between 0 and 65535. All microcontrollers must perform mathematics to generate random numbers, and so the sequence can never be truly random. On computers a changing quantity (such as the date/time) is used as the start of the calculation, so that each random command is different. The PICAXE does not contain such date functionality, and so the sequence it generates will always be identical unless the value of the word variable is set to a different value before the random command is used.

When used with M2, X1, X2 parts you can set the timer running and then use the timer variable to 'seed' the random command. This will give much better results:

```
let w0 = timer      ; seed w0 with timer value
random w0          ; put random value into w0
```

When used with M2 parts you can set the timer running and then use the timer variable to 'seed' the random command. This will give much better results:

```
let w0 = time      ; seed w0 with time value
random w0          ; put random value into w0
```

Another common way to overcome this issue (can be used on all parts) is to repeatedly call the random command within a loop, e.g. whilst waiting for a switch push. As the number of loops will vary between switch pushes, the output is much more random.

If you only require a byte variable (0-255), still use the word variable (e.g. w0) in the command. As w0 is made up of b0 and b1, you can use either of these two bytes as your desired random byte variable.

Example:

```
main:                                ; note random is repeatedly called
    random w0                        ; within the loop
    if pinC.1 =1 then
        let pinsB = b1 ; put random byte value on output pins
        pause 100      ; wait 0.1s
    end if
    goto main
```

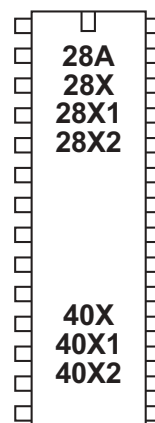
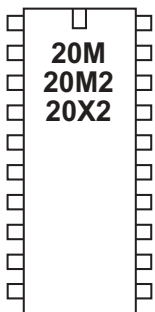
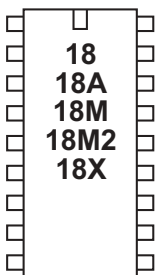
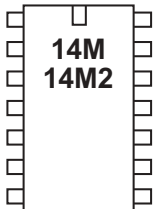
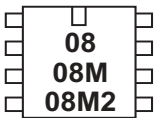
read



Syntax:

READ location,variable,variable, WORD wordvariable

- Location is a variable/constant specifying a byte-wise address (0-255).
- Variable receives the data byte read.To use a word variable the keyword WORD must be used before the wordvariable)

Function:

Read EEPROM data memory byte content into variable.

Information:

The read command allows byte data to be read from the microcontrollers data memory. The contents of this memory is not lost when the power is removed. However the data is updated (with the EEPROM command specified data) upon a new download. To save the data during a program use the write command.

The read command is byte wide, so to read a word variable two separate byte read commands will be required, one for each of the two bytes that makes the word (e.g. for w0, read both b0 and b1).

With the PICAXE-08, 08M, 08M2, 14M, 18, 18M and 18M2 the data memory is shared with program memory. See the EEPROM command for more details.

When word variables are used (with the keyword WORD) the two bytes of the word are saved/retrieved in a little endian manner (ie low byte at address, high byte at address + 1)

Example:

```
main:
    for b0 = 0 to 63           ; start a loop
        read b0,b1           ; read value at b0 into b1
        serout B.7,N2400,(b1) ; transmit value to serial LCD
    next b0                   ; next loop
```

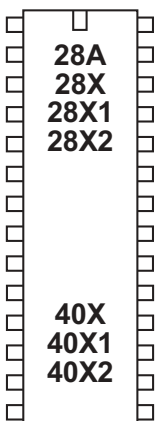
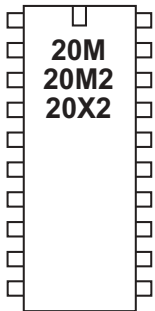
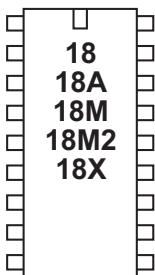
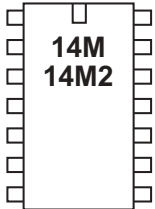
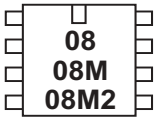

readadc



Syntax:

READADC channel,variable

- channel is a variable/constant specifying the ADC pin

- Variable receives the data byte read.

Function:

Read the ADC channel (8 bit resolution) contents into variable.

On X2 parts the adsetup command must be used to configure the pin as an analogue input. On all other parts configuration is automatic.

Information:

The readadc command is used to read the analogue value from the microcontroller input pins. Note that not all inputs have internal ADC functionality - check the pinout diagrams for the PICAXE chip you are using.

Example:

main:

```
readadc C.1,b1      ; read value into b1
if b1 > 50 then flsh ; jump to flsh if b1 > 50
goto main          ; else loop back to start
```

flsh:

```
high B.1           ; switch on output B.1
pause 5000         ; wait 5 seconds
low B.1            ; switch off output B.1
goto main          ; loop back to start
```

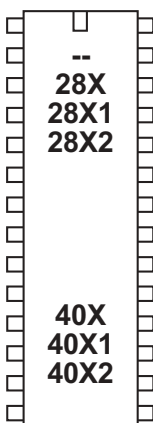
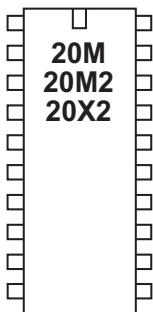
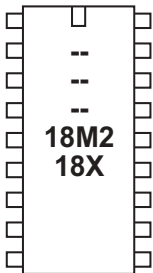
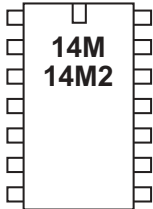
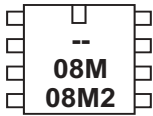

readadc10

Syntax:

READADC10 channel,wordvariable

- channel is a variable/constant specifying the input pin

- wordvariable receives the data word read.

Function:

Read the ADC channel (10 bit resolution) contents into wordvariable.

On X2 parts the adsetup command must be used to configure the pin as an analogue input. On all other parts configuration is automatic.

On X2 parts you must use the ADC channel, not the pin number, in the readadc command (e.g. readadc10 0,w1 NOT readadc10 A.0, w1)

Information:

The readadc10 command is used to read the analogue value from microcontrollers with 10-bit capability. Note that not all inputs have internal ADC functionality - check the table under 'readadc' command for the PICAXE chip you are using.

As the result is 10 bit a word variable must be used - for a byte value use the readadc command instead.

Users of old AXE026 Serial Cable (does not apply to AXE027 USB Cable):

When using the debug command to output 10 bit numbers, the electrical connection to the computer via the serial download cable may slightly affect the ADC values. In this case it is recommended that the 'enhanced' interface circuit is used on a serial connection. The Schottky diode within this circuit reduces this issue.

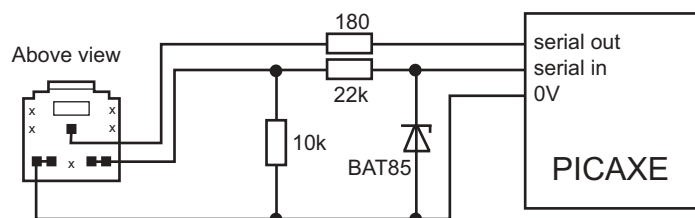

Example:

main:

```

readadc10 C.1,w1      ; read value into b1
debug                 ; transmit to computer
pause 200             ; short delay
goto main             ; loop back to start

```

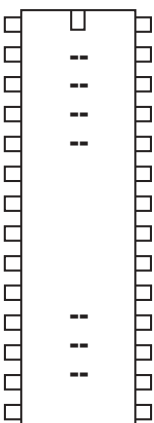
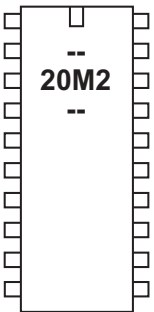
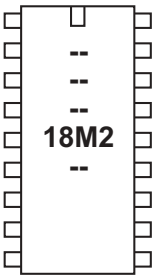
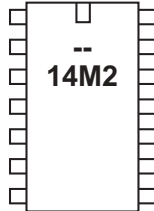
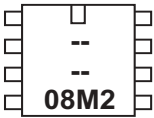

readdac

Syntax:

READDAC variable

- variable is a byte variable to receive the DAC value

Function:

Read the DAC value into variable.

Information:

The readdac command reads the current DAC level, which must have been already setup via dacsetup and daclevel commands. It can be considered as 'readadc on the DAC voltage level'.

Example:

```
main:
    readdac b1          ; read DAC level into b1
```

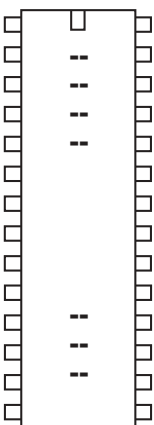
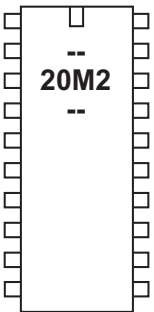
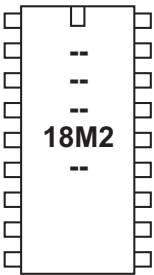
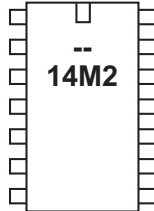
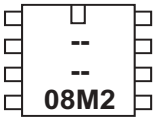

readdac10

Syntax:

READDAC10 *wordvariable*

- *variable* is a word variable to receive the DAC value

Function:

Read the DAC value into variable.

Information:

The readdac command reads the current DAC level, which must have been already setup via dacsetup and daclevel commands. It can be considered as 'readadc10 on the DAC voltage level'.

Example:

```
main:
    readdac10 w1      ; read DAC level into w1
```

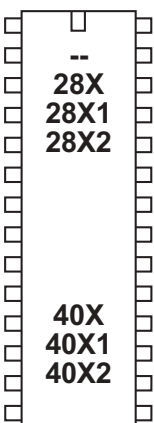
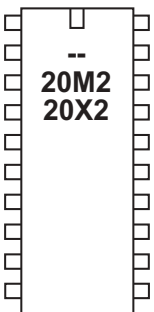
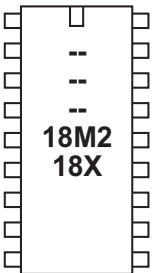
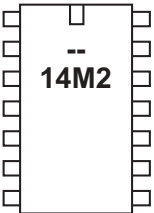
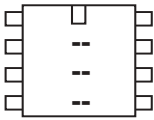

readi2c

This command is deprecated, please consider using the hi2cin command instead.

Syntax:

READI2C (variable,...)

READI2C location,(variable,...)

- Location is an optional variable/constant specifying a byte or word address.

- Variable(s) receives the data byte(s) read.

Function:

The readi2c (i2cread also accepted by the compiler) command reads i2c location contents into variable(s).

Information:

Use of i2c parts is covered in more detail in the separate 'i2c Tutorial' datasheet.

This command is used to read byte data from an i2c device. Location defines the start address of the data read, although it is also possible to read more than one byte sequentially (if the i2c device supports sequential reads).

Location must be a byte or word as defined within the i2cslave command. An i2cslave command must have been issued before this command is used.

If the i2c hardware is incorrectly configured, or the wrong i2cslave data has been used, the value 255 (\$FF) will be loaded into each variable.

Example:

```
; Example of how to use DS1307 Time Clock
; Note the data is sent/received in BCD format.
```

```
; set DS1307 slave address
    i2cslave %11010000, i2cslow, i2cbyte
```

```
; read time and date and debug display
```

```
main:
    readi2c 0, (b0,b1,b2,b3,b4,b5,b6,b7)
    debug
    pause 2000
    goto main
```

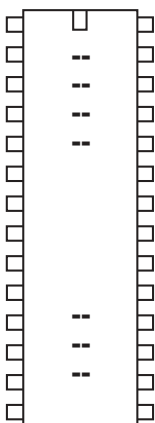
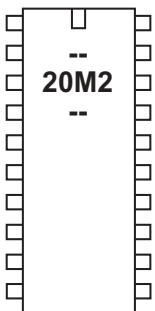
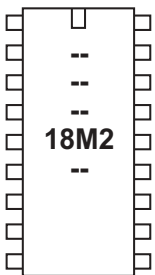
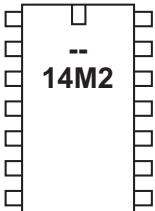
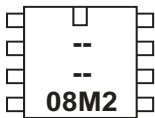

readinternaltemp

Syntax:

READINTERNALTEMP voltage, offset, variable

READINTERNALTEMP voltage, - offset, variable

- Voltage is a constant that indicates the power supply voltage. Options are:

IT_5V0	5V supply
IT_4V5	4.5V supply
IT_4V0	4V supply
IT_3V5	3.5V supply
IT_3V3	3.3V supply
IT_3V0	3V supply
IT_RAW_H	Raw word reading (high setting, above 4V only)
IT_RAW_L	Raw word reading (low setting, any voltage)

- Offset is an optional correction factor, defaults to 0

- Variable receives the temperature data.

Function:

The readinternaltemp command reads the analogue voltage drop across 2 (low) or 4 (high) internal diodes. This gives a very approximate temperature indicator.

Information:

This command is used to provide an indicator of the internal temperature of the chip. It is designed to be used as a cooling failure warning threshold device, not an accurate temperature sensor! For accuracy use a DS18B20 sensor and the readtemp command instead.

Internally an ADC reading is measured across two or four diodes that are linked to the power supply. As temperature changes the ADC reading will also vary. As the ADC reference is the supply voltage the reading will also change with a change in supply (e.g. as a battery runs down).

When IT_RAW_H or IT_RAW_L are used, the raw reading is returned in a word variable. Offset is ignored in these cases and so should be set to 0.

When the other settings are used the PICAXE attempts to mathematically change the value into an approximate reading in degrees Celsius. If desired an 'offset' can be added or subtracted from the raw reading before this conversion occurs to try to improve accuracy.

Kindly note this system can never be an accurate sensor and should only be used as an indicator of extreme temperature only. Thresholds and offsets will vary from part to part. For accuracy use an external DS18B20 instead!

Example:

main:

```
readinternaltemp IT_5V0,0,b1
debug
pause 500
goto main
```

Advanced information:

The mathematical equations used to attempt to convert the raw values into degrees Celsius are:

$$5V0 \quad \text{RAW_H} +/- K -508 * 14 / 13 + 5$$

$$4V5 \quad \text{RAW_H} +/- K -450 * 14 / 15 + 5$$

$$4V0 \quad \text{RAW_H} +/- K -378 * 14 / 18 + 5$$

$$3V5 \quad \text{RAW_L} +/- K -668 * 14 / 10 + 5$$

$$3V3 \quad \text{RAW_L} +/- K -647 * 14 / 10 + 5$$

$$3V0 \quad \text{RAW_L} +/- K -609 * 14 / 10 + 5$$

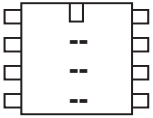

readfirmware

Syntax:

READFIRMWARE variable

- variable is a byte variable to receive the revision value

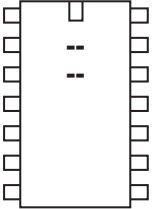

Function:

Read the PICAXE bootstrap firmware revision value into variable.

Information:

The readfirmware command retrieves the PICAXE bootstrap firmware version and loads it into a variable.

Do not confuse the revision (user program) with the firmware version (PICAXE bootstrap version).

Example:

main:

```
    readfirmware b1      ; read firmware version into b1
```

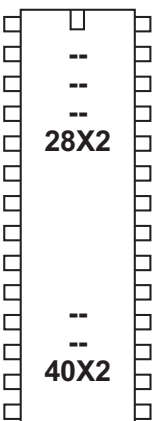
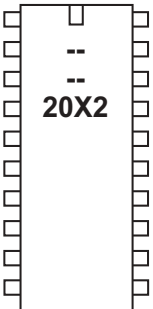
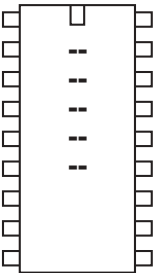

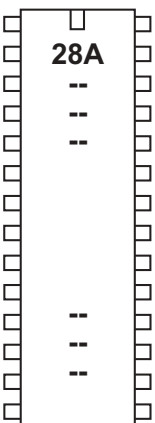
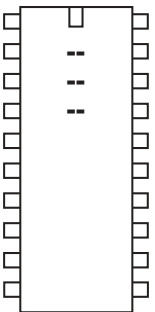
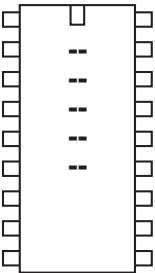
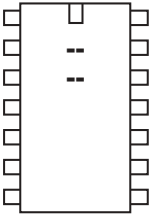
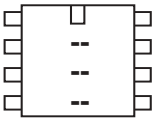

readmem

This command is deprecated.

Syntax:

READMEM location,data

- Location is a variable/constant specifying a byte-wise address (0-255).
- Data is a variable into which the data is read.

Function:

Read FLASH program memory byte data into variable.

Information:

The data memory on the PICAXE-28A is limited to only 64 bytes. Therefore the readmem command provides an additional 256 bytes storage in a second data memory area. This second data area is not reset during a download.

This command is not available on the PICAXE-28X as a larger i2c external EEPROM can be used.

The readmem command is byte wide, so to read a word variable two separate byte read commands will be required, one for each of the two bytes that makes the word (e.g. for w0, read both b0 and b1).

Example:

```
main: for b0 = 0 to 255           ; start a loop
      readmem b0,b1             ; read value into b1
      serout 7,T2400,(b1)       ; transmit value to serial LCD
next b0                          ; next loop
```

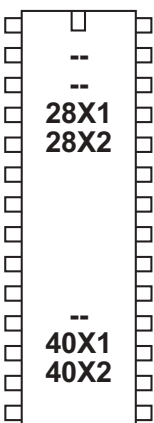
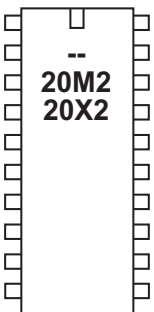
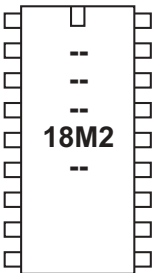
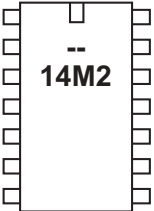
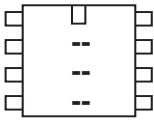

readtable

Syntax:

readtable location,variable

- location is a variable/constant specifying the address
- variable receives the byte value stored at the table location

Function:

Read the value from an embedded lookup table.

Information:

Some PICAXE chips enable lookup data (e.g. LCD messages) to be embedded in a table within the program (via the table command). This is a very efficient way of storing data. See the 'table' command for more details.

Blocks of data may also be transferred to RAM via the tablecopy command.

Example:

```
TABLE 0,("Hello World")      ; save values in table
```

main:

```
  for b0 = 0 to 10           ; start a loop
    readtable b0,b1         ; read value from table
    serout B.7,N2400,(b1)   ; transmit to serial LCD module
  next b0                   ; next character
```

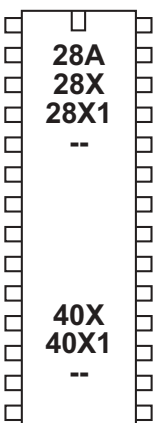
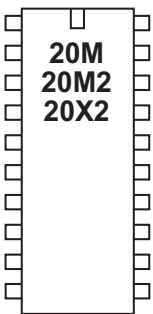
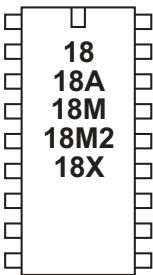
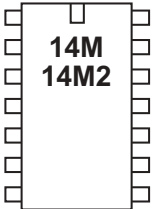
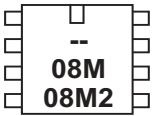

readoutputs

Syntax:

READOUTPUTS *variable*

- *variable* is a byte variable to receive the output pins values

Function:

Read the output pins value into *variable*.

Information:

The current state of the output pins can be read into a variable using the readoutputs command. Note that this is not the same as 'let var = pins', as this let command reads the status of the input (not output) pins.

This command is not normally used with M2, X1 or X2 parts as the outputs can be read directly with 'let var = outpinsX'

Example:

main:

```
readoutputs b1 ; read outputs value into b1
```

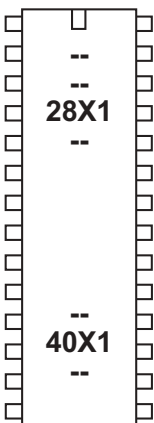
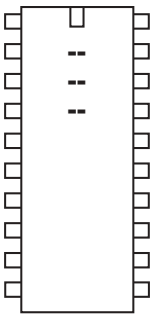
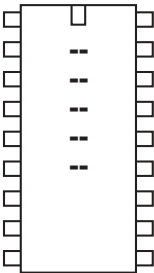
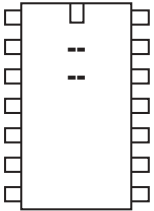
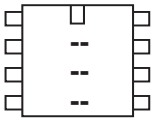

readportc

Syntax:

READPORTC variable

- variable is a byte variable to receive the portc values

Function:

Read the portc value into variable.

Information:

The current state of the portc pins on the 40X1 part can be read into a variable using the readportc command. This command is not required on other parts as you can just use the command 'let var = pinsC'

Example:

```
main:
    readportc b1          ; read value into b1
```

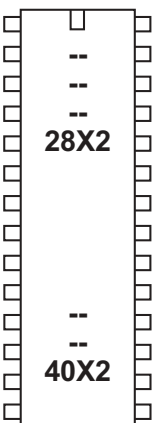
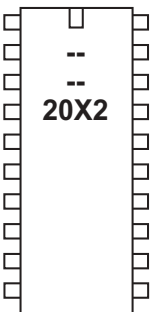
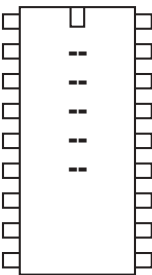
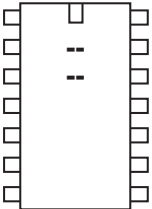
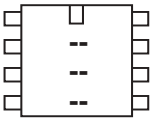

readrevision

Syntax:

READREVISION variable

- variable is a byte variable to receive the revision value

Function:

Read the program slot revision value into variable.

Information:

Using the #revision directive it is possible to embed a revision number of the user code into the downloaded program. The readrevision command retrieves this value and loads it into a variable.

The revision value is also used by the booti2c command. Do not confuse the revision (user program) with the firmware version (PICAXE bootstrap version).

Example:

```
main:
    readrevision b1          ; read revision into b1
```

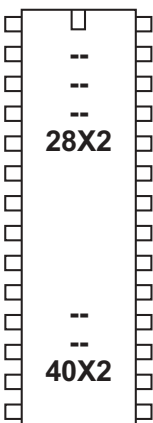
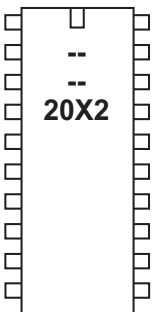
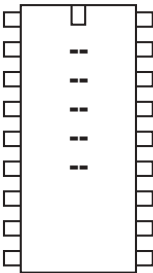
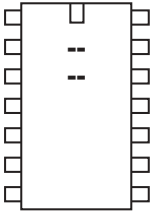
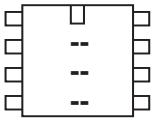

readsilicon

Syntax:

READSILICON *variable*

- *variable* is a byte variable to receive the silicon value

Function:

Read the silicon revision of an X2 part into *variable*.

Bits 7 - 5	PICAXE Type	
000	<i>reserved for future use</i>	
001	PICAXE-20X2	(PIC18F14K22)
010	PICAXE-28X2-5V	(PIC18F2520)
011	PICAXE-40X2-5V	(PIC18F4520)
100	PICAXE-28X2	(PIC18F25K22)
101	PICAXE-40X2	(PIC18F45K22)
110	PICAXE-28X2-3V	(PIC18F25K20)
111	PICAXE-40X2-3V	(PIC18F45K20)

Bits 4 - 0

Microchip Silicon Die Version

Information:

The readsilicon command retrieves information about the silicon dies inside the microcontroller and loads it into a variable. Do not confuse with the revision (user program) or the firmware version (PICAXE bootstrap version).

Example:

```
main:
    readsilicon b1          ; read silicon into b1
```

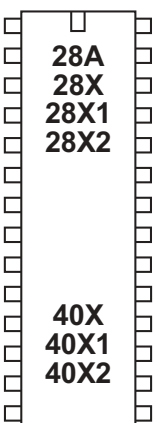
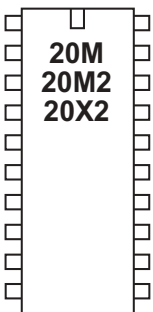
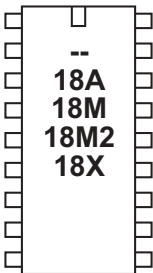
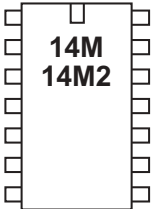
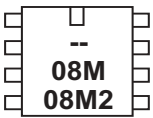

readtemp

Syntax:

READTEMP pin,variable

- Pin is the input pin.
- Variable receives the data byte read.

Function:

Read temperature from a DS18B20 digital temperature sensor and store in variable. The conversion takes up to 750ms. Readtemp carries out a full 12 bit conversion and then rounds the result to the nearest full degree Celsius (byte value). For the full 12 bit value use the readtemp12 command.

Information:

The temperature is read back in whole degree steps, and the sensor operates from -55 to + 125 degrees Celsius. Note that bit 7 is 0 for positive temperature values and 1 for negative values (ie negative values will appear as 128 + numeric value). Note the readtemp command does not work with the older DS1820 or DS18S20 as they have a different internal resolution. This command is not designed to be used with parasitically powered DS18B20 sensors, the 5V pin of the sensor must always be connected.

This command cannot be used on the following pins due to silicon restrictions:

08, 08M, 08M2	C.3, C. 5 = fixed input, C.0 = fixed output
14M, 14M2	C.3 = fixed input, B.0 = fixed output
18M2	C.4, C.5 = fixed input
20M, 20M2, 20X2	C.6 = fixed input

Effect of increased clock speed:

This command only functions at 4MHz. M2, X1 and X2 parts automatically use the internal 4MHz resonator for this command.

Example:

```

main:
    readtemp C.1,b1      ; read value into b1
    if b1 > 127 then neg ; test for negative
    serout B.7,N2400,(#b1) ; transmit value to serial LCD
    goto loop

neg:
    let b1 = b1 - 128    ; adjust neg value
    serout B.7,N2400,("-") ; transmit negative symbol
    serout B.7,N2400,(#b1) ; transmit value to serial LCD
    goto main
    
```

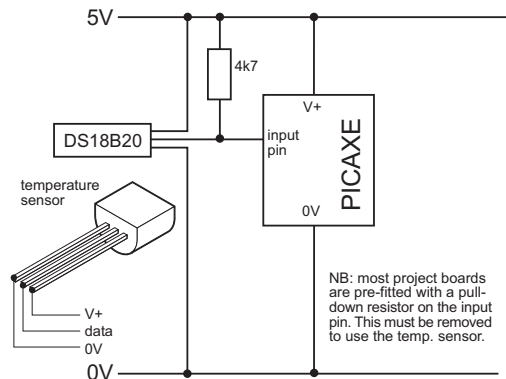

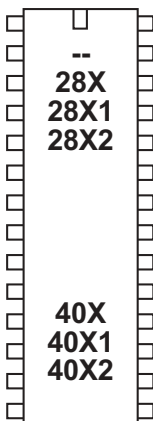
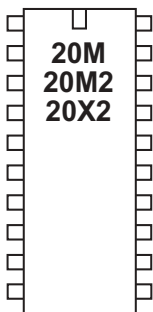
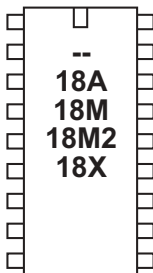
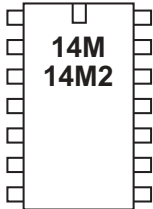
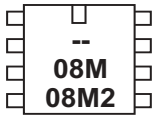

readtemp12

Syntax:

READTEMP12 pin,wordvariable

- Pin is the input pin.

- Variable receives the raw 12 bit data read.

Function:

Read 12 bit temperature data from a DS18B20 digital temperature sensor and store in variable. The conversion takes up to 750ms. Both readtemp and readtemp12 take the same time to convert.

Information:

This command is for advanced users only. For standard 'whole degree' data use the readtemp command.

The temperature is read back as the raw 12 bit data into a word variable (0.0625 degree resolution). The user must interpret the data through mathematical manipulation. See the DS18B20 datasheet for more information on the 12 bit Temperature/Data relationship.

See the readtemp command for a suitable circuit.

Note the readtemp12 command does not work with the older DS1820 or DS18S20 as they have a different internal resolution. This command is not designed to be used with parasitically powered DS18B20 sensors, the 5V pin of the sensor must be connected.

This command cannot be used on the following pins due to silicon restrictions:

08, 08M, 08M2	3 = fixed input
14M, 14M2	C.3 = fixed input
18M2	C.4, C.5 = fixed input
20M, 20M2, 20X2	C.6 = fixed input

Effect of increased clock speed:

This command only functions at 4MHz. M2, X1 and X2 parts automatically use the internal 4MHz resonator for this command.

Example:

```
main:
    readtemp12 1,w1      ; read value into b1
    debug               ; transmit to computer screen
    goto main
```

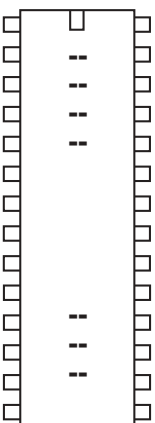
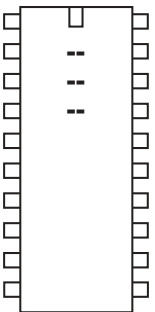
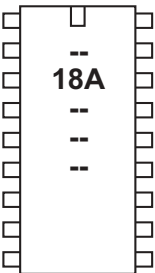
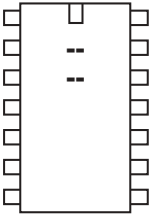
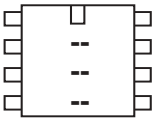

readowclk

Syntax:

readowclk pin

- Pin is a variable/constant which specifies the i/o pin to use.

Function:

Read seconds from a DS2415 clock chip.

Information:

This command only applies to the PICAXE-18A. It is now rarely used as most users prefer to use the more powerful DS1307 i2c part interfaced to a PICAXE-18M2 microcontroller.

The DS2415 is an accurate 'second counter'. Every second, the 32 bit (4 byte) counter is incremented. Time is very accurate due to the use of a watch crystal. Therefore by counting elapsed seconds you can work out the accurate elapsed time. The 32 bit register is enough to hold 136 years worth of seconds. If desired the DS2415 can be powered by a separate 3V cell and so continue working when the main PICAXE power is removed.

Note that after first powering the DS2415 you must use a resetowclk command to activate the clock crystal and reset the counter. See the circuit diagram under the resetowclk command description.

The readowclk command reads the 32 bit counter and then puts the 32 bit value in variables b10 (LSB) to b13 (MSB) (also known as w6 and w7).

Using byte variables:

The number in b10 is the number of single seconds

The number in b11 is the number x 256 seconds

The number in b12 is the number x 65536 seconds

The number in b13 is the number x 16777216 seconds

Using word variables:

The number in w6 is the number of single seconds

The number in w7 is the number x 65536 seconds

Effect of Increased Clock Speed:

This command will only function at 4MHz.

Example:

```
main:
    resetowclk 2    ; reset the clock on pin2
loop1:
    readowclk 2    ; read clock on input2
    debug          ; display the elapsed time
    pause 10000    ; wait 10 seconds
    goto loop1
```

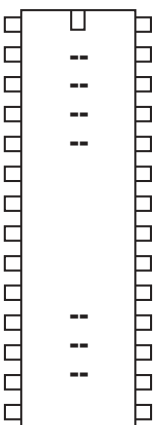
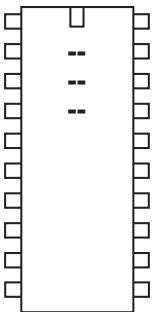
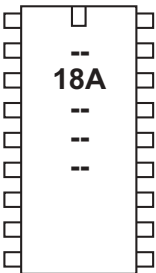
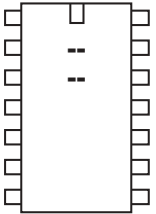
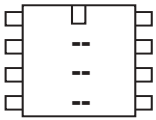

resetowclk

Syntax:

resetowclk pin

- Pin is a variable/constant (0-7) which specifies the i/o pin to use.

Function:

Reset seconds count to 0 on a DS2415 clock chip.

Information:

This command resets the time on a DS2415 one wire clock chip. It also switches the clock crystal on, and so must be used when the chip is first powered up to enable the time counting.

Effect of Increased Clock Speed:

This command will only function at 4MHz.

See the example under the readowclk command.

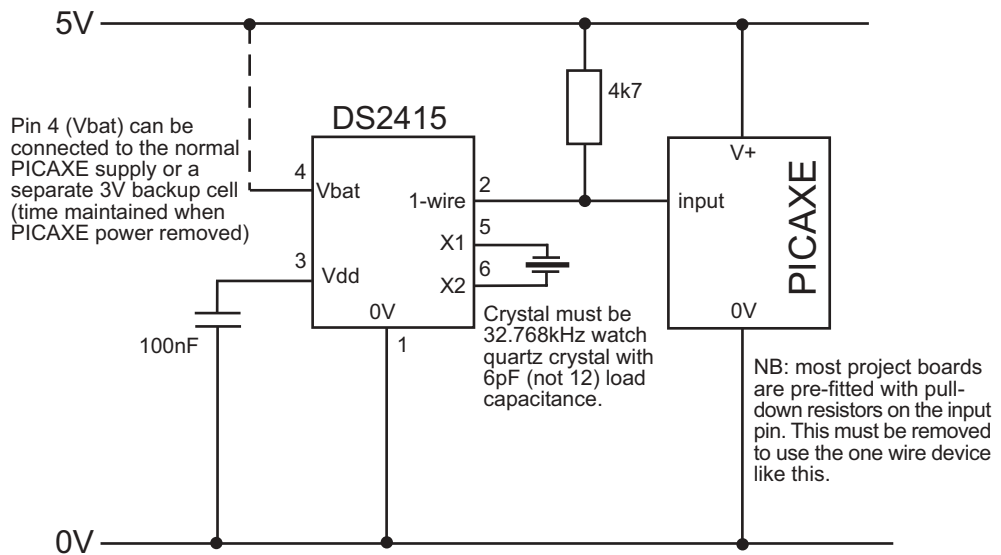

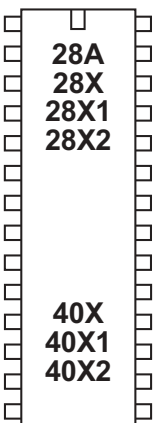
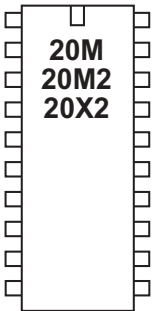
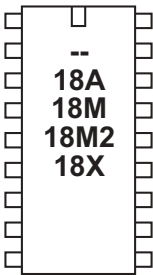
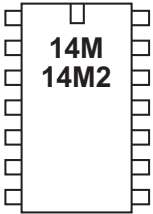
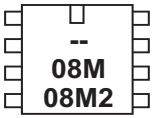

readownsn

Syntax:

readownsn pin

- Pin is a variable/constant which specifies the input pin to use.

Function:

Read serial number from any Dallas/Maxim 1-wire device.

Information:

This command (read-one-wire-serial-number) reads the unique serial number from any Dallas 1-wire device (e.g DS18B20 digital temp sensor, DS2415 clock, or DS1990A iButton).

If using an iButton device (e.g. DS1990A) this serial number is laser engraved on the casing of the iButton.

The readownsn command reads the serial number and then puts the family code in b6, the serial number in b7 to b12, and the checksum in b13

Note that you should not use variables b6 to b13 for other purposes in your program during a readownsn command.

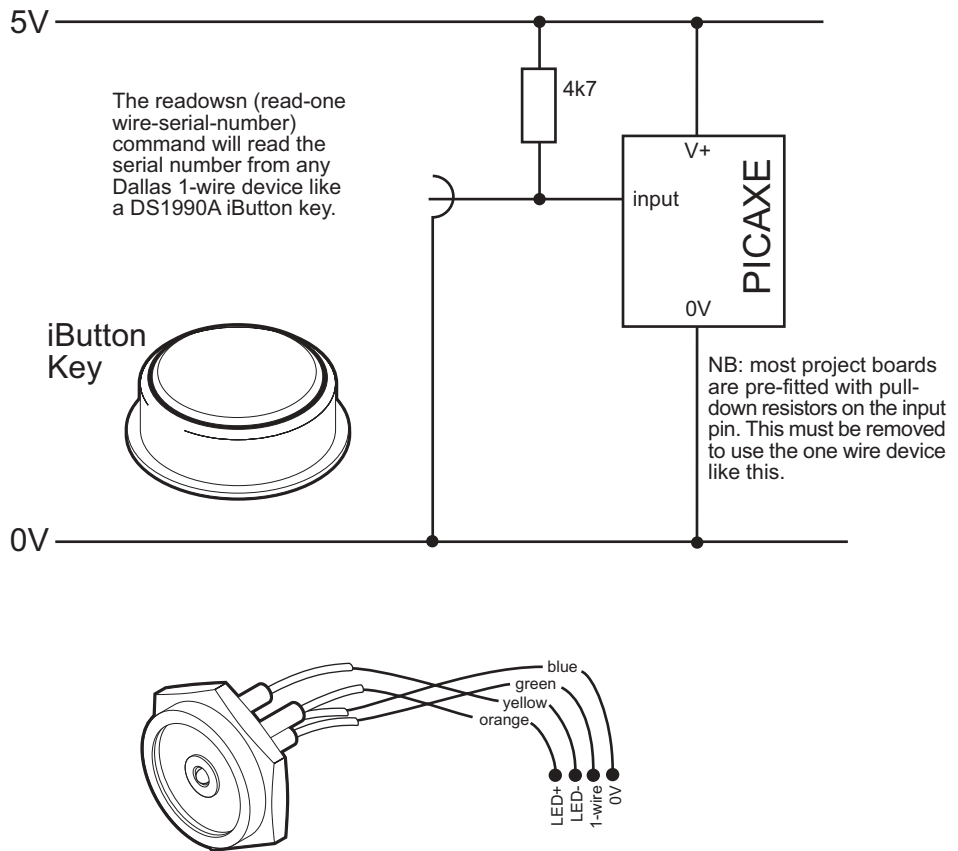

Part RSA002 - iButton Contact probe

This command cannot be used on the following pins due to silicon restrictions:

08, 08M, 08M2	3 = fixed input
14M, 14M2	C.3 = fixed input
18M2	C.4, C.5 = fixed input
20M, 20M2, 20X2	C.6 = fixed input

Example:

main:

```
let b6 = 0 ; reset family code to 0
```

```
; loop here reading numbers until the
; family code (b6) is no longer 0
```

loop1:

```
readown C.2 ; read serial number on input2
if b6 = 0 then loop1
```

```
; Do a simple safety check here.
; b12 serial no value will not likely be FF
; if this value is FF, it means that the device
; was removed before a full read was completed
; or a short circuit occurred
```

```
if b12 = $FF then main
```

```
; Everything is ok so continue
```

```
debug ; ok so display
pause 1000 ; short delay
```

```
goto main
```

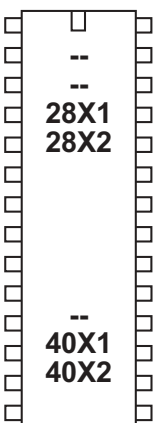
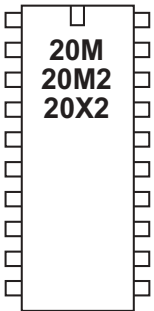
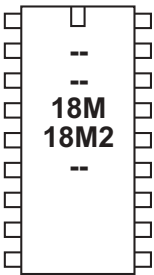
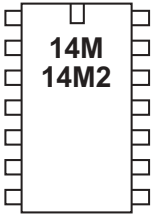
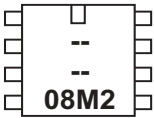

reconnect

Syntax:

RECONNECT

Function:

Reconnect a disconnected PICAXE so that it scans for new downloads.

Information:

The PICAXE chips constantly scan the serial download pin to see if a computer is trying to initialise a new program download. However when it is desired to use the download pin for user serial communication (serrxd command), it is necessary to disable this scanning.

After disconnect is used it will not be possible to download a new program until:

- 1) the reconnect command is issued
- 2) a reset command is issued
- 3) a hardware reset is carried out

Remember that is always possible to carry out a new download by carrying out the 'hard-reset' procedure.

Example:

disconnect

serrxd [1000, timeout],@ptrinc,@ptrinc,@ptr

reconnect

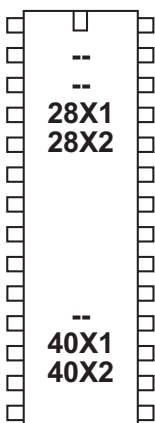
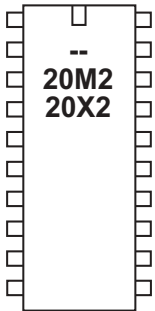
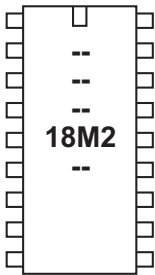
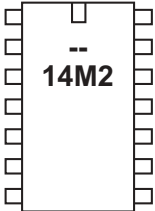
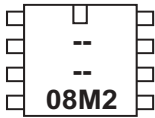

reset

Syntax:

reset

Function:

Force a chip reset. This is the software equivalent of pressing the external reset switch or removing/reconnecting power.

Information:

The reset command is the software equivalent of pressing the external reset switch (if present). The program is reset to the first line and all variables, stacks etc are reset.

Example:

```

main:
    let b2 = 15      ; set b2 value
    pause 2000      ; wait for 2 seconds
    gosub flsh      ; call sub-procedure
    let b2 = 5      ; set b2 value
    pause 2000      ; wait for 2 seconds
    reset           ; start again
  
```

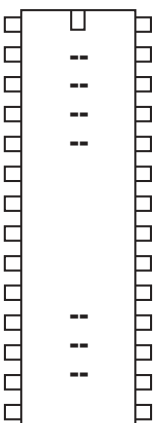
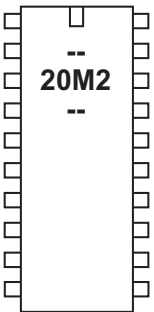
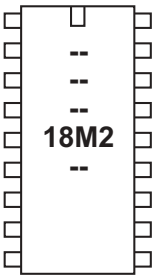
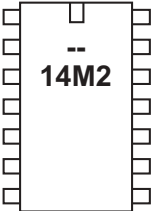
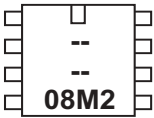

restart

Syntax:

restart task

- task is a variable/constant which indicates which task to restart

Function:

Restart the task.

Information:

M2 parts can process a number of tasks in parallel. The restart command is used to restart a single task back to its first line. If the task is suspended at that point it will also be resumed. All other tasks continue as normal. This command does not reset any variables, to do this a 'reset' command would be needed to reset the entire chip.

Example:

```

start0:
    b3 = 0           ; reset b3
loop0:
    high B.0        ; B.0 high
    pause 1000      ; wait for 1 second
    low B.0         ; B.0 low
    pause 1000      ; wait for 1 second
    inc b3          ; increment variable
    goto loop0      ; loop

start1:
    inc b4          ; increment variable
    if b4 > 10 then ; if b4 > 10 then
        restart 0  ; restart task 0. Var b3 will drop to 0
        b4 = 0
    end if
    debug          ; display variables
    pause 1000
    goto start1
  
```

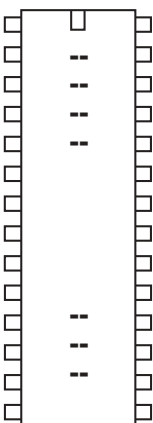
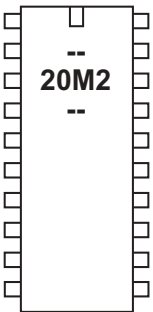
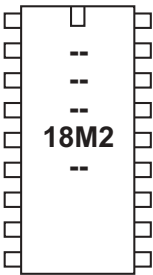
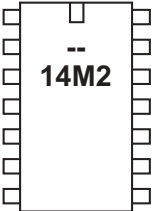
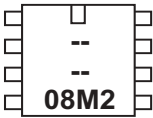
resume

Syntax:

resume task

- task is a variable/constant which indicates which task to restart

Function:

Resume a suspended task.

Information:

M2 parts can process a number of tasks in parallel. The resume command is used to resume a previously suspended task. All other tasks continue as normal. If the task is already running the command is ignored.

Example:

```

start0:
    high B.0           ; B.0 high
    pause 100          ; wait for 0.1 second
    low B.0            ; B.0 low
    pause 100          ; wait for 0.1 second
    goto start0        ; loop

start1:
    pause 5000         ; wait 5 seconds
    suspend 0          ; suspend task 0
    pause 5000         ; wait 5 seconds
    resume 0           ; resume task 0
    goto start1        ; loop
  
```

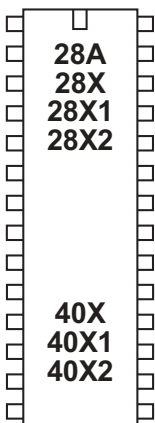
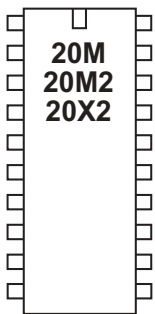
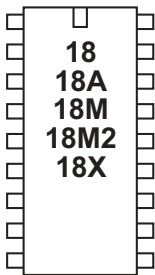
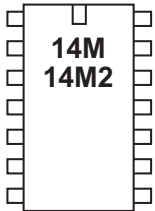
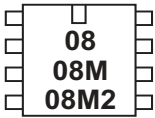

return



Syntax:

RETURN

Function:

Return from subroutine.

Information:

The return command is only used with a matching 'gosub' command, to return program flow back to the main program at the end of the sub procedure. If a return command is used without a matching 'gosub' beforehand, the program flow will crash.

Example:

main:

```

let b2 = 15           ; set b2 value
pause 2000           ; wait for 2 seconds
gosub flsh           ; call sub-procedure
let b2 = 5           ; set b2 value
pause 2000           ; wait for 2 seconds
gosub flsh           ; call sub-procedure
end                  ; stop accidentally falling into sub

```

flsh:

```

for b0 = 1 to b2     ; define loop for b2 times
  high B.1           ; switch on output B.1
  pause 500          ; wait 0.5 seconds
  low B.1            ; switch off output B.1
  pause 500          ; wait 0.5 seconds
next b0              ; end of loop
return               ; return from sub-procedure

```

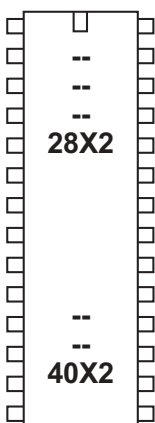
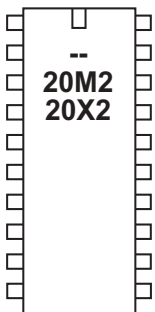
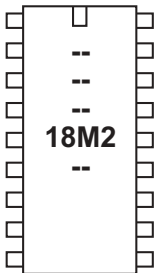
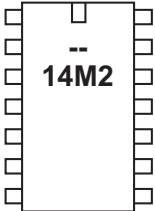
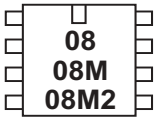

reverse

Syntax:

REVERSE pin, pin, pin...

- Pin is a variable/constant which specifies the i/o pin to use.

Function:

Make pin an output if now input and vice versa.

Information:

This command is only required on microcontrollers with programmable input/output pins. This command can be used to change a pin that has been configured as an input to an output.

All pins are configured as inputs on first power-up (unless the pin is a fixed output). Fixed pins are not affected by this command. These pins are:

08, 08M, 08M2	0 = fixed output	3 = fixed input
14M2	B.0 = fixed output	C.3 = fixed input
18M2	C.3 = fixed output	C.4, C.5 = fixed input
20M2, 20X2	A.0 = fixed output	C.6 = fixed input
28X2, 40X2	A.4 = fixed output	

Example:

```
main:
    input B.1      ; make pin input
    reverse B.1   ; make pin output
    reverse B.1   ; make pin input
    output B.1    ; make pin output
```

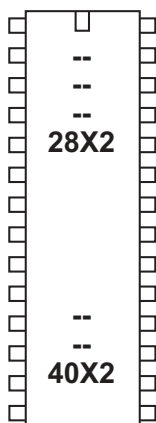
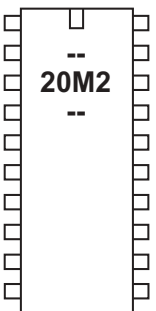
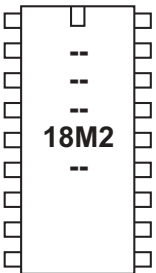
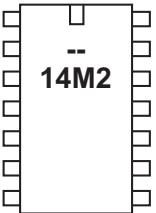
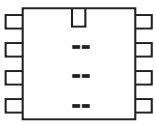

Firmware >= B.3

rfin

Syntax:

rfin pin, variable, variable, variable, variable, variable, variable, variable, variable

- pin is a variable/constant which specifies the i/o pin to use
- variables are 8 individual byte variables to receive the 8 bytes of data

Function:

Receive 8 bytes of Manchester encoded radio data transmitted by a NKM2401 encoder or PICAXE rfout command over a wireless link. Note that the rfin command always receives exactly 8 bytes of data, so exactly 8 data variables are required within this command syntax.

Information:

The rfin command decodes and receives 8 bytes of data transmitter over a radio link from a NKM2401 encoder or rfout command from another PICAXE chip. This provides much more reliable radio communication than using serin commands with low cost RF modules.

Note this command is blocking, no other commands will process whilst the rfin command is waiting for RF data to be received. If a system that can process other commands whilst waiting for data to be received is required, the NKM2401 should be used as a dedicated slave receiver alongside the PICAXE chip. This allows the NKM2401 to receive and store the data at any time, so that the PICAXE chip can then read the data as and when it is ready to do so.

The NKM2401 decoder can be used with all PICAXE chips, even those that do not support the rfin command (as it uses the serin command). For further details about how to use the NKM2401 decoder please see the AXE213 datasheet at:

www.rev-ed.co.uk/docs/axe213.pdf

This datasheet also explains in detail how to use low cost RF modules.

*Using rfin command
(blocking)*

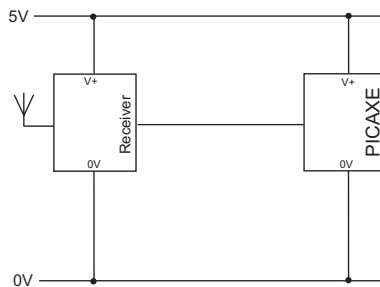

*Using serin command with NKM2401
(non-blocking)*

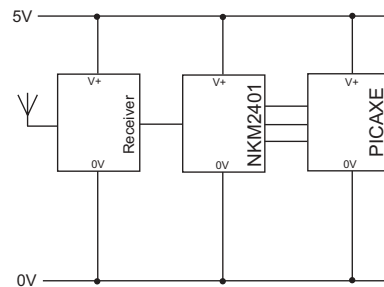

Example Wiring Connection:

The data pin of the receiver module (e.g. part RFA001) is connected to the input pin of the PICAXE chip.

Note that a suitable aerial (antenna) must be connected and that there must be at least 1m distance between transmitter and receiver.

Effect of increased clock speed:

This command only functions at 4MHz. M2 and X2 parts automatically use the internal 4MHz resonator for this command.

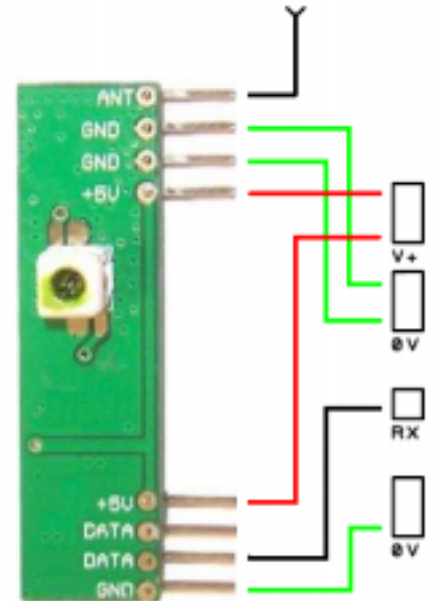
*Example:***main:**

```
    rfin C.0, b0,b1,b2,b3,b4,b5,b6,b7
```

```
    debug
```

```
    goto main
```

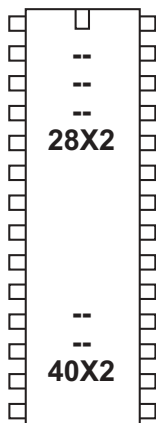
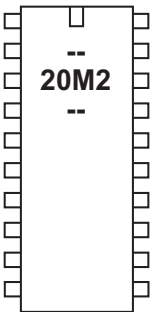
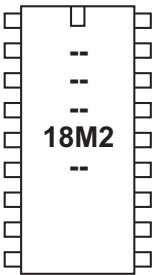
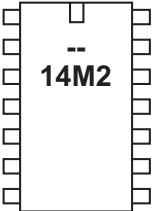
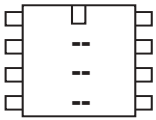

Firmware >= B.3

rfout

Syntax:

rfout pin, (data, data, data, data, data, data, data, data)

- pin is a variable/constant which specifies the i/o pin to use
- data is a constant/variable specifying the byte data

Function:

Send 8 bytes of Manchester encoded radio data to a NKM2401 decoder or a PICAXE rfin command over a wireless link. Note that the rfout command always sends 8 bytes of data, so exactly 8 data variables are required within this command syntax.

Information:

The rfout command encodes and transmits 8 bytes of data over a radio link to a NKM2401 decoder or another PICAXE chip. This provides much more reliable radio communication than using serout commands with low cost RF modules.

This command is equivalent to using an NKM2401 encoder to transmit the data. Therefore if using a PICAXE chip that does not support this command, simply use a NKM2401 encoder instead.

The NKM2401 encoder can be used with all PICAXE chips, even those that do not support the rfout command. For further details about how to use the NKM2401 decoder please see the AXE213 datasheet at:

www.rev-ed.co.uk/docs/axe213.pdf

This datasheet also explains in detail how to use low cost RF modules.

Using rfout command

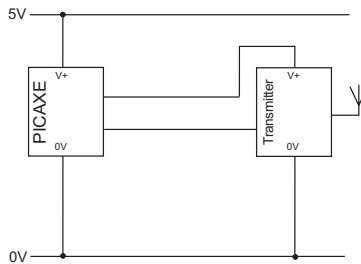

Using serout command with NKM2401

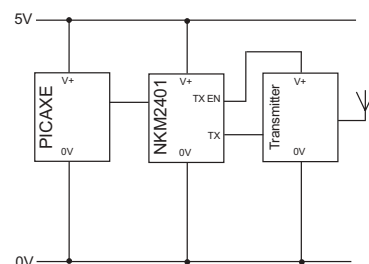

Example Wiring Connection:

The data pin of the transmitter module (e.g. part RFA001) is connected to the output pin (TX) of the PICAXE chip. A second output pin (TXEN) is also used to power on the transmitter when required. This circuit only supports transmitters that require under 20mA current, for higher power units use a transistor switching circuit to power the transmitter instead.

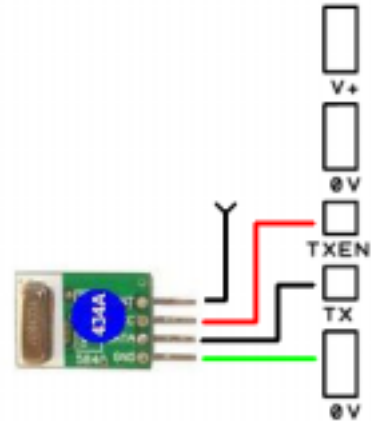

Do not leave the transmitter permanently powered.

Do not connect to the Darlington driver 'buffered' outputs on a project board, as the data signal must be connected directly to the PICAXE output pin.

Effect of increased clock speed:

This command only functions at 4MHz. M2 and X2 parts automatically use the internal 4MHz resonator for this command.

*Example:***main:**

```

readtemp C.1, b7      ; read temperature into variable b7
bintoascii b7,b8,b9,b10 ; separate into 3 ASCII characters
high b.1              ; switch radio module on (TXEN)
rfout b.0,("Temp=",b8,b9,b10) ; send data (TX)
low b.1              ; switch radio module off (TXEN)
pause 2000           ; wait 2 seconds
goto main            ; loop forever

```

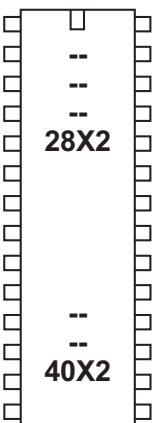
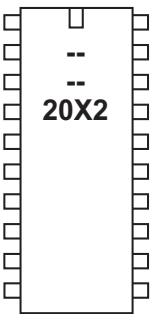
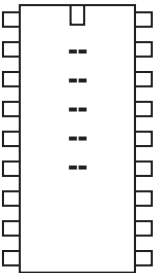
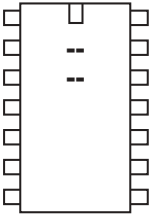
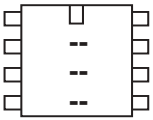

run

Syntax:

RUN slot

- slot is a variable/constant which specifies which program to run

Function:

Run another program slot.

Information:

The 28X2/40X2 parts have four completely separate internal program slots. By default program 0 runs whenever the part is reset. The 20X2 only supports slot 0.

A new program is downloaded into any slot via the #slot directive, which is added as a line to the program. It is only possible to download one program to one slot at a time. The other programs are not affected by the download.

To run the second program (after downloading with a #slot 1 directive) use the command 'run 1'. This command stops the current program and starts the second program running immediately. Variables and pin conditions are not reset, so can be shared between the programs. However all other system functions, such as the gosub/return stack, are reset when the second program starts. Therefore slot 1 program can only be considered as a 'goto' from the slot 0 program, not a 'gosub'.

When in program 1 you can also use 'run 0' to restart the first program. If you wish to also reset the variables you must use a 'reset' command instead to restart program 0. This is equivalent to 'run 0' + variable reset.

Note that when carrying out a new program download the download is into the first program slot by default. If you wish to download into the second program slot you must use the '#slot 1' directive within the program.

All X2 parts also support running programs from external i2c EEPROM chips. These are known as program slots 4 to 7 (on an EEPROM with address 000). As up to 8 possible external EEPROM addresses may be used, that gives a theoretical total of 32 (8x4) external programs. When using an EEPROM not at address 000, bits 7-5 of the slot number are used as the EEPROM address, e.g. for an EEPROM with address pins A2 low, A1 high and A0 high, running slot 5 would be

```
run %011xx101          (where x = 0 or 1, don't care)
```

When running a program from an external EEPROM chip certain restrictions apply:

- 1) the i2c SDA and SCL pins are reserved, and so the i2c bus cannot be used for other commands
- 2) program operation will be marginally slower, as retrieving data from an external EEPROM is slower than retrieving data from the internal program memory.

Also see the 'booti2c' command, which may be preferable to using slots 4-7.

Additional Information - Understanding Program Slots

The X2 range have up to 4 internal program slots, numbered 0 to 3. Each slot is completely independent of the other slots. When the microcontroller is reset the program in slot 0 automatically starts running. The other programs can then be started by using a 'run' command.

A new program download is, by default, into slot 0. To download into another program slot the #slot directive must be used in the program, e.g.

```
#slot 1
```

will download the program into slot 1 instead of slot 0. All other slots are unaffected.

Note that when the download is complete the program will always start running from slot 0, not the slot just downloaded. If you wish to instantly test, for instance, a program downloaded into slot 1, the command 'run 1' must have been previously downloaded into slot 0.

As the microcontroller only has one internal EEPROM data area (used by the EEPROM, read and write commands) any download into any internal memory slot will always update the same EEPROM memory. To disable this update it is possible to use a #no_data directive in the downloaded program. This prevents the EEPROM data area being updated (i.e. any EEPROM command data is ignored).

The usual way to make use of the program slots is to test an input (e.g. jumper link) upon reset, and then run the different program according to the input condition e.g.

```
#slot 0

if pinC.1 = 1 then
  run 1
endif
if pinC.2 = 1 then
  run 2
endif
```

However program slots can be combined into one 'long program' as long as the following points are noted:

- 1) No gosubs (including the interrupt) can be shared between program slots
- 2) The gosub/return stack is reset when moving from one slot to another
- 3) Outputs and variables/scratchpad are not reset
- 4) The 'run X' command should be regarded as 'goto to the start of program X'

Note that 'run 0' is not the same as the 'reset' command, as the reset command will also reset all variables and convert all pins back to inputs.

External Program Slots

As well as the internal memory slots, 4 additional slots can be used by connecting an external i2c EEPROM chip (part 24LC128). As up to 8 different 24LC128 chips could be used on the same I2C bus, this gives a theoretical 32 (8x4) additional program slots.

For an 24LC128 at address 0 (ie pins A0, A1, A2 all connected to 0V) the i2c program slots are simply numbered 4 to 7. For other 24LC128 addresses the run (and #slot) number must be calculated as follows

Bit7	24LC128 address pin A2
Bit6	24LC128 address pin A1
Bit5	24LC128 address pin A0
Bit4	<i>reserved for future use, use 0</i>
Bit3	<i>reserved for future use, use 0</i>
Bit2	1 = I2C, 0 = internal
Bit1, 0	4 possible slot numbers

Running a program from external i2c has some restrictions

- 1) The i2c bus is reserved exclusively for the program reading
- 2) The i2c pins cannot be used for any other purpose
- 3) Any hardware i2c/spi commands are completely ignored
- 4) Program execution speed is reduced, due to the relatively slow speed of reading data from the external 24LC128

The external 24LC128 only stores the program memory space. Any download data memory information (ie from the EEPROM command) is not stored externally. Read and write commands continue to act on the internal PICAXE EEPROM data memory space.

Example:

```
#slot 0
init:
    if pinC.1 =1 then main ' test an input pin upon reset
    run 1                  ' input is low so run slot 1 program

main: high B.1            ' this is normal program (slot 1)
etc...
```

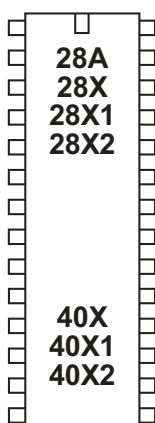
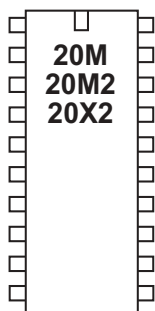
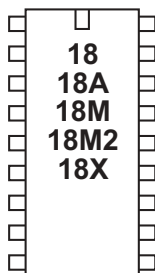
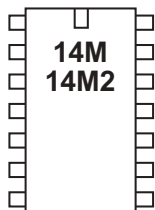
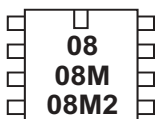

select case \ case \ else \ endselect

Syntax:

```

SELECT VAR
CASE VALUE
  {code}
CASE VALUE, VALUE..
  {code}
CASE VALUE TO VALUE
  {code}
CASE ?? value
  {code}
ELSE
  {code}
ENDSELECT

```

- Var is the value to test.

- Value is a variable/constant.

?? can be any of the following conditions

```

=      equal to
is     equal to
<>    not equal to
!=    not equal to
>     greater than
>=    greater than or equal to
<     less than
<=    less than or equal to

```

Function:

Compare a variable value and conditionally execute sections of code.

Information:

The multiple select \ case \ else \ endselect command is used to test a variable for certain conditions. If these conditions are met that section of the program code is executed, and then program flow jumps to the endselect position. If the condition is not met program flow jumps directly to the next case or else command.

The 'else' section of code is only executed if none of the case conditions have been true.

Example:

```

select case b1
case 1
  high 1
case 2,3
  low 1
case 4 to 6
  high 2
else
  low 2
endselect

```

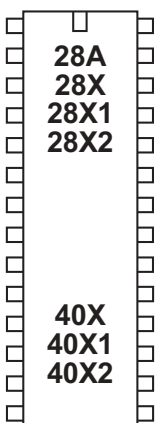
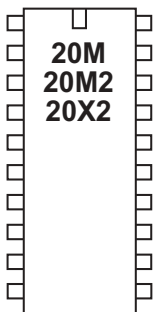
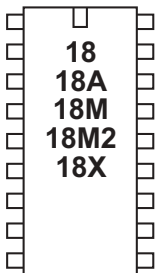
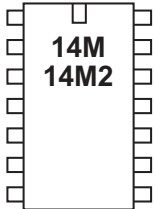
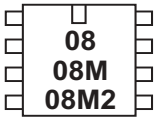

serin

Syntax:

```

SERIN pin,baudmode,(qualifier,qualifier...)
SERIN pin,baudmode,(qualifier,qualifier...),{#}variable,{#}variable...
SERIN pin,baudmode,{#}variable,{#}variable...
    
```

Additional optional timeout syntax options for M2, X1 and X2 parts:

```

SERIN [timeout], pin,baudmode,(qualifier...)
SERIN [timeout], pin,baudmode,(qualifier...),{#}variable,{#}variable
SERIN [timeout], pin,baudmode,{#}variable,{#}variable
SERIN [timeout,address], pin,baudmode,(qualifier...)
SERIN [timeout,address], pin,baudmode,(qualifier...),{#}variable,{#}variable
SERIN [timeout,address], pin,baudmode,{#}variable,{#}variable
    
```

- Pin is a variable/constant which specifies the i/o pin to use.
- Baudmode is a variable/constant (0-7) which specifies the mode:

Txxx give a true output (idle high)
Nxxx give an inverted output (idle low)

for older 08 / 08M / 18 / 18A / 28 / 28A parts

4MHz	8MHz	16MHz
T300_4	T600_8	T1200_16
T600_4	T1200_8	T2400_16
T1200_4	T2400_8	T4800_16
T2400_4	T4800_8	T9600_16
N300_4	N600_8	N1200_16
N600_4	N1200_8	N2400_16
N1200_4	N2400_8	N4800_16
N2400_4	N4800_8	N9600_16

for all other parts (e.g. all X1, X2, M2 parts)

4MHz	8MHz	16MHz
T600_4	T1200_8	T2400_16
T1200_4	T2400_8	T4800_16
T2400_4	T4800_8	T9600_16
T4800_4	T9600_8	T19200_16
N600_4	N1200_8	N2400_16
N1200_4	N2400_8	N4800_16
N2400_4	N4800_8	N9600_16
N4800_4	N9600_8	N19200_16
32MHz	64MHz	
T4800_32	T9600_64	
T9600_32	T19200_64	
T19200_32	T38400_64	
T38400_32	T76800_64	
N4800_32	N9600_64	
N9600_32	N19200_64	
N19200_32	N38400_64	
N38400_32	N76800_64	

- Qualifiers are optional variables/constants (0-255) which must be received in exact order before subsequent bytes can be received and stored in variables.
- Variable(s) receive the result(s) (0-255). Optional #'s are for inputting ASCII decimal numbers into variables, rather than raw characters.
- Timeout is an optional variables/constants which sets the timeout period in milliseconds
- Address is a label which specifies where to go if a timeout occurs.

Function:

Serial input with optional qualifiers (8 data, no parity, 1 stop).

Information:

The serin command is used to receive serial data into an input pin of the microcontroller. It cannot be used with the serial download input pin, which requires use of the serrxd command instead.

Pin specifies the input pin to be used. Baud mode specifies the baud rate and polarity of the signal. When using simple resistor interface, use N (inverted) signals. When using a MAX232 type interface use T (true) signals. The protocol is fixed at N,8,1 (no parity, 8 data bits, 1 stop bit).

Note that the 4800 baud rate is available on the M, X, X1 and X2 parts. Note that the microcontroller may not be able to keep up with processing complicated datagrams at higher speeds - in this case it is recommended that the transmitting device leaves a short delay (e.g. 2ms) between each byte.

Qualifiers are used to specify a 'marker' byte or sequence. The command

```
serin 1,N2400, ("ABC"), b1
```

requires to receive the string "ABC" before the next byte read is put into byte b1

Without qualifiers

```
serin 1,N2400,b1
```

the first byte received will be put into b1 regardless.

All processing stops until the new serial data byte is received. This command cannot be interrupted by the setint command. The following example simply waits until the sequence "go" is received.

```
serin 1,N2400, ("go")
```

IMPORTANT!

It is a very common mistake to accidentally use a qualifier by mistake like this:

```
serin 1,N2400, (b1)
```

If you do not want a qualifier do not use brackets!

```
serin 1,N2400, b1
```

The M2, X1 and X2 parts can take an optional timeout value and address at the start of the command. The timeout value, set in milliseconds, is the length of time the serin command will wait for a serial command to be detected. After the timeout period, if no signal is detected, program flow will jump to the time out address.

After using this command you may have to perform a 'hard reset' to download a new program to the microcontroller. See the Serial Download section for more details.

A maximum of 4800 baud is recommended for complicated serial transactions at 8MHz. Internal resonators are not as accurate as external resonators, so in high accuracy applications an external resonator device is recommended. However microcontrollers with an internal resonator may be used successfully in most applications, and may also be calibrated using the calibfreq command if required.

Example Computer Interface Circuit:

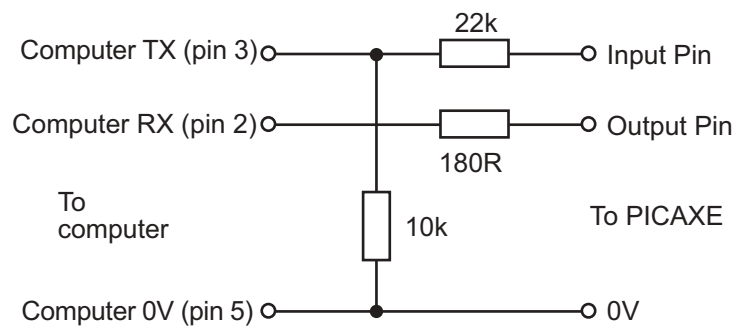

All 8 and 14 pin - Due to the internal structure of input3 (C.3) on these chips, a 1N4148 diode is required between the pin and V+ for serin to work on this particular pin ('bar' end of diode to V+) with this circuit. All other pins have an internal diode.

All 20 pin - Due to the internal structure of input6 (C.6) on this chip, a 1N4148 diode is required between the pin and V+ for serin to work on this particular pin ('bar' end of diode to V+) with this circuit. All other pins have an internal diode.

Example:

```
main: for b0 = 0 to 63      ; start a loop
      serin 6,N2400,b1    ; receive serial value
      write b0,b1        ; write value into b1
next b0                    ; next loop
```

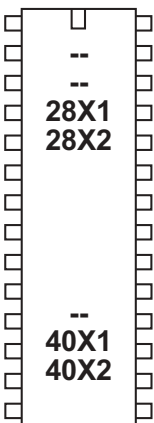
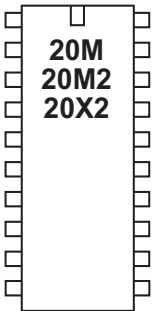
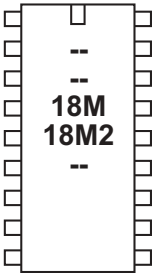
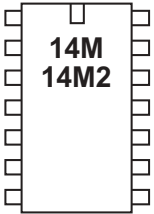
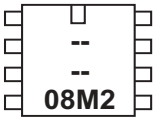

serrxd

Syntax:

SERRXD (qualifier, qualifier...)
SERRXD (qualifier, qualifier...), {#} variable, {#} variable...
SERRXD {#} variable, {#} variable...

Additional optional timeout syntax options for M2, X1 and X2 parts:

SERRXD [timeout], (qualifier...)
SERRXD [timeout], (qualifier...), {#} variable, {#} variable
SERRXD [timeout], {#} variable, {#} variable
SERRXD [timeout, address], (qualifier...)
SERRXD [timeout, address], (qualifier...), {#} variable, {#} variable
SERRXD [timeout, address], {#} variable, {#} variable

- Qualifiers are optional variables/constants (0-255) which must be received in exact order before subsequent bytes can be received and stored in variables.
- Variable(s) receive the result(s) (0-255). Optional #'s are for inputting ASCII decimal numbers into variables, rather than raw characters.
- Timeout is an optional variables/constants which sets the timeout period in milliseconds (not available on M parts).
- Address is a label which specifies where to go if a timeout occurs.

Function:

Serial input via the serial input programming pin (at fixed baud rate 4800 (9600 on X2 parts), 8 data, no parity, 1 stop).

Information:

The serrxd command is similar to the serin command, but acts via the serial input pin rather than a general input pin. This allows data to be received from the computer via the programming cable.

The PICAXE chip normally constantly scans the serial download pin to see if a computer is trying to initialise a new program download. However when it is desired to use serrxd it is necessary to disable this scanning. This is automatic, and is effectively the same as issuing a 'disconnect' command.

After disconnect is used it will not be possible to download a new program until:

- 1) the reconnect command is issued
- 2) a reset command is issued
- 3) a hardware reset is carried out

Remember that it is always possible to carry out a new download by carrying out the 'hard-reset' procedure (described in the PICAXE manual part 1).

Effect of Increased Clock Speed:

Increasing the clock speed increases the serial baud rate as shown below.

4MHz	8MHz	16MHz	32MHz
4800	9600	19200	38400

Example:

```
disconnect
serrxd [1000, timeout], @ptrinc, @ptrinc, @ptr
reconnect
```

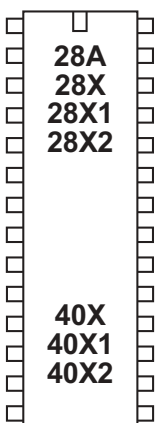
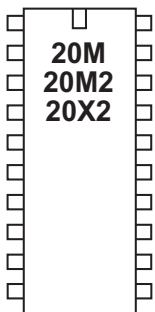
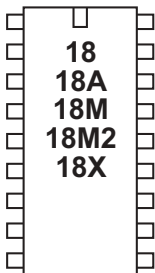
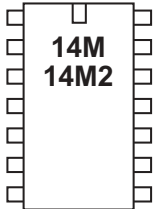
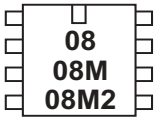

serout



Syntax:

SEROUT pin, baudmode, ({#} data, {#} data...)

- Pin is a variable/constant which specifies the i/o pin to use.
- Baudmode is a variable/constant (0-7) which specifies the mode:

Txxx give a true output (idle high)

Nxxx give an inverted output (idle low)

for 08 / 08M / 18 / 18A / 28 / 28A parts

4MHz	8MHz	16MHz
T300_4	T600_8	T1200_16
T600_4	T1200_8	T2400_16
T1200_4	T2400_8	T4800_16
T2400_4	T4800_8	T9600_16
N300_4	N600_8	N1200_16
N600_4	N1200_8	N2400_16
N1200_4	N2400_8	N4800_16
N2400_4	N4800_8	N9600_16

for all other parts (e.g. all X1, X2, M2 parts)

4MHz	8MHz	16MHz
T600_4	T1200_8	T2400_16
T1200_4	T2400_8	T4800_16
T2400_4	T4800_8	T9600_16
T4800_4	T9600_8	T19200_16
N600_4	N1200_8	N2400_16
N1200_4	N2400_8	N4800_16
N2400_4	N4800_8	N9600_16
N4800_4	N9600_8	N19200_16
32MHz	64MHz	
T4800_32	T9600_64	
T9600_32	T19200_64	
T19200_32	T38400_64	
T38400_32	T76800_64	
N4800_32	N9600_64	
N9600_32	N19200_64	
N19200_32	N38400_64	
N38400_32	N76800_64	

- Data are variables/constants (0-255) which provide the data to be output. Optional #'s are for outputting ASCII decimal numbers, rather than raw characters. Text can be enclosed in speech marks ("Hello")

Function:

Transmit serial data output (8 data bits, no parity, 1 stop bit).

Information:

The serout command is used to transmit serial data from an output pin of the microcontroller. It cannot be used with the serial download output pin - use the sertxd command in this case.

Pin specifies the output pin to be used. Baud mode specifies the baud rate and polarity of the signal. When using simple resistor interface, use N (inverted) signals. When using a MAX232 type interface use T (true) signals. The protocol is fixed at N,8,1 (no parity, 8 data bits, 1 stop bit).

A 'N' baud rate idles low, with data pulse going high.

A 'T' baud rate idles high, with data pulses going low. When using a T baud rate the very first byte may become corrupt if the output pin was low before the serout command (the pin will be automatically left high after the serout command). To avoid this issue place the line high (via a 'high' command) a few milliseconds before the very first serout command.

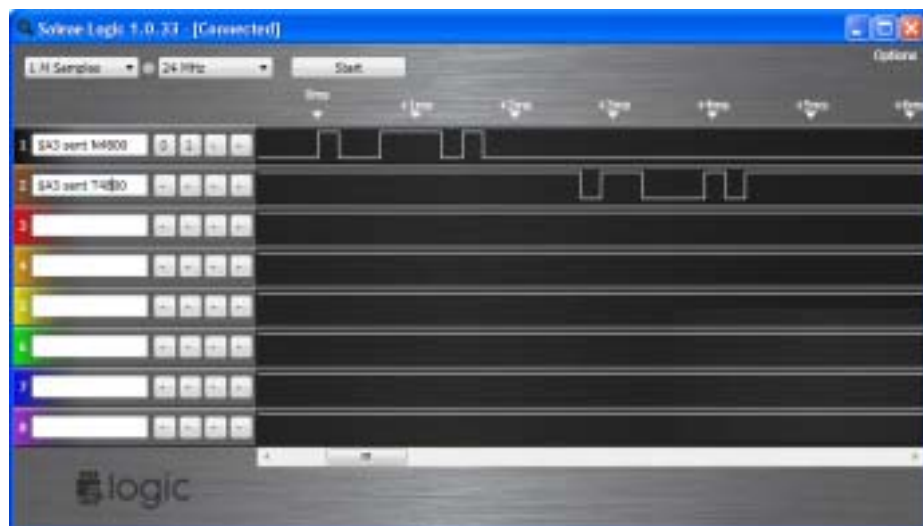

The # symbol allows ASCII output. Therefore #b1, when b1 contains the data 126, will output the ascii characters "1" "2" "6" rather than the raw data 126.

Please also see the interfacing circuits, affect of resonator clock speed, and explanation notes of the 'serin' command, as all of these notes also apply to the serout command.

*Example:***main:**

```

for b0 = 0 to 63           ; start a loop
  read b0,b1              ; read value into b1
  serout 7,N2400,(b1)     ; transmit value to serial LCD
next b0                   ; next loop

```

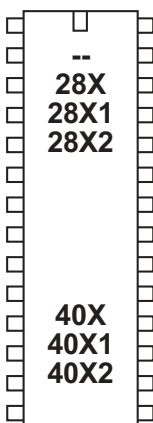
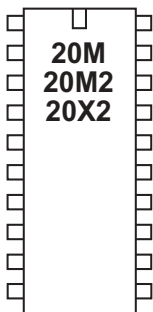
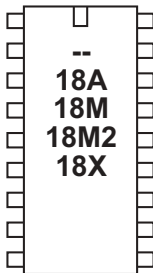
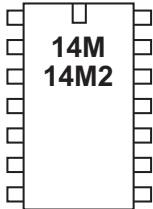
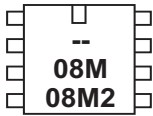

sertxd

Syntax:

SERTXD ({#} data,{#} data...)

- Data are variables/constants (0-255) which provide the data to be output.

Function:

Serial output via the serout programming pin (baud 4800, 8 data, no parity, 1 stop).

Information:

The sertxd command is similar to the serout command, but acts via the serial output pin rather than a general output pin. This allows data to be sent back to the computer via the programming cable. This can be useful whilst debugging data - view the uploaded data in the PICAXE>Terminal window. There is an option within View>Options>Options to automatically open the Terminal windows after a download.

The baud rate is fixed at 4800,n,8,1 (9600,n,8,1 on X2 parts)

Effect of Increased Clock Speed:

Increasing the clock speed increases the serial baud rate as shown below.

4MHz	8MHz	16MHz	32MHz	64MHz
4800	9600	19200	38400	76800

Example:

```
main:
    for b1 = 0 to 63      ; start a loop
        sertxd("The value of b1 is ",#b1,13,10)
        pause 1000
    next b1              ; next loop
```

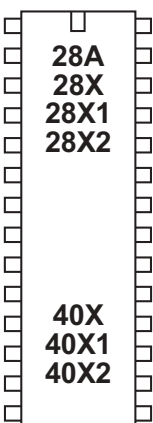
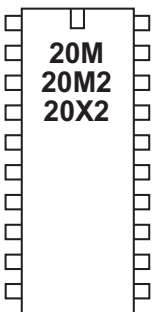
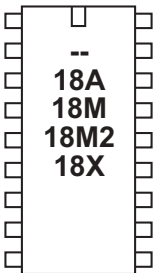
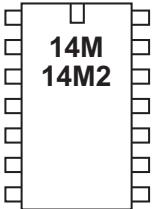
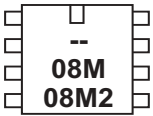

servo

Syntax:

SERVO pin,pulse

SERVO [preload],pin,pulse (X2 only)

- Pin is a variable/constant which specifies the i/o pin to use.
- Pulse is variable/constant (75-225) which specifies the servo position
- Preload is an optional timing constant (X2 parts only).

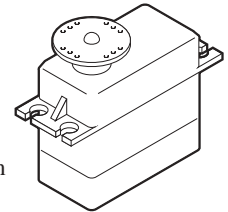

Function:

Pulse an output pin continuously to drive a radio-control style servo.

On M2 and X2 parts the servo commands only function on portB (B.0 to B.7)

Information:

Servos, as commonly found in radio control toys, are a very accurate motor/gearbox assembly that can be repeatedly moved to the same position due to their internal position sensor. Generally servos require a pulse of 0.75 to 2.25ms every 20ms, and this pulse must be constantly repeated every 20ms. Once the pulse is lost the servo will lose its position. The servo command starts a pin pulsing high for length of time pulse (x0.01 ms) every 20ms. This command is **different** to most other BASIC commands in that the pulsing mode **continues** until another servo, high or low command is executed. High and low commands stop the pulsing immediately. Servo commands adjust the pulse length to the new pulse value, hence moving the servo. Servo cannot be used at the same time as timer or pwmout/hpwm as they share a common internal timer resource.

The 'servo' command initialises the pin for servo operation and starts the timer. Once a pin has been initialised, it is recommended to use the 'servopos' command to adjust position. This prevents resetting of the timer, which could cause 'jitter'

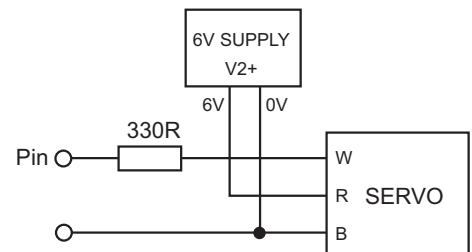

Do not generally use a pulse value less than 75 or greater than 225, as this may cause the servo to malfunction. Due to tolerances in servo manufacture all values are approximate and will require fine-tuning by experimentation (e.g. 60 to 200). Always use a separate 6V (e.g. 4x AA cells) power supply for the servo, as they generate a lot of electrical noise. Note that the overhead processing time required for processing the servo commands every 20ms causes the other commands to be slightly extended i.e. a pause command will take slightly longer than expected. The servo pulses are also temporarily disabled during timing sensitive commands like serin, serout, sertxd, debug etc.

On X2 parts servo will only function at 8MHz or 32MHz.

On M2 and X1 parts servo will only function at 4MHz or 16MHz.

On all other parts servo will only function at 4MHz.

On X2 parts it is possible to change the 20ms delay between pulses. This is achieved via the 'preload' value, which is the number to preload into timer 1 before it starts counting. On X2 parts timer 1 increments every 0.5us, so for a delay of 20ms (20,000us) we need 40,000 increments. Therefore the preload value is $65,536 - 40,000 = 25,536$.

As an example, for digital servos, you may wish to increase the pulse frequency to every 10ms (note the delay must be longer than the total of all pulses to all servos, so 10ms is only suitable for up to 4 servos (maximum delay for 4 servos is when pulse length is 2.25ms, so $4 \times 2.25 = 9\text{ms}$).

$$10\text{ms} = 10,000 \text{ us} = 20,000 \text{ steps}$$
$$65536 - 20,000 = 45536$$

So the command is

```
servo [45536],1,75
```

Effect of increased clock speed:

The servo command will function correctly at 4MHz on all parts (except X2 parts, which only function at 8 or 32MHz). 16MHz is also additionally supported on M2 and X1 parts. No other frequency will work correctly.

Example:

```
init: servo 4,75           ; initialise servo  
main: servopos 4,75      ; move servo to one end  
      pause 2000         ; wait 2 seconds  
      servopos 4,225     ; move servo to other end  
      pause 2000         ; wait 2 seconds  
      goto main          ; loop back to start
```

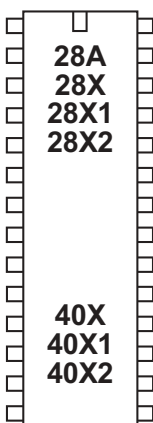
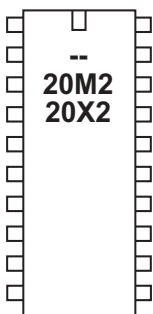
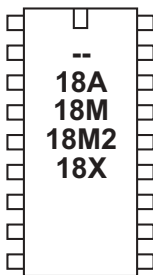
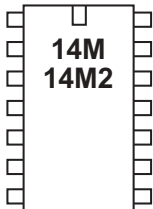
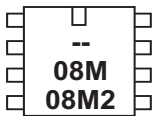

servopos

Syntax:

SERVOPOS pin,pulse

SERVOPOS pin,OFF

- Pin is a constant which specifies the i/o pin to use.

- Pulse is variable/constant (75-225) which specifies the servo position

Function:

Adjust the pulse length applied to a radio-control style servo to change its position. A servo command on the same pin number must have been previously issued.

Information:

Servos, as commonly found in radio control toys, are a very accurate motor/gearbox assembly that can be repeatedly moved to the same position due to their internal position sensor. Generally servos require a pulse of 0.75 to 2.25ms every 20ms, and this pulse must be constantly repeated every 20ms. Once the pulse is lost the servo will lose its position. The 'servo' command starts a pin pulsing high for length of time pulse (x0.01 ms) every 20ms. The 'servopos' adjusts the length of this pulse.

The 'servo' command initialises the pin for servo operation and starts the timer. Once a pin has been initialised, it is recommended to use the 'servopos' command to adjust position. This prevents resetting of the timer, which could cause 'jitter'

Do not use a pulse value less than 75 or greater than 225, as this may cause the servo to malfunction. Due to tolerances in servo manufacture all values are approximate and will require fine-tuning by experimentation. Always use a separate 6V (e.g 4x AA cells) power supply for the servo, as they generate a lot of electrical noise. Note that the overhead processing time required for processing the servo commands every 20ms causes the other commands to be slightly extended i.e. a pause command will take slightly longer than expected. The servo pulses are also temporarily disabled during timing sensitive serin, serout, sertxd and debug commands.

Effect of increased clock speed:

The servo command will function correctly at	4 or 16MHz	(M2/X1 parts)
	8 or 32Mhz	(X2 parts)
	4MHz	(all other)

No other frequency will work correctly.

Example:

```
init: servo B.4,75      ; initialise servo
main: servopos B.4,75  ; move servo to one end
      pause 2000       ; wait 2 seconds
      servopos B.4,225 ; move servo to other end
      pause 2000       ; wait 2 seconds
      goto main        ; loop back to start
```

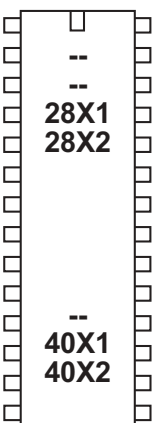
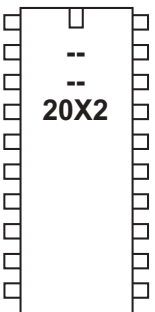
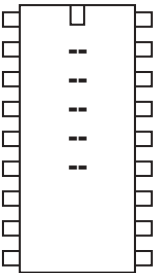
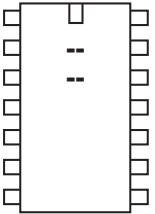
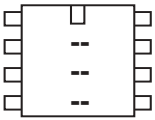

setbit

Syntax:

SETBIT var, bit

- var is the target variable.
- bit is the target bit (0-7 for byte variables, 0-15 for word variables)

Function:

Set a specific bit in the variable.

Information:

This command sets (sets to 1) a specific bit in the target variable.

Example:

```
setbit b6, 0
setbit w4, 15
```

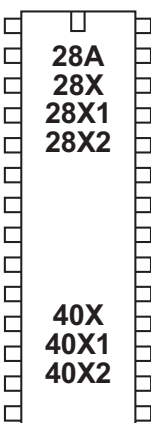
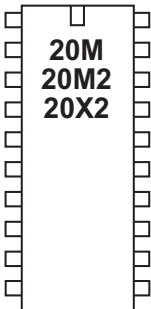
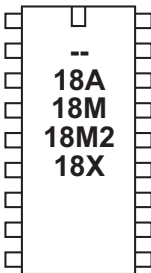
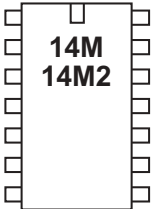
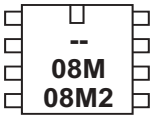

setint



Syntax:

SETINT OFF
SETINT input,mask (AND condition)
SETINT AND input,mask (AND condition)

Additional options for M2, X1 and X2 parts:

SETINT OR input,mask (OR Condition)
SETINT NOT input,mask (NOT the AND Condition)

Additional options for X2 parts:

SETINT input,mask,port
SETINT NOT input,mask,port

- input is a variable/constant (0-255) which specifies input condition.
- mask is variable/constant (0-255) which specifies the mask
- port is the X2 port (A,B,C,D)

Function:

Interrupt on a certain inputs condition.

X1 and X2 parts can also alternately interrupt on a certain 'flags' byte condition - see setintflags command.

Information:

The setint command causes a polled interrupt on a certain input pin condition. This can be a combination of pins on the default input port (portC). X2 parts can also be redirected to look at a different port if required.

The default condition is a logical AND of the selected input pins.

On some parts it is also possible to take the NOT of this AND condition.

On some parts it is also possible to take a logical OR of the selected input pins.

A polled interrupt is a quicker way of reacting to a particular input combination. It is the only type of interrupt available in the PICAXE system. The inputs port is checked between execution of each command line in the program, between each note of a tune command, and continuously during any pause command. If the particular inputs condition is true, a 'gosub' to the interrupt sub-procedure is executed immediately. When the sub-procedure has been carried out, program execution continues from the main program.

The interrupt inputs condition is any pattern of '0's and '1's on the input port, masked by the byte 'mask'. Therefore any bits masked by a '0' in byte mask will be ignored.

to interrupt on input1 high only

```
setint %00000010,%00000010
```

to interrupt on input1 low only

```
setint %00000000,%00000010
```

to interrupt on input0 high, input1 high and input 2 low

```
setint %00000011,%00000111
```

etc.

Only one input pattern is allowed at any time. To disable the interrupt execute a SETINT OFF command. The M2, X1, X2 parts also support the NOT condition, where the interrupt occurs when the pattern is NOT as the port/mask define.. They can also use the 'flags' byte (instead of the input port) to generate the interrupt condition.

Restrictions.

Due to internal port configuration on some of the chips there is a limitation on which pins can be used. The default input port is portC.

14M/14M2	only inputs 0,1,2 may be used
20M	only inputs 1-5 may be used
20M2/20X2	only portC may be used, and only C.1 to C.5 on portC
40X2	when using portA, only A.0 to A.3 may be used

Notes:

- 1) Every program which uses the SETINT command must have a corresponding interrupt: sub-procedure (terminated with a return command) at the bottom of the program.
- 2) When the interrupt occurs, the interrupt is permanently disabled. Therefore to re-enable the interrupt (if desired) a SETINT command must be used within the interrupt: sub-procedure itself. The interrupt will not be enabled until the 'return' command is executed.
- 3) If the interrupt is re-enabled and the interrupt condition is not cleared within the sub-procedure, a second interrupt may occur immediately upon the return command.
- 4) After the interrupt code has executed, program execution continues at the next program line in the main program. In the case of the interrupted pause, wait, play or tune command, any remaining time delay is ignored and the program continues with the next program line.

More detailed SETINT explanation.

The SETINT must be followed by two numbers - a 'compare with value' (input) and an 'input mask' (mask) in that order. It is normal to display these numbers in binary format, as it makes it more clear which pins are 'active'. In binary format input7 is on the left and input0 is on the right.

The second number, the 'input mask', defines which pins are to be checked to see if an interrupt is to be generated ...

- %00000001 will check input pin 0
- %00000010 will check input pin 1
- %01000000 will check input pin 6
- %10000000 will check input pin 7
- etc

These can also be combined to check a number of input pins at the same time...

- %00000011 will check input pins 1 and 0
- %10000100 will check input pins 7 and 2

Having decided which pins you want to use for the interrupt, the first number (inputs value) states whether you want the interrupt to occur when those particular inputs are on (1) or off (0).

Once a SETINT is active, the PICAXE monitors the pins you have specified in 'input mask' where a '1' is present, ignoring the other pins.

An input mask of %10000100 will check pins 7 and 2 and create a value of %a0000b00 where bit 'a' will be 1 if pin 7 is high and 0 if low, and bit 'b' will be 1 if pin 2 is high and 0 if low.

The 'compare with value', the first argument of the SETINT command, is what this created value is compared with, and if the two match, then the interrupt will occur, if they don't match then the interrupt won't occur.

If the 'input mask' is %10000100, pins 7 and 2, then the valid 'compare with value' can be one of the following ...

- %00000000 Pin 7 = 0 and pin 2 = 0
- %00000100 Pin 7 = 0 and pin 2 = 1
- %10000000 Pin 7 = 1 and pin 2 = 0
- %10000100 Pin 7 = 1 and pin 2 = 1

So, if you want to generate an interrupt whenever Pin 7 is high and Pin 2 is low, the 'input mask' is %10000100 and the 'compare with value' is %10000000, giving a SETINT command of ...

```
- SETINT %10000000,%10000100
```

The interrupt will then occur when, and only when, pin 7 is high and pin 2 is low. If pin 7 is low or pin 2 is high the interrupt will not happen as two pins are 'looked at' in the mask.

Example:

```
setint %10000000,%10000000
; activate interrupt when pin7 only goes high
```

main:

```
low 1 ; switch output 1 off
pause 2000 ; wait 2 seconds
goto main ; loop back to start
```

interrupt:

```
high 1 ; switch output 1 on
if pin7 = 1 then interrupt ; loop here until the
; interrupt cleared
pause 2000 ; wait 2 seconds
setint %10000000,%10000000 ; re-activate interrupt
return ; return from sub
```

In this example an LED on output 1 will light immediately the input is switched high. With a standard if pin7 =1 then.... type statement the program could take up to two seconds to light the LED as the if statement is not processed during the pause 2000 delay time in the main program loop (standard program shown below for comparison).

main:

```
low 1                ; switch output 1 off
pause 2000           ; wait 2 seconds
if pin7 = 1 then sw_on
goto main           ; loop back to start
```

sw_on:

```
high 1              ; switch output 1 on
if pin7 = 1 then sw_on
                    ; loop here until the condition is cleared
pause 2000          ; wait 2 seconds
goto main           ; back to main loop
```

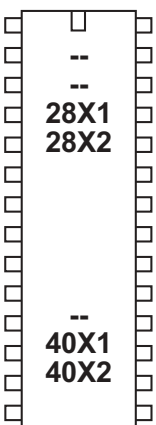
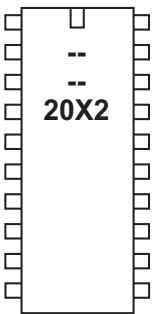
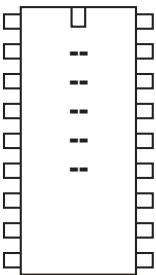
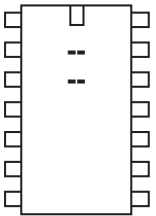
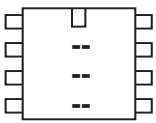

setintflags

Syntax:

- SETINTFLAGS OFF**
- SETINTFLAGS flags,mask**
- SETINTFLAGS AND flags,mask**
- SETINTFLAGS OR flags,mask**
- SETINTFLAGS NOT flags,mask**

- flags is a variable/constant (0-255) which specifies flags byte condition.
- mask is variable/constant (0-255) which specifies the mask

Function:

Interrupt on a certain 'flags' byte condition.

Please also see the detailed usage notes under the 'setint' command, which also apply to the 'setintflags' command. Only one interrupt can be active at any time.

Information:

The setintflags command causes a polled interrupt on a certain flags condition. A polled interrupt is a quicker way of reacting to a particular event. It is the only type of interrupt available in the PICAXE system. The flags byte is checked between execution of each command line in the program, between each note of a tune command, and continuously during any pause command. If the particular inputs condition is true, a 'gosub' to the interrupt sub-procedure is executed immediately. When the sub-procedure has been carried out, program execution continues from the main program.

The interrupt inputs condition is any pattern of '0's and '1's on the flags byte masked by the byte 'mask'. Therefore any bits masked by a '0' in byte mask will be ignored.

The system 'flags' byte is broken down into individual bit variables. See the appropriate command for more specific details about each flag.

Name	Special function	Command
flag0 hint0flag	X2 parts - interrupt on INT0	hintsetup
flag1 hint1flag	X2 parts - interrupt on INT1	hintsetup
flag2 hint2flag	X2 parts - interrupt on INT2	hintsetup
flag3 hintflag	X2 parts - interrupt on any pin 0,1,2	hintsetup
flag4 compflag	X2 parts - comparator flag	compsetup
flag5 hserflag	hserial background receive has occurred	hsersetup
flag6 hi2cflag	hi2c write has occurred (slave mode)	hi2csetup
flag7 toflag	timer overflow flag	settimer

to interrupt on timer 0 overflow

```
setintflags %10000000,%10000000
```

to interrupt on hi2c write (slave mode)

```
setintflags %01000000,%01000000
```

to interrupt on background hardware serial receive

```
setintflags %00100000,%00100000
```

Only one input pattern is allowed at any time. To disable the interrupt execute a 'setintflags off' command.

For more information about the various setintflags options (AND / OR / NOT) please see the setint command.

Example:

```
setintflags %10000000,%10000000 ;set timer 0 to interrupt
```

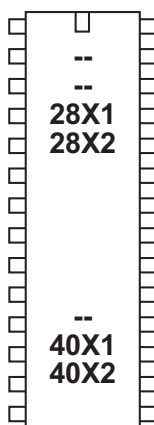
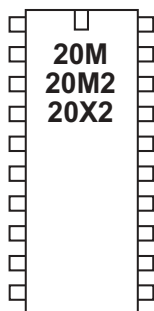
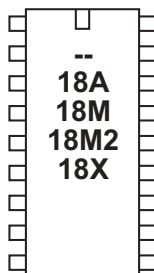
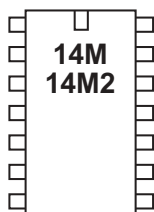
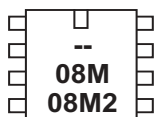

setfreq

Syntax:

setfreq freq

- freq is the keyword that selects the appropriate frequency

08M, 14M, 20M	internal	m4, m8
18A, 18M, 18X	internal	m4, m8
All M2 parts	internal	k31, k250, k500, m1, m2, m4, m8, m16, m32
20X2	internal	k31, k250, k500, m1, m2, m4, m8, m16, m32, m64
28X1, 40X1	internal	k31, k125, k250, k500, m1, m2, m4, m8
	external	em4, em8, em10, em16, em20
28X2, 40X2	internal	k31, k250, k500, m1, m2, m4, m8, m16
	external	em16, em32, em40, em64
28X2-5V, 40X2-5V	internal	k31, k250, k500, m1, m2, m4, m8
	external	em16, em32, em40
28X2-3V, 40X2-3V	internal	k31, k250, k500, m1, m2, m4, m8, m16
	external	em16, em32, em40, em64

where	k31	=	31kHz internal resonator
	m4	=	4MHz internal resonator
	em16	=	16MHz external resonator etc.

Function:

Set the internal clock frequency for microcontrollers with internal resonator to 8MHz (m8) or some other value.

The default value on X2 parts is 8MHz internal. The default value on all other parts is 4MHz internal.

Information:

The setfreq command can be used to change the speed of operation of the microcontroller from 4MHz to 8MHz (or some other value). However note that this speed increase affects many commands, by, for instance, changing their properties (e.g. all pause commands are half the length at 8MHz).

Note that the X2 parts have an internal x4 PLL inside the chip. This multiplies the external resonator speed by 4. Therefore the external resonator value to be used is 1/4 of the desired final speed (ie in mode em40 use an external 10MHz resonator, for em16 use a 4MHz resonator).

The change occurs immediately. All programs default to m4 (4MHz) if a setfreq command is not used (default is increased to m8, 8MHz on X2 parts).

Note that the Programming Editor only supports certain frequencies for new program downloads. If your chip is running at a different frequency the M2, X1 and X2 parts will automatically switch back to internal 4MHz / 8MHz default speed to complete the download.

On M2 'multi-tasking' programs the setfreq command may not be used, as the oscillator speed is under control of the PICAXE firmware for task processing.

The internal resonator frequencies are factory preset to the most accurate settings. However advanced users may use the calibfreq command to adjust these factory preset settings.

Some commands such as readtemp will only work at 4MHz. In these cases change back to 4MHz temporarily to operate these commands (on M2, X1 and X2 parts this is automatic).

Note that a temporary change in frequency (either programmed or automatic) will have a direct effect on background frequency dependant tasks such as pwmout / hpwm.

Example:

```
setfreq em32      ; setfreq to external 32MHz
pause 4000        ; NB not 4 seconds as overclocked
setfreq m4        ; setfreq to 4MHz
readtemp 1,b1     ; do command at 4MHz
setfreq em32      ; set freq back to 32MHz
```

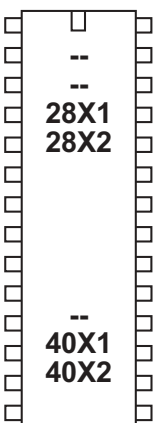
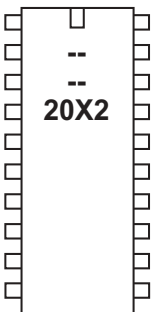
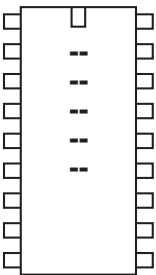
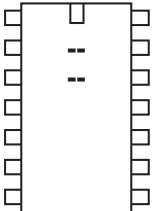
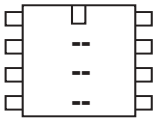

settimer

Syntax:

SETTIMER OFF

SETTIMER preload

SETTIMER COUNT preload

- preload is the constant/variable that selects the appropriate timing. For convenience timer 1s value constants are predefined in the compiler.

t1s_4	(preload value 49910 - 1 second at 4MHz)
t1s_8	(preload value 34286 - 1 second at 8MHz)
t1s_16	(preload value 3036 - 1 second at 16MHz)

Function:

Configure and start the internal timer / counter.

Information:

The settimer command is used to configure the hardware timer / counter function. The timer function can be used in two way - as an internal timer or as an external counter (input 0 (C.0) only).

Note that the 'debug' command temporarily disables the timer (during the actual variables transmission). Therefore use of the debug command at the same time as the timer will cause false readings.

External Counter (not available on 20X2)

In external counter mode an internal counter register (not accessible to the end user) is incremented on every positive going edge detected on input 0. This pulse counting occurs in the background, so the PICAXE program can perform other tasks at the same time as it is counting (unlike the count command, which stops other processing during the count command time period). When the internal counter register overflows from 65535 to 0, the special 'timer' variable is automatically incremented.

Therefore to increment the timer variable on every 10 external pulses set the preload value to 65536 - 10 = 65526. After ten pulses the counter register will overflow and hence increment the 'timer' variable. To increment the 'timer' variable on every external pulse simply set the preload value to 65535.

If the timer word variable overflows (ie from 65535 to 0) the timer overflow flag (toflag) is set. The toflag is automatically cleared upon the settimer command, but can also be cleared manually in software via 'let toflag = 0'. If desired an interrupt can be set to detect this overflow by use of the setintflags command.

Example:

```

settimer count 65535      ' settimer to count mode
main:
pause 10000              ' wait 10 seconds, counting pulses
debug                    ' display timer value
goto main                ' loop
  
```

Internal Timer

In internal timer mode the time elapsed is stored in the word variable 'timer' which can be accessed as if was a normal variable e.g.

```
if timer > 200 then skip
```

When the timer word variable overflows (ie from 65535 to 0) the timer overflow flag (toflag) is set. The toflag is automatically cleared upon the settimer command, but can also be cleared manually via 'let toflag = 0'. If desired an interrupt can be set to detect this overflow by use of the setintflags command.

The period of the timer can be used defined. The timer operates with 'minor ticks' and 'major ticks'. A minor tick occurs every $1/(\text{clock freq} / 256)$ seconds. With a 4MHz resonator this means a minor tick occurs every 64us (32us at 8MHz, 16us at 16MHz, 8us at 32MHz, 4us at 64MHz). When the minor tick word variable (not accessible by the end user) overflows (from 65535 to 0) a major tick occurs. The major tick increments the timer variable, and so the number of major ticks passed can be determined by reading the 'timer' variable.

The preload value is used to preload the minor tick variable after it overflows. This means it is not always necessary to wait the full 65536 minor ticks, for instance, if the preload value is set to 60000 you then only have to wait 5536 minor ticks before the major tick occurs.

As an example, assume you wish the timer to increment every second at 4MHz. We know that at 4MHz each minor tick takes 64us and 1 second is equivalent to 1000000 us. Therefore we require 15625 ($1000000 / 64$) minor ticks to give us a 1 second delay. Finally $65536 - 15625 = 49910$, so our preload value become 49910.

Timer cannot be used at the same time as the servo command, as the servo command requires sole use of the timer to calculate the servo pulse intervals.

Example:

```
settimer t1s_4      ' settimer to 1 second ticks at 4MHz
main:
pause 10000         ' wait 10 seconds
debug              ' display timer value
goto main          ' loop
```

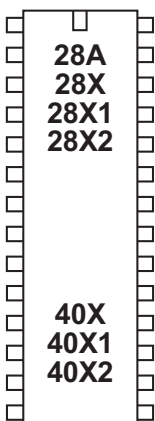
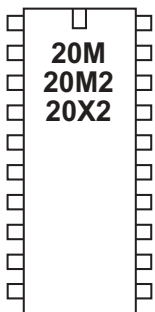
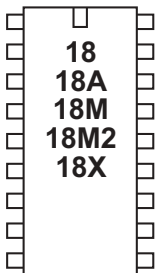
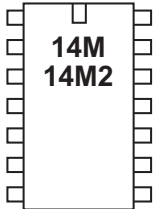
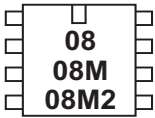
shiftin (spiin)

Syntax:

SPiIN *sc*lk,*s*data,*m*ode,(*v*ariable {/ bits} {, variable {/ bits}, ...})

- *sc*lk is a variable/constant which specifies the i/o pin to use as clock.
- *s*data is a variable/constant which specifies the i/o pin to use as data.
- Mode is a variable/constant (0-7) which specifies the mode:

0	MSBPre_L	(MSB first, sample before clock, idles low)
1	LSBPre_L	(LSB first, sample before clock, idles low)
2	MSBPost_L	(MSB first, sample after clock, idles low)
3	LSBPost_L	(LSB first, sample after clock, idles low)
4	MSBPre_H	(MSB first, sample before clock, idles high)
5	LSBPre_H	(LSB first, sample before clock, idles high)
6	MSBPost_H	(MSB first, sample after clock, idles high)
7	LSBPost_H	(LSB first, sample after clock, idles high)
- Variable receives the data.
- Bits is the optional number of bits to transmit. If omitted the default is 8.

Information:

The spiin (shiftin also accepted by the compiler) command is a 'bit-bang' method of SPI communication on the X1 and X2 parts ONLY. All other parts must use the sample program included overleaf to duplicate this behaviour.

For a hardware solution for X1/X2 parts see the 'hshin' command.

By default 8 bits are shifted into the variable. A different number of bits (1 to 8) can be defined via the optional / bits. Therefore, for instance, if you require to shift in 12 bits, do this as two bytes, one byte shifting 8 bits and the second byte shifting 4 bits. Note that if you are using the LSB first method, the bits are shifted right (in from the left) and so shifting just 4 bits would leave them located in bits 7-4 (not 3-0). With the MSB method the bits are shifted left (in from the right).

When connected SPI devices (e.g. EEPROM) remember that the data-in of the EEPROM connects to the data-out of the PICAXE, and vice versa.

Other PICAXE microcontrollers do not have a direct spiin (shiftin) command. However the same functionality found in other products can be achieved by using the sub procedures listed overleaf.

Effect of increased clock speed:

Increasing the clock speed increases the SPI clock frequency.

Example:

```
spiin 2,1,LSB_Pre_H, (b1 / 8) ' clock 8 bits into b1
```

shiftn/shiftout on PICAXE chips without native commands:

Some PICAXE microcontrollers do not have a shiftn command. However the same functionality found in other products can be achieved by using the sub procedures provided below. These sub-procedures are also saved in the file called shiftn_out.bas in the \samples folder of the Programming Editor software.

To use, simply copy the symbol definitions to the top of your program and copy the appropriate shiftn sub procedures to the bottom of your program.

Do not copy all options as this will waste memory space.

It is presumed that the data and clock outputs (sdata and sclk) are in the low condition before the gosub is used.

BASIC line

```
“shiftn sclk, sdata,mode, (var_in(\bits)) “
```

becomes

```
gosub shiftn_LSB_Pre      (for mode LSBPre)
gosub shiftn_MSB_Pre     (for mode MSBPre)
gosub shiftn_LSB_Post    (for mode LSBPost)
gosub shiftn_MSB_Post    (for mode MSBPost) ‘
```

```
‘ ----- SYMBOL DEFINITIONS -----
```

```
‘ Required for all routines. Change pin numbers/bits as required.
‘ Uses variables b7-b13 (i.e. b7,w4,w5,w6). If only using 8 bits
‘ all the word variables can be safely changed to byte variables.
‘
```

```
‘***** Sample symbol definitions *****
```

```
symbol sclk = 5          ‘ clock (output pin)
symbol sdata = 7        ‘ data (output pin for shiftout)
symbol serdata = input7 ‘ data (input pin for shiftn, note input7
symbol counter = b7     ‘ variable used during loop
symbol mask = w4        ‘ bit masking variable
symbol var_in = w5      ‘ data variable used durig shiftn
symbol var_out = w6     ‘ data variable used during shiftout
symbol bits = 8         ‘ number of bits
symbol MSBvalue = 128  ‘ MSBvalue
                        ‘ (=128 for 8 bits, 512 for 10 bits, 2048 for 12 bits)
```

```

=====
' ----- SHIFTIM ROUTINES -----
' Only one of these 4 is required - see your IC requirements
' It is recommended you delete the others to save space
=====
' ***** Shiftin LSB first, Data Pre-Clock *****
shiftin_LSB_Pre:
    let var_in = 0
    for counter = 1 to bits ' number of bits
    var_in = var_in / 2 ' shift right as LSB first
    if serdata = 0 then skipLSBPre
    var_in = var_in + MSBValue ' set MSB if serdata = 1
skipLSBPre:
    pulsout sclk,1 ' pulse clock to get next data bit
    next counter
    return
=====
' ***** Shiftin MSB first, Data Pre-Clock *****
shiftin_MSB_Pre:
    let var_in = 0
    for counter = 1 to bits ' number of bits
    var_in = var_in * 2 ' shift left as MSB first
    if serdata = 0 then skipMSBPre
    var_in = var_in + 1 ' set LSB if serdata = 1
skipMSBPre:
    pulsout sclk,1 ' pulse clock to get next data bit
    next counter
    return
=====
' ***** Shiftin LSB first, Data Post-Clock ***** '
shiftin_LSB_Post: let var_in = 0
    for counter = 1 to bits ' number of bits
    var_in = var_in / 2 ' shift right as LSB first
    pulsout sclk,1 ' pulse clock to get next data bit
    if serdata = 0 then skipLSBPost
    var_in = var_in + MSBValue ' set MSB if serdata = 1
skipLSBPost:
    next counter
    return
=====
' ***** Shiftin MSB first, Data Post-Clock *****
shiftin_MSB_Post: let var_in = 0
    for counter = 1 to bits ' number of bits
    var_in = var_in * 2 ' shift left as MSB first
    pulsout sclk,1 ' pulse clock to get next data bit
    if serdata = 0 then skipMSBPost
    var_in = var_in + 1 ' set LSB if serdata = 1
skipMSBPost:
    next counter
    return
=====

```

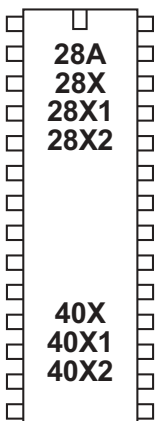
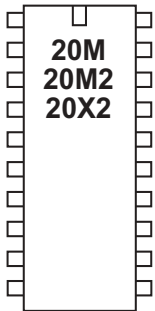
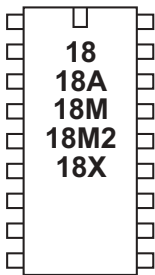
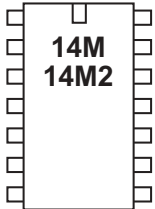
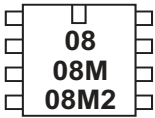

shiftout (spiout)

Syntax:

SPIOUT *clock,sdata,mode,{data{/ bits}, {data{/ bits},...}*)

- *clock* is a variable/constant which specifies the i/o pin to use as clock.
- *sdata* is a variable/constant which specifies the i/o pin to use as data.
- Mode is a variable/constant (0-3) which specifies the mode:

0	LSBFirst_L	(LSB first, idles low)
1	MSBFirst_L	(MSB first, idles low)
4	LSBFirst_H	(LSB first, idles high)
5	MSBFirst_H	(MSB first, idles high)
- Data is a variable/constant that contains the data to send.
- Bits (optional) is the number of bits to transmit. If omitted the default number of bits is automatically set to 8.

Information:

The spiout (shiftout is also accepted by the compiler) command is a bit-bang of SPI communication on the X1 and X2 parts ONLY. All other parts must use the sample program included overleaf to duplicate this behaviour.

For a hardware solution for X1/X2 parts see the 'hspiout' command

By default 8 bits are shifted out. A different number of bits (1 to 8) can be defined via the optional / bits. Therefore, for instance, if you require to shift out 12 bits, do this as two bytes, one byte shifting 8 bits and the second byte shifting 4 bits. Note that if you are using the MSB first method, the bits are shifted left (out from the left) and so when shifting just 4 bits they must be located in bits 7-4 (not 3-0). With the LSB method the bits are shifted out from the right.

When connected SPI devices (e.g. EEPROM) remember that the data-in of the EEPROM connects to the data-out of the PICAXE, and vice versa.

Some PICAXE microcontrollers do not have a shiftout command. However the same functionality found in other products can be achieved by using the sub procedures listed below.

Effect of increased clock speed:

Increasing the clock speed increases the SPI clock frequency.

Example:

```
spiout 1,2,LSB_First, (b1 / 8) ' clock 8 bits from b1
```

shiftn/shiftout on PICAXE chips without native commands:

Some PICAXE microcontrollers do not have a shiftn command. However the same functionality found in other products can be achieved by using the sub procedures provided below. These sub-procedures are also saved in the file called shiftn_out.bas in the \samples folder of the Programming Editor software.

To use, simply copy the symbol definitions (listed within the shiftn command) to the top of your program and copy the appropriate shiftout sub procedures below to the bottom of your program.

Do not copy both options as this will waste memory space.

It is presumed that the data and clock outputs (sdata and sclk) are in the low condition before the gosub is used.

BASIC line

“shiftout sclk, sdata,mode, (var_out(\bits))”

becomes

gosub shiftout_LSBFirst (for mode LSBFirst)

gosub shiftout_MSBFirst (for mode MSBFirst)

Note the symbol definitions listed in the ‘shiftn’ command must also be used.

```

=====
' ***** Shiftout LSB first *****
shiftout_LSBFirst:
    for counter = 1 to bits          ' number of bits
    mask = var_out & 1              ' mask LSB
    low sdata                        ' data low
    if mask = 0 then skipLSB
    high sdata                       ' data high
skipLSB:    pulsout sclk,1          ' pulse clock for 10us
    var_out = var_out / 2           ' shift variable right for LSB
    next counter
    return
=====
' ***** Shiftout MSB first *****
shiftout_MSBFirst:
    for counter = 1 to bits          ' number of bits
    mask = var_out & MSBValue       ' mask MSB
    high sdata                       ' data high
    if mask = 0 then skipMSB
    low sdata                         ' data low
skipMSB:    pulsout sclk,1          ' pulse clock for 10us
    var_out = var_out * 2           ' shift variable left for MSB
    next counter
    return
=====

```

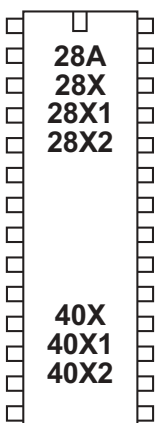
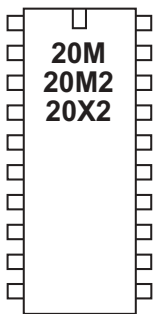
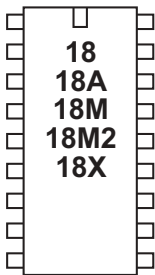
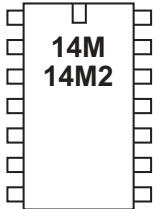
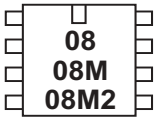

sleep



Syntax:

SLEEP period

- Period is a variable/constant which specifies the duration of sleep in multiples of 2.3 seconds (1-65535).

Function:

Sleep for some period (multiples of approximately 2.3s (2.1s on X1/X2 parts)).

Information:

The sleep command puts the microcontroller into low power mode for a period of time. When in low power mode all timers are switched off and so the pwmout and servo commands will cease to function. The nominal period is 2.3s, so sleep 10 will be approximately 23 seconds. The sleep command is not regulated and so due to tolerances in the microcontrollers internal timers, this time is subject to -50 to +100% tolerance. The external temperature affects these tolerances and so no design that requires an accurate time base should use this command.

Shorter 'sleeps' are possible with the 'nap' command (where supported).

Some PICAXE chips support the disablebod (enablebod) command to disable the brown-out detect function. Use of this command prior to a sleep will considerably reduce the current drawn during the sleep command.

On non-X2 parts the command 'sleep 0' is ignored.

On X2 parts 'sleep 0' puts the microcontroller into permanent sleep - it does not wake every 2.1 seconds. The microcontroller is only woken by a hardware interrupt (e.g. hint pin change) or hard-reset. The chip will not respond to new program downloads when in permanent sleep.

Effect of increased clock speed:

The sleep command uses the internal watchdog timer which is not affected by changes in resonator clock speed.

Example:

```
main: high 1           ' switch on output 1
      sleep 10        ' sleep for 23 seconds
      low 1           ' switch off output 1
      sleep 100       ' sleep for 230 seconds
      goto main       ' loop back to start
```

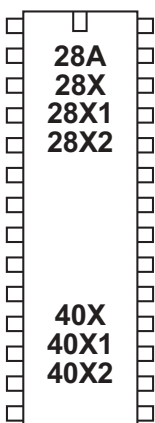
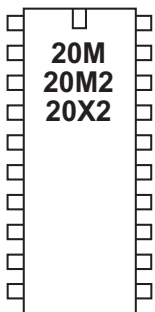
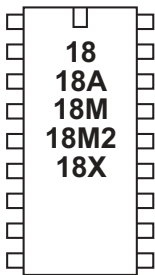
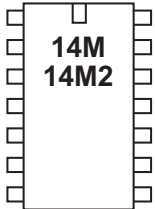
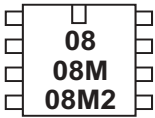

sound



Syntax:

SOUND pin,(note,duration,note,duration...)

- Pin is a variable/constant which specifies the i/o pin to use.
- Note(s) are variables/constants (0-255) which specify type and frequency. Note 0 is silent for the duration. Notes 1-127 are ascending tones. Notes 128-255 are ascending white noises.
- Duration(s) are variables/constants (0-255) which specify duration (multiples of approx 10ms).

Function:

Play sound 'beep' noises.

Information:

This command is designed to make audible 'beeps' for games and keypads etc. To play music use the play or tune command instead. Note and duration must be used in 'pairs' within the command.

See the tune command for suitable piezo / speaker circuits.

Effect of Increased Clock Speed:

The length of the note is halved at 8MHz and quartered at 16MHz.

Example:

```
main: let b0 = b0 + 1           ; increment b0
      sound B.7, (b0,50)       ; make a sound
      goto main                ; loop back to start
```

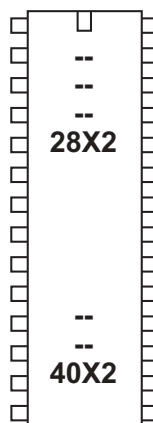
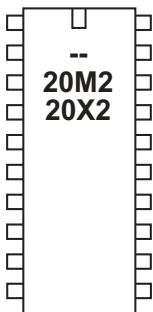
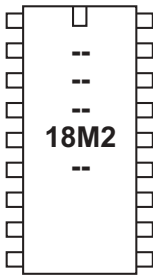
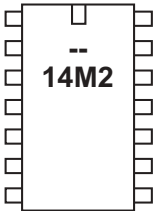
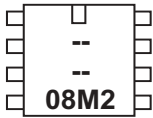

Firmware >= B.3

sr latch*Syntax:***SRLATCH config1, config2**

- Config1 is a variable/constant which specifies the latch configuration

Bit 7 = 1 SR Latch is active

= 0 SR Latch is not used

Bit 6-4 SR Clock Divider Bits - sets latch clock frequency

654	Divider	16MHz	8MHz	4MHz
000	1/4	0.25us	0.5us	1us
001	1/8	0.5	1	2
010	1/16	1	2	4
011	1/32	2	4	8
100	1/64	4	8	16
101	1/128	8	16	32
110	1/256	16	32	64
111	1/512	32	64	128

Bit 3 = 1 Q is present on pin SRQ (when an output)

= 0 Pin SRQ is not used by the SR Latch module

Bit 2 = 1 NOT Q is present on pin SRNQ (when an output)

= 0 Pin SRNQ is not used by the SR Latch module

Bit 1 = 0 Not used, leave as 0

Bit 0 = 0 Not used, leave as 0

Note that not all parts have both SRQ and SRNQ pins. Some parts have just SRQ and some have just SRNQ. See the pin out diagrams for the PICAXE chip in use.

Note also that as SRNQ on the 28X2/40X2 parts is the sertxd programming pin 'debug' and 'sertxd' commands will not function when SRNQ is set active (via bit 2).

- Config2 is a variable/constant which specifies the set/reset configuration.

When the bit is low the feature has no effect on the SR latch.

For 20X2 part:

Bit 7 = 1 HINT1 sets latch (see hintsetup)

Bit 6 = 1 Latch set pin is pulsed by clock (see above)

Bit 5 = 1 C2 comparator sets latch (see compsetup)

Bit 4 = 1 C1 comparator sets latch (see compsetup)

Bit 3 = 1 HINT1 resets latch (see hintsetup)

Bit 2 = 1 Latch reset pin is pulsed by clock (see above)

Bit 1 = 1 C2 comparator resets latch (see compsetup)

Bit 0 = 1 C1 comparator resets latch (see compsetup)

For 28X2/40X2 parts:

Bit 7 = 1 SRI pin high sets latch

Bit 6 = 1 Latch set pin is pulsed by clock (see above)

Bit 5 = 1 C2 comparator sets latch (see compsetup)

Bit 4 = 1 C1 comparator sets latch (see compsetup)

Bit 3 = 1 SRI pin high resets latch

Bit 2 = 1 Latch reset pin is pulsed by clock (see above)

Bit 1 = 1 C2 comparator resets latch (see compsetup)

Bit 0 = 1 C1 comparator resets latch (see compsetup)

Note that on 28X2/40X2 parts the SRI pin can act as either a set or reset pin by setting bit 3 or bit 7. Do not set both bits at the same time!

For M2 parts:

Bit 7	= 1	SRI pin high sets latch	
Bit 6	= 1	Latch set pin is pulsed by clock	(see above)
Bit 5	= 0	Not used, leave as 0	
Bit 4	= 0	Not used, leave as 0	
Bit 3	= 1	SRI pin high resets latch	
Bit 2	= 1	Latch reset pin is pulsed by clock	(see above)
Bit 1	= 0	Not used, leave as 0	
Bit 0	= 0	Not used, leave as 0	

Note that on M2 parts the SRI pin can act as either a set or reset pin by setting bit 3 or bit 7. Do not set both bits at the same time!

Function:

Setup the internal hardware SR latch. The latch can be set by the SRSET command, or one of the peripherals listed above. Similarly the latch can be reset by the SRRESET command or one of the peripherals. If both SET and RESET signals are present the latch goes to the RESET state.

Information:

Some PICAXE microcontrollers have an internal hardware SR latch. This latch can be used independently of the PICAXE program, so that, for instance, an output can be INSTANTLY controlled directly via the latch.

The SR latch also contains an internal clock source. This means the SR latch can be optionally configured to act like a '555 timer'.

The output (Q) of the latch can be made available on pin SRQ (if present). The inverse of the output (NOT Q) can be made available on pin SRNQ (if present).

The srlatch command does not automatically configure these pins as outputs, this must be carried out by the user program before use.

Example for 20X2:

```

init: low B.1
      high C.4
      srlatch %10001100, %00000000
main: srset          ; set the latch
      pause 5000
      srreset       ; reset the latch
      pause 5000
      goto main     ; loop back to start

```

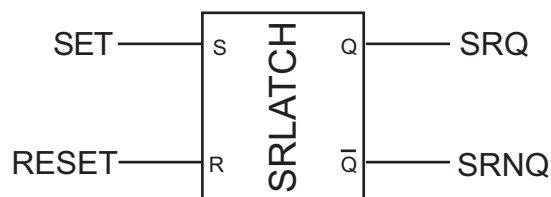

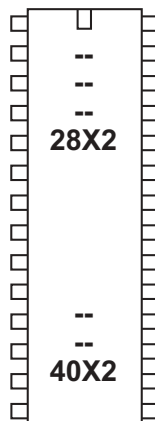
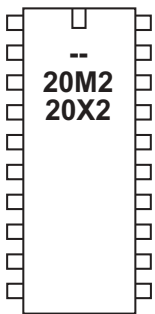
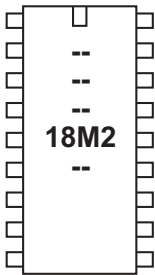
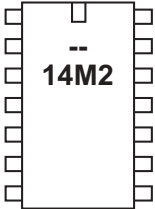
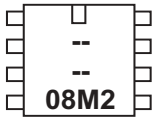

Firmware>=B.3

srset / srreset

Syntax:

SRSET
SRRESET

Function:

Set or reset the hardware SR latch.

Information:

These two commands can set or reset the SR latch via the PICAXE program. Note that the SR latch can also be configured to be set or reset by hardware peripherals - see the SRLATCH command for more details.

Example for 20X2:

```

init: low B.1
      high C.4
      srlatch %10001100, %00000000
main: srset
      pause 5000
      srreset
      pause 5000
      goto main ; loop back to start
    
```

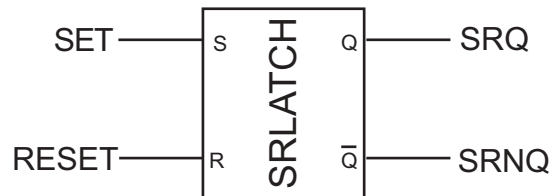

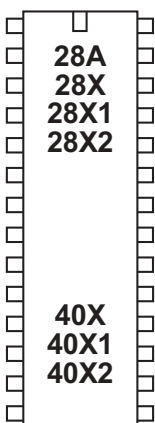
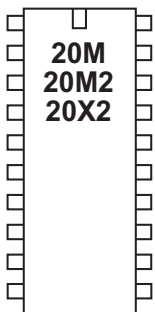
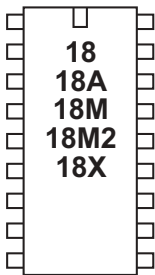
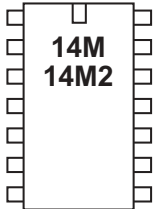
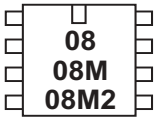

stop



Syntax:

STOP

Function:

Enter a permanent stop loop until the power cycles (program re-runs) or the PC connects for a new download.

Information:

The stop command places the microcontroller into a permanent loop at the end of a program. Unlike the end command the stop command does not put the microcontroller into low power mode after a program has finished.

The stop command does not switch off internal timers, and so commands such as servo and pwmout that require these timers will continue to function.

Example:

main:

```
pwmout C.1,120,400
stop
```

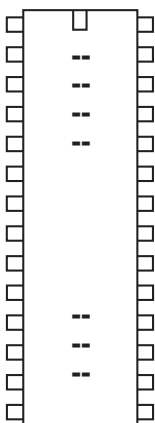
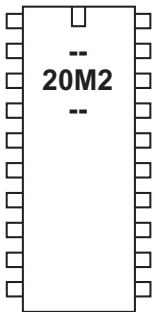
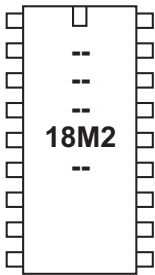
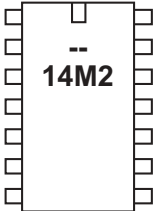
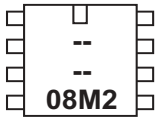

suspend

Syntax:

suspend task

- task is a variable/constant which indicates which task to suspend

Function:

Suspend (pause) a task.

Information:

M2 parts can process a number of tasks in parallel. The suspend command is used to pause a task. All other tasks continue as normal. If the task is already running the command is ignored. If your program requires the task to be suspended as the chip resets, use a suspend command as the first command in that task. It will then suspend itself as soon as the chip resets.

Do not suspend all tasks at the same time!

Example:

start0:

```

high B.0           ; B.0 high
pause 100          ; wait for 0.1 second
low B.0            ; B.0 low
pause 100          ; wait for 0.1 second
goto start0        ; loop

```

start1:

```

pause 5000         ; wait 5 seconds
suspend 0          ; suspend task 0
pause 5000         ; wait 5 seconds
resume 0           ; resume task 0
goto start1        ; loop

```

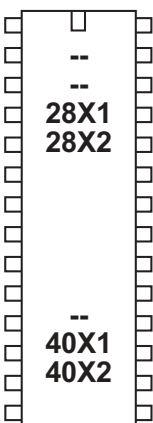
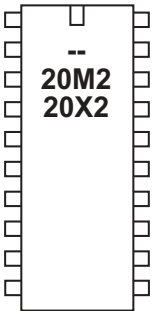
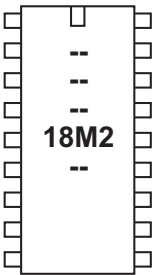
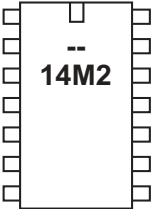
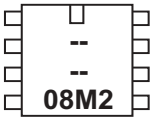

swap

Syntax:

SWAP variable1, variable2

Function:

Swap the values between two variables.

Information:

The swap command simply exchanges values between two variables.

Example:

```

    b1 = 5
    b2 = 10
main:
    swap b1,b2
    debug
    pause 1000
    goto main
  
```

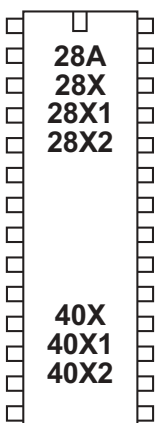
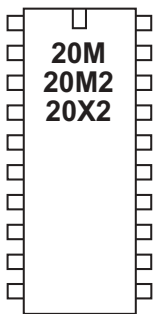
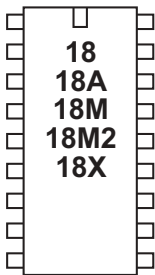
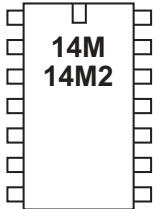
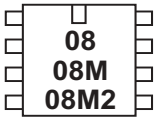

switch on/ off

Syntax:

SM TCH ON pin, pin, pin...

SM TCHON pin, pin, pin...

SM TCH OFF pin, pin, pin...

SM TCHOFF pin, pin, pin...

- Pin is a variable/constant which specifies the i/o pin to use.

Function:

Make pin output high / low.

Information:

This is a 'pseudo' command designed for use by younger students. It is actually equivalent to 'high' or 'low', ie the software outputs a high or low command as appropriate.

Example:

```

main: switch on 7           ' switch on output 7
      wait 5                ' wait 5 seconds
      switch off 7         ' switch off output 7
      wait 5                ' wait 5 seconds
      goto main            ' loop back to start
  
```

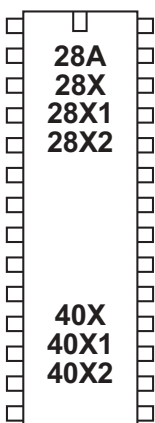
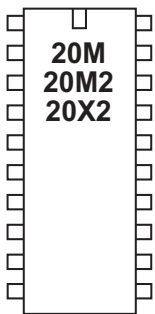
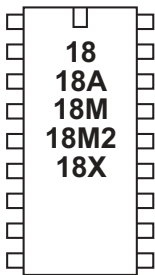
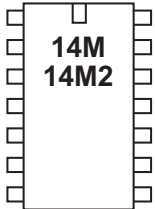
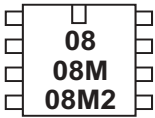

symbol

Syntax:

SYMBOL symbolname = value

SYMBOL symbolname = value ?? constant

- Symbolname is a text string which must begin with an alpha-character or '_'. After the first character, it can also contain number characters ('0'-'9').
- Value is a variable or constant which is being given an alternate symbolname.
- ?? can be any supported mathematical function e.g. + - * / etc.

Function:

Assign a value to a new symbol name.

Mathematical operators can also be used on constants (not variables)

Information:

Symbols are used to rename constants or variables to make them easier to remember during a program. Symbols have no effect on program length as they are converted back into 'numbers' before the download.

Symbols can contain numeric characters, but must not start with a numeric character. Naturally symbol names cannot be command names or reserved words such as input, step, etc. See the list of reserved words at the end of this section.

When using input and output pin definitions take care to use the term 'pin0' not '0' when describing input variables to be used within if...then statements.

Example:

```
symbol RED_LED = B.7    ; define a output pin
symbol PUSH_SW = pinC.1 ; define a input switch
symbol DELAY = b0      ; define a variable symbol
```

```
let DELAY = 200    ; preload counter with 200
main: high RED_LED ; switch on output 7
pause DELAY       ; wait 0.2 seconds
low RED_LED       ; switch off output 7
pause DELAY       ; wait 0.2 seconds
goto main         ; loop back to start
```

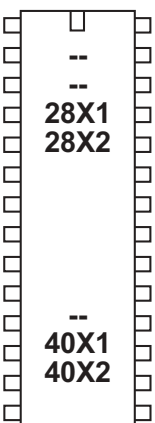
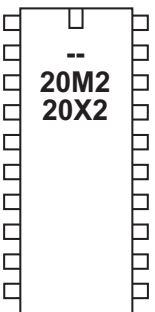
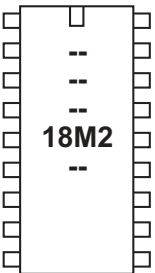
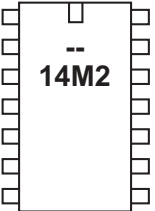
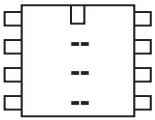

table

Syntax:

TABLE {location},(data,data...)

- Location is an optional constant which specifies where to begin storing the data in the program memory table. If no location is specified, storage continues from where it last left off. If no location was initially specified, storage begins at 0.
- Data are byte constants (0-255) which will be stored in the table.

Function:

Preload a lookup table for embedding in the downloaded program.

M2 parts have 512 locations (0-511). Other parts have 256 (0-255)

Information:

This is not an instruction, but a method of pre-loading the microcontroller's program memory lookup table. The data can then be read via the readtable command (the data is fixed, cannot be altered apart from at program download). The tablecopy command may be used to copy the table data to RAM in sections.

Example:

```
TABLE 0,("Hello World")      ; save values in table

main:
  for b0 = 0 to 10           ; start a loop
    readtable b0,b1         ; read value from table
    serout 7,N2400,(b1)     ; transmit to serial LCD module
  next b0                   ; next character
```

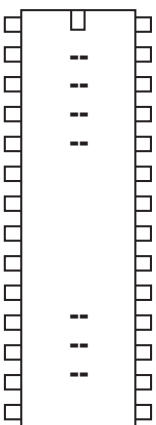
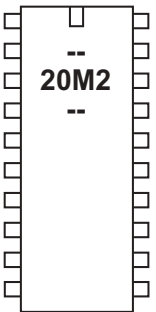
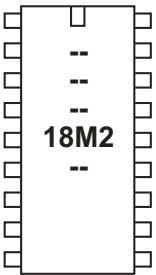
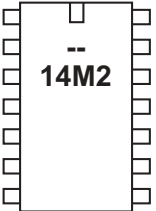
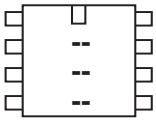
tablecopy

Syntax:

TABLECOPY start_location,block_size

- Start_location is the start address of the block to be copied (0-511)
- Block_size is the number of bytes to be copied to RAM (1-512)

Function:

Copy the lookup table to RAM. Each address is copied directly, i.e. table address 0 is copied to RAM address 0 (which is also byte variable b0).

Information:

The tablecopy command may be used to rapidly copy the table data to RAM in user defined 'blocks'. This is useful, for instance, to preload string data into RAM. Each copy is made to exactly the same address in RAM, so that it can then be accessed via peek or @bptr.

The copy will cease if the maximum address of the table (511) is exceeded.

Note that the lower bytes of RAM are always shared with the byte variables. Therefore copying locations 0,1,2 etc. will overwrite b0,b1,b2 etc.

Example:

```
TABLE 0,("Hello World")      ; save values in table

main:
    tablecopy 0,5             ; copy addresses 0,1,2,3,4
    debug                    ; show b0-b4 on screen
    goto main                 ; loop
```

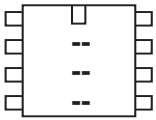

tmr3setup

Syntax:

TMR3SETUP config

- config is a constant/variable that configures timer3.

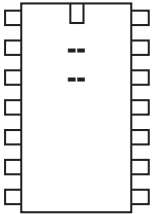

config is defined as (20X2, 28X2-5V, 28X2-3V, 40X2-3V, 40X2-5V)

Bit 7	Must be set	(1)
Bit 6	Must be clear	(0)
Bit 5, 4	1 : 8 Prescale	(11)
	1 : 4 Prescale	(10)
	1 : 2 Prescale	(01)
	1 : 1 Prescale	(00)
Bit 3	Must be clear	(0)
Bit 2	Must be clear	(0)
Bit 1	Must be clear	(0)
Bit 0	Timer 3 Enable	(1 = on, 0 = off)

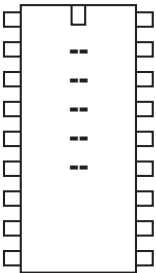

config is defined as (28X2, 40X2)

Bit 7	Must be clear	(0)
Bit 6	Must be clear	(0)
Bit 5, 4	1 : 8 Prescale	(11)
	1 : 4 Prescale	(10)
	1 : 2 Prescale	(01)
	1 : 1 Prescale	(00)
Bit 3	Must be clear	(0)
Bit 2	Must be clear	(0)
Bit 1	Must be set	(1)
Bit 0	Timer 3 Enable	(1 = on, 0 = off)

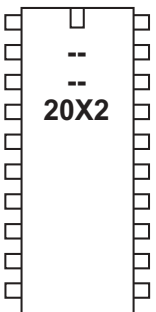

Function:

Configure the internal timer3 on X2 parts.

Information:

The tmr3setup command configures the internal timer3 on X2 parts. This is a free running timer that can be used for user background timing purposes.

The internal timer counts, when enabled, at a rate of (1/resonator speed) * 4. This means, for instance, at 8MHz the internal timer increment occurs every 0.5us. This value can be optionally scaled by the prescale value (set via bits 5:4) , so with a 1 : 8 prescale the increment will occur every 4us (8 x 0.5us).

The PICAXE word variable 'timer3' increments on every overflow of the internal timer, ie 65536 x the increment delay. So at 8MHz with 1:8 prescalar the timer3 value will increment every 262144us (262ms).

'timer3' is a word length variable

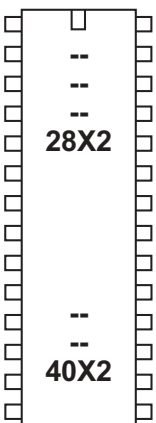

Example (for 28X2):

```
        tmr3setup  %00110011  ; timer3 on, 1:8 prescalar

main:  pause 500                ; short delay
       debug                  ; display timer3 value
       goto main
```

Example (for 28X2-5V or 28X2-3V):

```
        tmr3setup  %10110001  ; timer3 on, 1:8 prescalar

main:  pause 500                ; short delay
       debug                  ; display timer3 value
       goto main
```

Example (code suitable to automatically select 28X2, 28X2-3V, or 28X2-5V):

```
        readsilicon b1          ; get chip silicon type
        b1 = b1 & %11100000     ; mask out type bits

        if b1 = %10000000 then  ; chip is 28X2
          tmr3setup %00110011  ; timer3 on, 1:8 prescalar
        else                    ; other type of chip
          tmr3setup %10110001  ; timer3 on, 1:8 prescalar
        endif

main:  pause 500                ; short delay
       debug                  ; display timer3 value
       goto main
```

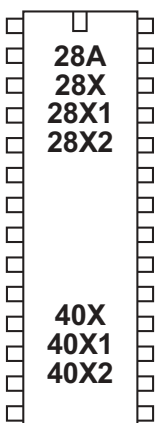
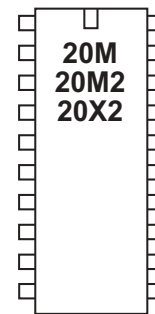
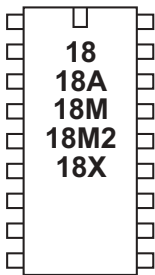
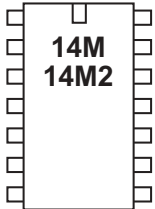
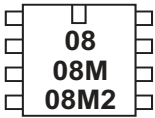

toggle



Syntax:

TOGGLE pin, pin, pin...

- Pin is a variable/constant which specifies the i/o pin to use.

Function:

Make pin output and toggle state.

Information:

The high command inverts an output (high if currently low and vice versa)

On microcontrollers with configurable input/output pins (e.g. PICAXE-08) this command also automatically configures the pin as an output.

Example:

```
main:
    toggle B.7      ; toggle output 7
    pause 1000     ; wait 1 second
    goto main      ; loop back to start
```

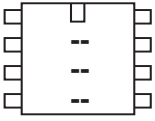

togglebit

Syntax:

TOGGLEBIT var, bit

- var is the target variable.
- bit is the target bit (0-7 for byte variables, 0-15 for word variables)

Function:

Toggle (invert) a specific bit in the variable.

Information:

This command toggles (inverts) a specific bit in the target variable.

Examples:

```
togglebit b6, 0
togglebit w4, 15
```

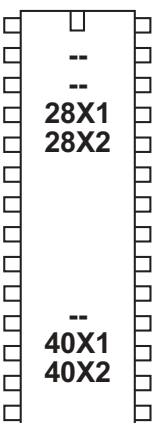
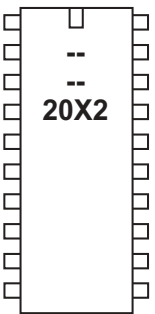
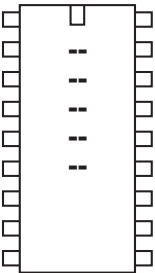
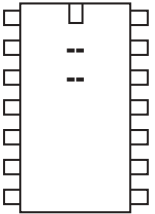

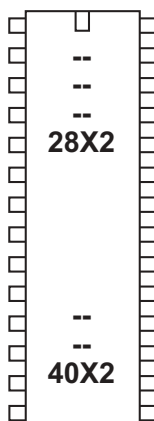
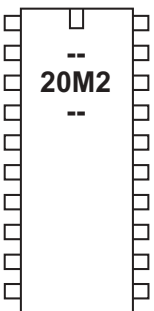
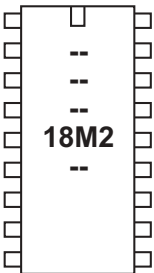
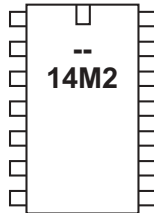
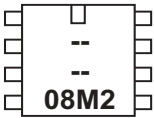

Firmware>=B.3

touch

Syntax:

TOUCH channel, variable

- Channel is a variable/constant specifying the ADC pin
- Variable receives the byte touch reading

Function:

Read the touch sensor on the ADC channel and save reading into byte variable. This command automatically configures the pin as an ADC and as a touch sensor.

Note that the touch command is a 'pseudo' command that actually processes a 'touch16' command and then scales the 16 bit result to fit in a byte (to give a byte reading 0-255). This makes byte mathematics easier in simple programs but does mean that the touch sensor accuracy is reducing by the scaling process.

When possible it is recommended that a 'touch16' command with a word variable is used instead. This will maintain the highest possible accuracy.

Please note that the touch reading can be affected by long serial cables connected to the project PCB (e.g. the older AXE026 download cable). Therefore it is not recommended that the older AXE026 serial cable (or AXE026/USB adapter combination) is used when trying to calibrate the touch command as it can affect the readings, only use the AXE027 USB cable for this calibration.

Due to the design of the silicon inside the microcontroller each pin will give slightly different readings. Therefore each pin must be calibrated separately.

See the 'touch16' command description for more details about using touch sensors.

Affect of increased clock speed:

The clock speed will affect the count rate and so the result will change for each clock speed. Therefore the touch command must be calibrated at the actual clock speed in use.

Example:

```
main:
  touch C.1,b0      ; read value into b0
  if b0 > 100 then
    high b.2        ; output B.2 on
  else
    low b.2         ; output b.2 off
  endif
  goto main        ; else loop back to start
```

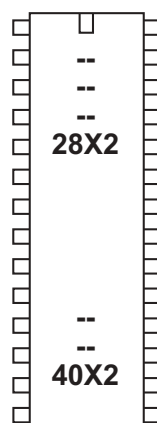
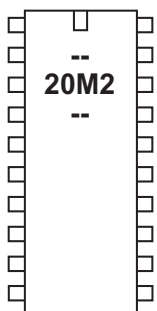
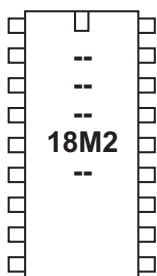
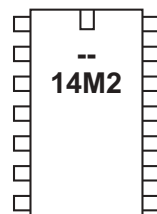
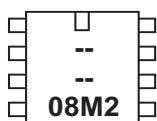

Firmware>=B.3

touch16

Syntax:

TOUCH16 channel, wordvariable

TOUCH16 [config], channel, wordvariable

- Channel is a variable/constant specifying the ADC pin
- Wordvariable receives the 16 bit touch reading (10 bit on X2 parts)
- Config is an optional variable/constant specifying a configuration value

Function:

Read the touch sensor on the ADC channel and save reading into word variable. This command automatically configures the pin as an ADC and as a touch sensor.

Information:

The touch16 command is used to read the touch sensor value from the microcontroller touch pin. Note that not all inputs have internal ADC / touch functionality - check the pinout diagrams for the PICAXE chip you are using. Note that touch16 requires use of a word variable (e.g. w1 not b1), use the touch command for a byte variable.

IMPORTANT - Never 'directly touch' a touch sensor (e.g. a piece of bare wire)! A touch sensor must be electrically isolated from the end user. On a commercial PCB this can be as simple as the 'solder resist' lacquer layer printed over the pad, or on a home made PCB this can be achieved by placing a small piece of 2mm plastic over the PCB pad (the copper pad should be at least 15mm in diameter). The top of a plastic project box makes an ideal insulator. Simply stick the PCB to the inside of the box and place a 'sticker' as a target on the outside of the box.

Note touch sensor pads must NOT have any other electrical connection than the connection to the PICAXE pin (e.g. touch sensor pads must not include a 10k pull up or pull down resistor as found on many project boards).

Please note that the touch16 reading can be affected by long serial cables connected to the project PCB (e.g. the older AXE026 download cable). Therefore it is not recommended that the older AXE026 serial cable (or AXE026/USB adapter combination) is used when trying to calibrate the touch16 command as it can affect the readings, only use the AXE027 USB cable for this purpose.

Due to the design of the silicon inside the microcontroller each pin will give slightly different readings. Therefore each pin must be calibrated separately.

In simple terms a touch sensor works by detecting the change in capacitance when a finger is placed near the touch sensor pad. This capacitance affects the frequency of an internal oscillating signal. By measuring the time it takes for a set number of oscillations, the relative capacitance can be calculated. This value will change when the finger is placed nearby - the finger increases the total capacitance which then decreases the oscillation speed, and so the time taken (value) of the touch16 command increases.

Touch sensors do not work when wet, they must be kept dry.

A touch sensor pad is made from an area of copper pour on a PCB, approximately 15mm - 20mm in diameter. It can be any shape. When designing multiple sensors close by each other consider the width of a human finger and that user finger placement will not always be that accurate. Where possible print visual 'targets' above the pad and leave as large as space as possible between pads.

The AXE181 '18M2 touch sensor demo board' is the suggested low cost development board for trying out touch sensors.

Note that M2 and X2 parts have different internal silicon methods of measuring capacitance change. The X2 method is faster, but gives a 10 bit (0-1023) value instead of a 16 bit value.

Effect of increased clock speed:

The clock speed will effect the count rate and so the result will change for each clock speed. Therefore the touch16 command must be calibrated at the actual clock speed in use.

Example:

```
main:
  touch16 C.1,w0      ; read value into w0
  if w0 > 3000 then
    high B.2         ; output B.2 on
  else
    low B.2          ; output B.2 off
  endif
  goto main          ; else loop back to start
```

Configuration Byte - M2 parts

Normally the default configuration is recommended, so the optional config byte is not required within the touch16 command. However the optional 'config' byte can be used to fine tune the touch16 command operation if desired.

Config byte is broken down into 8 bits for M2 parts as follows:

bit7, 6, 5	=	Counter preload value (bits 7-5), e.g.
	=	000 Oscillation count required = 256
	=	010 Oscillation count required = 192
	=	100 Oscillation count required = 128
	=	110 Oscillation count required = 64
	=	111 Oscillation count required = 32
bit4,3	=	00 Touch sensor oscillator is off
	=	01 Low range (0.1uA)
	=	10 Medium range (1.2uA)
	=	11 High Range (18uA)
bit 2,1,0	=	Counter Prescalar (divide by 2 up to 256) e.g.
	=	001 Prescalar divide by 4

The default value for M2 parts is %000 01 001

Configuration Byte - X2 parts

Normally the default configuration is recommended, so the optional config byte is not required within the touch16 command. However the optional 'config' byte can be used to fine tune the touch16 command operation if desired.

Config byte is broken down into 8 bits for X2 parts as follows:

bit7, 6,	=	<i>Not used</i>
bit5,4	=	00 Touch sensor oscillator is off
	=	01 Nominal charge current
	=	10 Medium current (10 x Nominal)
	=	11 High current (100 x Nominal)
bit 3,2,1,0	=	Charge Time in multiples of 2us (1-15)

The default value for X2 parts is %0011 0010

(High current, charge time length multiple 2)

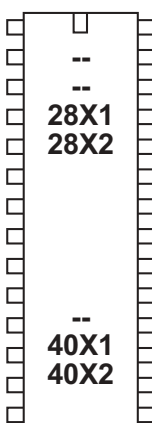
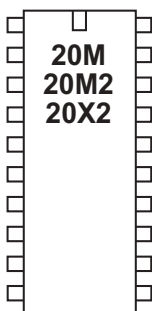
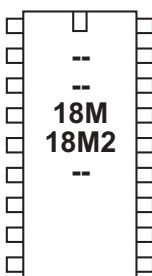
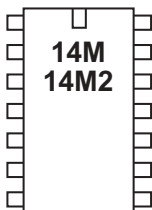
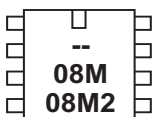

tune



Syntax:

TUNE pin, speed, (note, note, note...)

TUNE pin, speed, LED_mask, (note, note, note...) (M2 parts only)

TUNE LED_option, speed, (note, note, note...) (8 pin only)

- pin is a variable/constant which specifies the i/o pin to use (not available on 8 pin devices, which are fixed to output 2).
- speed is a variable/constant (1-15) which specifies the tempo of the tune.
- notes are the actual tune data generated by the Tune Wizard.
- LED_mask (M2 parts only) is a variable/constant which specifies if other PICAXE outputs (on the same port as the piezo) flash at the same time as the tune is being played. For example use %00000011 to flash output 0 and 1.
- LED_option (08M/08M2 only) is a variable/constant (0 -3) which specifies if other 8pin PICAXE outputs flash at the same time as the tune is being played.
 - 0 - No outputs
 - 1 - Output 0 flashes on and off
 - 2 - Output 4 flashes on and off
 - 3 - Output 0 and 4 flash alternately

Function:

Plays a user defined musical tune .

Information:

The tune command allows musical 'tunes' to be played.

Playing music on a microcontroller with limited memory will never have the quality of commercial playback devices, but the tune command performs remarkably well. Music can be played on economical piezo sounders (as found in musical birthday cards) or on better quality speakers.

The following information gives technical details of the note encoding process. However most users will use the 'Tune Wizard' to automatically generate the tune command, by either manually sequentially entering notes or by importing a mobile phone ring tone. Therefore the technical details are only provided for information only – they are not required to use the Tune Wizard.

Note that the tune command compresses the data, but the longer the tune the more memory that will be used. The 'play' command does not use up memory in the same way, but is limited to the 4 internal preset tunes.

All tunes play on a piezo sounder or speaker, connected to the output pin (must be output 2 (leg 5) of the 8 pin devices). Some sample circuits are shown later in this section.

On all 8 pin and all M2 parts other outputs can be enabled to cause them to 'flash' in time to the music. The LEDs 'toggle' on/off at the end of every note.

Speed:

The speed of music is normally called 'tempo' and is the number of 'quarter beats per minute' (BPM). This is defined within the PICAXE system by allocating a value of 1-15 to the speed setting.

The sound duration of a quarter beat within the PICAXE is as follows:

$$\text{sound duration} = \text{speed} \times 65.64 \text{ ms}$$

Each quarter beat is also followed by a silence duration as follows,

$$\text{silence duration} = \text{speed} \times 8.20 \text{ ms}$$

Therefore the total duration of a quarter beat is:

$$\begin{aligned} \text{total duration} &= (\text{speed} \times 65.64) \\ &\quad + (\text{speed} \times 8.20) \\ &= \text{speed} \times 73.84 \text{ ms} \end{aligned}$$

Therefore the approximate number of beats per minute (bpm) are:

$$\text{bpm} = 60\,000 / (\text{speed} \times 73.84)$$

A table of different speed values are shown here. This gives a good range for most popular tunes.

Speed	BPM
1	812
2	406
3	270
4	203
5	162
6	135
7	116
8	101
9	90
10	81
11	73
12	67
13	62
14	58
15	54

Note that within electronic music a note normally plays for 7/8 of the total note time, with silence for 1/8. With the PICAXE the ratio is slightly different (8/9) due to memory and mathematical limitations of the microcontroller.

Note Bytes:

Each note byte is encoded into 8 bits as shown. The encoding is optimised to ensure the most common values (1/4 beat and octave 6) both have a value of 00. Note that as the PICAXE also performs further optimisation on the whole tune, the length of the tune will not be exactly the same length as the number of note bytes. 1/16, 1/32 and 'dotted' notes are not supported.

76 = Duration	54 = Octave	3210 = Note
00 = 1/4	00 = Middle Octave (6)	0000 = C
01 = 1/8	01 = High Octave (7)	0001 = C#
10 = 1	10 = Low Octave (5)	0010 = D
11 = 1/2	11 = not used	0011 = D#

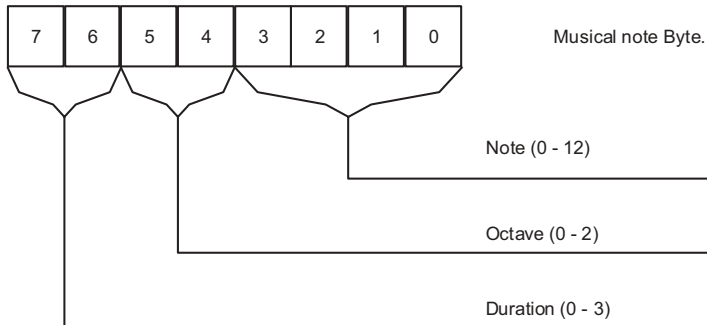

0100 = E
0101 = F
0110 = F#
0111 = G
1000 = G#
1001 = A
1010 = A#
1011 = B
11xx = Pause

Piano Representation of Note Frequency

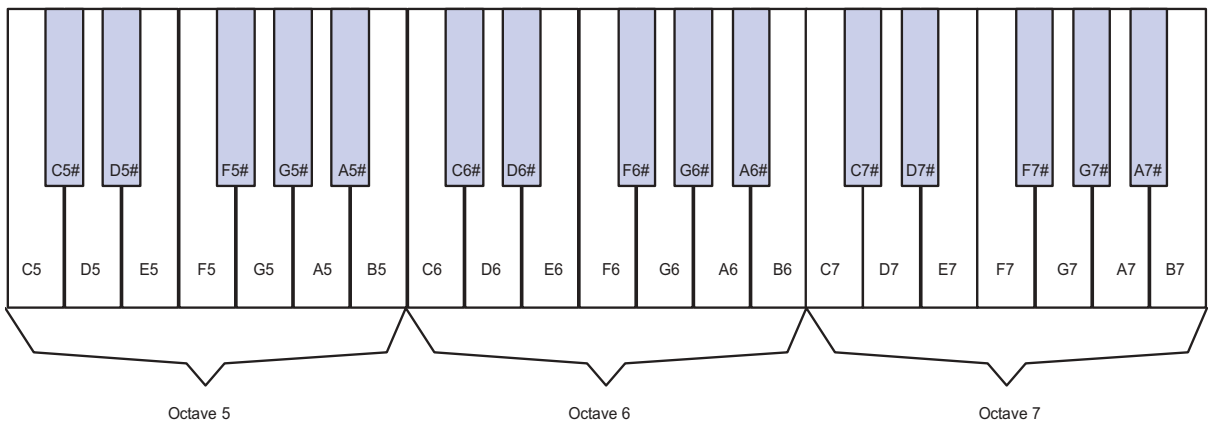

- C5 = 262 Hz
- C5# = 277 Hz
- D5 = 294 Hz
- D5# = 311 Hz
- E5 = 330 Hz
- F5 = 349 Hz
- F5# = 370 Hz
- G5 = 392 Hz
- G5# = 415 Hz
- A5 = 440 Hz
- A5# = 466 Hz
- B5 = 494 Hz

- C6 = 523 Hz ("Middle C")
- C6# = 554 Hz
- D6 = 587 Hz
- D6# = 622 Hz
- E6 = 659 Hz
- F6 = 698 Hz
- F6# = 740 Hz
- G6 = 784 Hz
- G6# = 831 Hz
- A6 = 880 Hz
- A6# = 932 Hz
- B6 = 988 Hz

- C7 = 1047 Hz
- C7# = 1109 Hz
- D7 = 1175 Hz
- D7# = 1245 Hz
- E7 = 1318 Hz
- F7 = 1396 Hz
- F7# = 1480 Hz
- G7 = 1568 Hz
- G7# = 1661 Hz
- A7 = 1760 Hz
- A7# = 1865 Hz
- B7 = 1975 Hz

PICAXE Tune Wizard

The Tune Wizard allows musical tunes to be created for the PICAXE. Tunes can be entered manually using the drop-down boxes if desired, but most users will prefer to automatically import a mobile phone monophonic ringtone. These ringtones are widely available on the internet in RTTTL format (used on most Nokia phones). Note the PICAXE can only play one note at a time (monophonic), and so cannot use multiple note (polyphonic) ringtones.

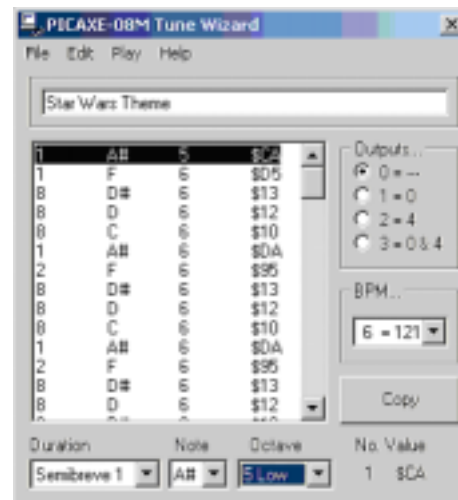

There are approximately 1000 tunes for free download on the software page of the www.picaxe.co.uk website.

To start the Tune Wizard click the PICAXE>Wizard>Tune Wizard menu.

The easiest way to import a ringtone from the internet is to find the tune on a web page. Highlight the RTTTL version of the ringtone in the web browser and then click Edit>Copy. Move back to the Tune Wizard and then click Edit>Paste Ringtone.

To import a ringtone from a saved text file, click File>Import Ringtone.

Once the tune has been generated, select whether you want outputs 0 and 4 to flash as the tune plays (from the options within the 'Outputs' section).

The tune can then be tested on the computer by clicking the 'Play' menu (if your computer is fitted with soundcard and speakers). The tune played will give a rough idea of how the tune will sound on the PICAXE, but will differ slightly due to the different ways that the computer and PICAXE generate and playback sounds. On older computers the tune generation may take a couple of seconds as generating the tune is very memory intensive.

Once your tune is complete click the 'Copy' button to copy the tune command to the Windows clipboard. The tune can then be pasted into your main program.

Tune Wizard menu items:

File	New	Start a new tune
	Open	Open a previously saved tune
	Save As	Save the current tune
	Import Ringtone	Open a ringtone from a text file
	Export Ringtone	Save tune as a ringtone text file
	Export Wave	Save tune as a Windows .wav sound file
	Close	Close the Wizard
Edit	Insert Line	Insert a line in the tune
	Delete Line	Delete the current line
	Copy BASIC	Copy the tune command to Windows clipboard
	Copy Ringtone	Copy tune as a ringtone to Windows clipboard
	Paste BASIC	Paste tune command into Wizard
	Paste Ringtone	Paste ringtone into Wizard
Play		Play the current tune on the computer's speaker
Help	Help	Start this help file.

Ring Tone Tips & Tricks:

1. After generating the tune, try adjusting the tempo by increasing or decreasing the speed value by 1 and listening to which 'speed' sounds best.
2. If your ringtone does not import, make sure the song title at the start of the line is less than 50 characters long and that all the text is saved on a single line.
3. Ringtones that contain the instruction 'd=16' after the description, or that contain many notes starting with 16 or 32 (the odd one or two doesn't matter) will not play correctly at normal speed on the PICAXE. However they may sound better if you double the PICAXE processor speed by using a 'setfreq m8' command before the tune command.
4. The PICAXE import filters 'round-down' dotted notes (notes ending with '.'). You may wish to change these notes into longer notes after importing.

Sound Circuits for use with the play or tune command.

The simplest, most economical, way to play the tunes is to use a piezo sounder. These are simply connected between the output pin (e.g. pin 2 (leg 5) of the PICAXE-08M2) and 0V (see circuits below).



The best piezo sound comes from the 'plastic cased' variants. Uncased piezos are also often used in schools due to their low cost, but the 'copper' side will need fixing to a suitable sound-board (piece of card, polystyrene cup or even the PCB itself) with double sided tape to amplify the sound.

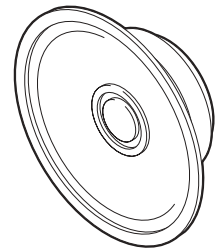

For richer sounds a speaker should be used. Once again the quality of the sound-box the speaker is placed in is the most significant factor for quality of sound. Speakers can be driven directly (using a series capacitor) or via a simply push-pull transistor amplifier.

A 40 or 80 ohm speaker can be connected with two capacitors as shown. For an 8 ohm speaker use a combination of the speaker and a 33R resistor in series (to generate a total resistance of 41R).

The output can also be connected (via a simple RC filter) to an audio amplifier such as the TBA820M.

The sample .wav sound files in the \music sub-folder of the Programming Editor software are real-life recordings of tunes played (via a speaker) from the microcontroller chip.

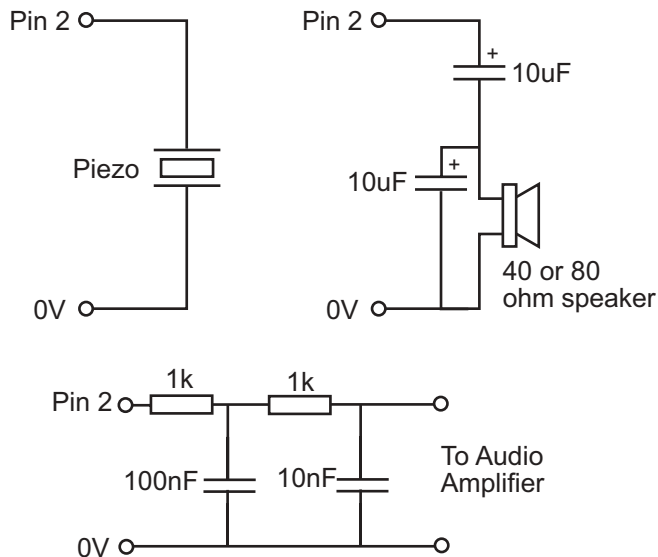

Ringing Tones Text Transfer Language (RTTTL) file format specification

```

<name> <sep> [<defaults>] <sep> <note-command>+
<name> := <char>+ ; max length 10 characters      PICAXE accepts up to 50
<sep> := “:”
<defaults> :=
<def-note-duration> | <def-note-scale> | <def-beats>
<def-note-duration> := “d=” <duration>
<def-note-octave> := “o=” <octave>
<def-beats> := “b=” <beats-per-minute>

; If not specified, defaults are
; duration = 4 (quarter note)
; octave = 6
; beats-per-minute = 63 (decimal value)          PICAXE defaults to 62

<note-command> :=
[<duration>] <note> [<octave>] [<special-duration>] <delimiter>

<duration> :=
”1” |           ; Full 1/1 note
”2” |           ; 1/2 note
”4” |           ; 1/4 note
”8” |           ; 1/8 note
”16” |          ; 1/16 note          Not used – PICAXE changes to 8
”32” |          ; 1/32 note          Not used – PICAXE changes to 8

<note> :=
”C” |
”C#” |
”D” |
”D#” |
”E” |
”F” |
”F#” |
”G” |
”G#” |
”A” |
”A#” |
”B” |           ; “H” can also be used      PICAXE exports using B
”P” |           ; pause

<octave> :=
”5” |           ; Note A is 440Hz
”6” |           ; Note A is 880Hz
”7” |           ; Note A is 1.76 kHz
”8” |           ; Note A is 3.52 kHz        Not used - PICAXE uses octave 7

<special-duration> :=
”.” |           ; Dotted note          Not used - PICAXE rounds down

<delimiter> := “,”

```

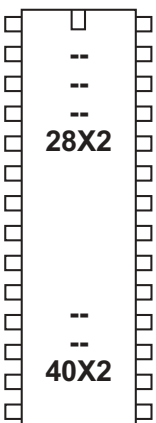
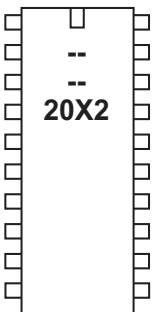
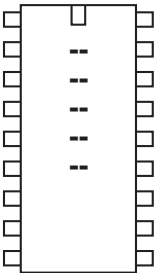
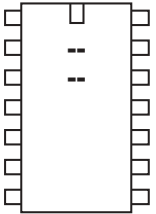
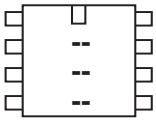
uniin

Syntax:

UNIIN pin, device, command, (var, var...)

UNIIN pin, device, command, address, address, (var, var...)

- pin is a variable/constant which specifies the i/o pin to use.
- device is the UNI/O type, %10100000 for EEPROM devices
- command is the read type command, either

UNI_READ	Read from specified address
UNI_CRRD	Read from current address
UNI_RDSR	Read status byte
- address is the optional 2 byte address, only used by UNI_READ
- variable receives the data.

e.g.

```
uniin C.3, %10100000, UNI_RDSR, (b1)
uniin C.3, %10100000, UNI_CRRD, (b1,b2,b3)
uniin C.3, %10100000, UNI_READ, 0, 1, (b1,b2,b3)
```

Function:

Read data from the UNI/O device into the PICAXE variable.

Information:

The 'uniin' command allows data to be read in from an external UNI/O part such as the 11LCxxx series EEPROM chips. UNI/O parts only require one i/o pin to connect to the PICAXE microcontroller. A 4k7 pullup resistor is not required by the UNI/O specification, but is highly recommended.

This command cannot be used on the following pins due to silicon restrictions:

20X2 C.6 = fixed input

Example:

Please see the uniout command overleaf.

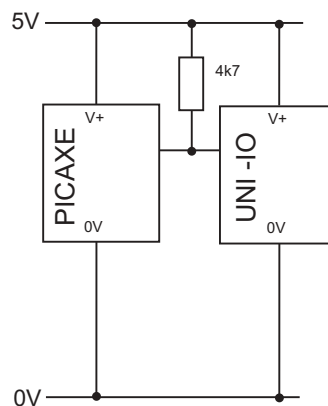

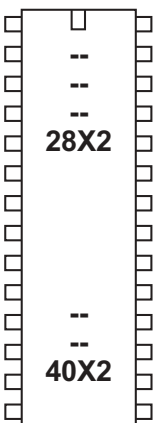
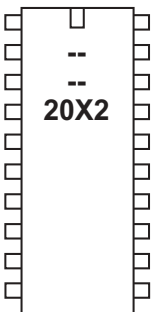
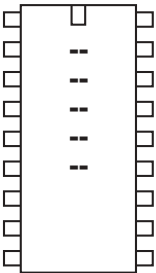
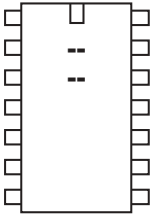
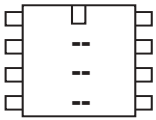

uniout

Syntax:

UNIOUT pin, device, command

UNIOUT pin, device, command, (data)

UNIOUT pin, device, command, address, address, (data, data..)

- pin is a variable/constant which specifies the i/o pin to use.
- device is the UNI/O type, %10100000 for EEPROM devices
- command is the write type command, either

UNI_WRITE	write
UNI_WREN	write enable
UNI_WRDI	write disable
UNI_WRSR	write status
UNI_ERAL	erase all
UNI_SETAL	set all

- address is the 2 byte address required by UNI_WRITE
- data is the information to write

e.g.

```
uniout C.3, %10100000, UNI_ERAL
uniout C.3, %10100000, UNI_SETAL
uniout C.3, %10100000, UNI_WREN
uniout C.3, %10100000, UNI_WRSR, (%0011)
uniout C.3, %10100000, UNI_WRITE, 0, 1, (b1)
uniout C.3, %10100000, UNI_WRDI
```

Function:

Write data to the UNI/O device. Note that the UNI/O parts have a 16 byte page boundary. A single write cannot go over a page boundary (ie a multiple of 16). This means, for instance, you may write 10 bytes in one UNI_WRITE command from address 0 up, but not 10 bytes from address 10 upwards, as this would overlap a page boundary (byte 16).

Information:

The 'uniout' command allows data to be written to an external UNI/O part such as the 11LCxxx series EEPROM chips. UNI/O parts only require one i/o pin to connect to the PICAXE microcontroller.

A 4k7 pullup resistor is not technically required by the UNI/O specification, but is highly recommended.

Note that when first powered up (after a power-on or brown out reset) the UNI/O device is in a special low-power standby mode. It is necessary to 'wake' the device, via a rising edge pulse (using the pulsout command), before the uniin / uniout commands will function correctly.

This command cannot be used on the following pins due to silicon restrictions:
20X2 C.6 = fixed input

Example:

```

reset_uni:
    pulsout C.3, 1                ; ESSENTIAL - enable device
                                   ; via a rising edge pulse

main:
    inc b1
    uniout C.3, %10100000, UNI_WRSR, (0)    ; clear status
    uniout C.3, %10100000, UNI_WREN        ; write enable
    uniout C.3, %10100000, UNI_WRITE, 0, 1, (b1) ; write
    pause 10                               ; wait for write
    uniout C.3, %10100000, UNI_WRDI        ; write disable
    pause 1000                              ; wait
    uniin C.3, %10100000, UNI_READ, 0, 1, (b2) ; read
    debug                                   ; display
    goto main                               ; loop

```

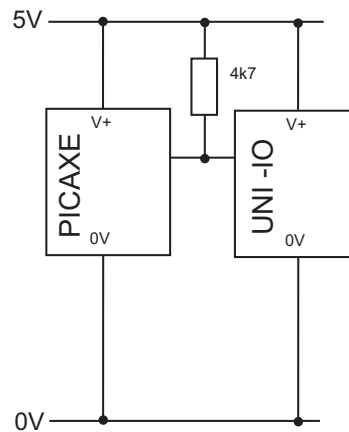

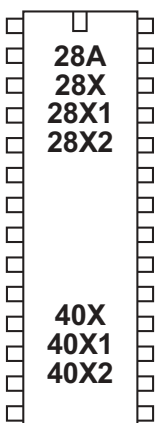
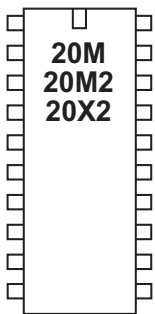
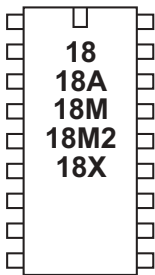
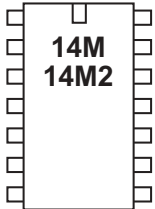
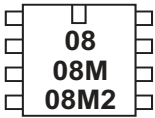

wait



Syntax:

WAIT seconds

- Seconds is a constant (1-65) which specifies how many seconds to pause.

Function:

Pause for some time in whole seconds.

Information:

This is a 'pseudo' command designed for use by younger students. It is actually equivalent to 'pause * 1000', ie the software outputs a pause command with a value 1000 greater than the wait value. Therefore this command cannot be used with variables. This command is not normally used outside the classroom.

Example:

main:

```

switch on B.7           ; switch on output B.7
wait 5                 ; wait 5 seconds
switch off B.7        ; switch off output B.7
wait 5                 ; wait 5 seconds
goto main              ; loop back to start

```

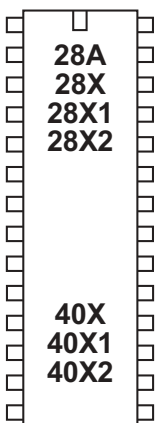
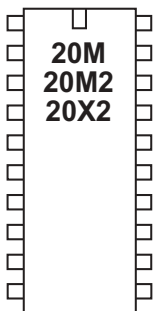
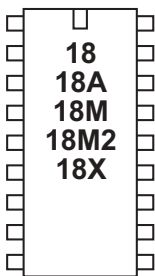
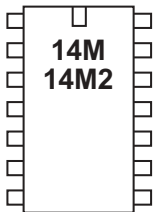
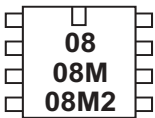

write



Syntax:

WRITE location,data ,data, **WORD** wordvariable...

- Location is a variable/constant specifying a byte-wise address (0-255).
- Data is a variable/constant which provides the data byte to be written. To use a word variable the keyword **WORD** must be used before the wordvariable.

Function:

Write byte data content into data memory.

Information:

The write command allows byte data to be written into the microcontrollers data memory. The contents of this memory is not lost when the power is removed. However the data is updated (with the EEPROM command specified data) upon a new download. To read the data during a program use the read command.

With the PICAXE-08, 08M, 08M2, 14M, 18, 18M and 18M2 the data memory is shared with program memory. Therefore only unused bytes may be used within a program. To establish the length of the program use 'Check Syntax' from the PICAXE menu. This will report the length of program. See the EEPROM command for more details.

When word variables are used (with the keyword **WORD**) the two bytes of the word are saved/retrieved in a little endian manner (ie low byte at address, high byte at address + 1)

Example:

```
main:
    for b0 = 0 to 63           ; start a loop
        serin C.6,N2400,b1    ; receive serial value
        write b0,b1          ; write value of b1 into b0
    next b0                   ; next loop
```

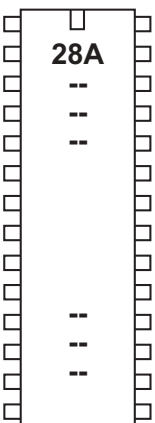
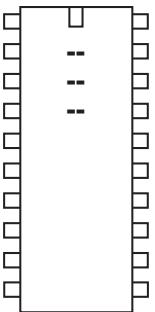
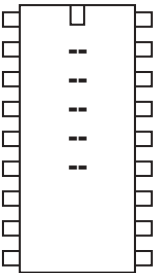
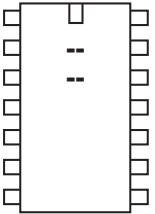
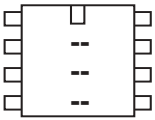

writemem

Syntax:

WRITEMEM location,data

- Location is a variable/constant specifying a byte-wise address (0-255).

- Data is a variable/constant which provides the data byte to be written.

Function:

Write FLASH program memory byte data into location.

Information:

The data memory on the PICAXE-28A is limited to only 64 bytes. Therefore the writemem command provides an additional 256 bytes storage in a second data memory area. This second data area is not reset during a download.

This command is not available on the PICAXE-28X as a larger i2c external EEPROM can be used.

The writemem command is byte wide, so to write a word variable two separate byte write commands will be required, one for each of the two bytes that makes the word (e.g. for w0, read both b0 and b1).

Example:

```
main:
    for b0 = 0 to 255      ; start a loop
        serin 6,N2400,b1 ; receive serial value
        writemem b0,b1   ; write value of b1 into b0
    next b0                ; next loop
```

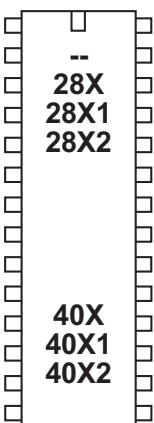
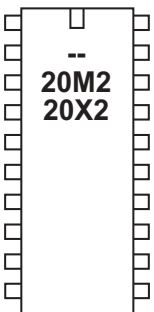
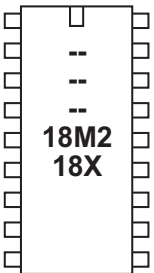
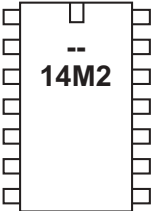
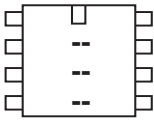

writei2c

This command is deprecated, please consider using the hi2cout command instead.

Syntax:

WRITE2C location,(variable,...)

WRITE2C (variable,...)

- Location is a variable/constant specifying a byte or word address.

- Variable(s) contains the data byte(s) to be written.

Function:

The writei2c (i2cwrite also accepted by the compiler) command writes variable data to the i2c location.

Information:

Use of i2c parts is covered in more detail in the separate 'i2c Tutorial' datasheet.

This command is used to write byte data to an i2c device. Location defines the start address of the data to be written, although it is also possible to write more than one byte sequentially (if the i2c device supports sequential writes).

Location must be a byte or word as defined within the i2cslave command. An i2cslave command must have been issued before this command is used.

Example:

```

; Example of how to use DS1307 Time Clock
; Note the data is sent/received in BCD format.
; Note that seconds, mins etc are variables that need
; defining e.g. symbol seconds = b0 etc.

; set DS1307 slave address
i2cslave %11010000, i2cslow, i2cbyte

;write time and date e.g. to 11:59:00 on Thurs 25/12/03
start_clock:
let seconds = $00 ; 00 Note all BCD format
let mins    = $59 ; 59 Note all BCD format
let hour    = $11 ; 11 Note all BCD format
let day     = $03 ; 03 Note all BCD format
let date    = $25 ; 25 Note all BCD format
let month   = $12 ; 12 Note all BCD format
let year    = $03 ; 03 Note all BCD format
let control = %00010000 ' Enable output at 1Hz

writei2c 0, (seconds,mins,hour,day,date,month,year,control)
end

```

Appendix 1 - Commands

adcconfig
backward, bcdtoascii, bcdtobin, bintoascii, bintobcd, booti2c, branch, button
calibadc, calibadc10, calibfreq, call, case, clearbit, compsetup, count
daclevel, dacsetup, data, debug, dec, disablebod, disabletime, disconnect, do,
doze
eeprom, else, elseif, enablebod, enabletime, end, endif, endselect, exit
for, forward, fvrsetup
get, gosub, goto
halt, hi2cin, hi2cout, hi2csetup, hibernate, high, hintsetup, hpwm, hpwmduty,
hpwmout, hserin, hserout, hsersetup, hshin, hshout, hspiin, hspiout, hspisetaup,
i2cread, i2cslave, i2cwrite, if, inc, infrain, infrain2, infraout, input, inputtype, irin,
irout
kbin, kbled, keyin, keyed
let, lookdown, lookup, loop, low
nap, next
on, output, owin, owout
pause, pauseus, peek, peeksfr, play, poke, pokesfr, pullup, pulsing, pulsout, put,
pwm, pwmduty, pwmout
random, read, readadc, readadc10, readdac, readdac10, readfirmware, readi2c,
readinternaltemp, readmem, readoutputs, readowclk, readownsn, readpinsc,
readportc, readrevision, readsilicon, readtable, readtemp, readtemp12, reconnect,
reset, resetowclk, restart, resume, return, reverse, rfin, rfout, run
select, sensor, serin, serout, serrxd, sertxd, servo, servopos, setbit, setfreq, setint,
setintflags, settimer, shiftin, shiftout, shin, shout, sleep, sound, spiin, spiout,
srlatch, srreset, srset, step, stop, suspend, swap, switch, switchoff, switchon,
symbol
table, tablecopy, tmr3setup, toggle, togglebit, touch, touch16, tune
uniin, uniout, until
wait, while, write, writei2c, writemem

Appendix 2 - Additional (non-command) reserved words

a, a.0-a.7, adcsetup, adcsetup2, and, andnot, atan
b, b.0-b.7, b0-b55, b300_4, b300_8, b300_16, b300_20, b300_32, b300_40, b300_64, b600_4, b600_8, b600_16, b600_20, b600_32, b600_40, b600_64, b1200_4, b1200_8, b1200_16, b1200_20, b1200_32, b1200_40, b1200_64, b2400_4, b2400_8, b2400_16, b2400_20, b2400_32, b2400_40, b2400_64, b4800_4, b4800_8, b4800_16, b4800_20, b4800_32, b4800_40, b4800_64, b9600_4, b9600_8, b9600_16, b9600_20, b9600_32, b9600_40, b9600_64, b14400_4, b14400_8, b14400_16, b14400_20, b14400_32, b14400_40, b14400_64, b19200_4, b19200_8, b19200_16, b19200_20, b19200_32, b19200_40, b19200_64, b28800_4, b28800_8, b28800_16, b28800_20, b28800_32, b28800_40, b28800_64, b31250_4, b31250_8, b31250_16, b31250_20, b31250_32, b31250_40, b31250_64, b38400_4, b38400_8, b38400_16, b38400_20, b38400_32, b38400_40, b38400_64, b57600_4, b57600_8, b57600_16, b57600_20, b57600_32, b57600_40, b57600_64, b76800_4, b76800_8, b76800_16, b76800_20, b76800_32, b76800_40, b76800_64, b115200_4, b115200_8, b115200_16, b115200_20, b115200_32, b115200_40, b115200_64, bit, bit0-bit31, bptr, bptr0-bptr7, @bptr, @bptrdec, @bptrinc
c, c.0-c.7, clear, cls, compflag, compvalue, cos, cr
d, d.0-d.7, dcd, dig, dir0-dir7, dira.0-dira.7, dirb.0-dirb.7, dirc.0-dirc.7, dird.0-dird.7, dirs, dirsa, dirsb, dirsc, dirsd
em4, em8, em16, em20, em32, em40, em64
flag0-flag15, flags, flagsh, flagsl, fvr1024, fvr2048, fvr4096
hi2cflag, hi2clast, hint0flag, hint1flag, hint2flag, hintflag, hserinflag, hserinptr, hserptr
i2cbyte, i2cfast, i2cfast_4, i2cfast_8, i2cfast_16, i2cfast_20, i2cfast_32, i2cfast_40, i2cfast_64, i2cfast4, i2cfast8, i2cfast16, i2cfast20, i2cfast32, i2cfast40, i2cfast64, i2cmaster, i2cslow, i2cslow_4, i2cslow_8, i2cslow_16, i2cslow_20, i2cslow_32, i2cslow_40, i2cslow_64, i2cslow4, i2cslow8, i2cslow16, i2cslow20, i2cslow32, i2cslow40, i2cslow64, i2cword, infra, input0-input7, inv, is, it_5v0, it_4v5, it_4v0, it_3v5, it_3v3, ir_3v0, ir_raw_h, it_raw_l
k31, k62, k125, k250, k500, keyvalue
lf, lsbfirst, lsbfirst_h, lsbfirst_l, lsbpost, lsbpost_h, lsbpost_l, lsbpre, lsbpre_h, lsbpre_l
m1, m2, m4, m8, m16, m32, m64, max, min, mod, msbfirst, msbfirst_h, msbfirst_l, msbpost, msbpost_h, msbpost_l, msbpre, msbpre_h, msbpre_l
n300, n300_4, n600, n600_4, n600_8, n1200, n1200_4, n1200_8, n2400, n2400_4, n2400_8, n2400_16, n4800, n4800_4, n4800_8, n4800_16, n4800_32, n9600, n9600_8, n9600_16, n9600_32, n9600_64, n19200, n19200_16, n19200_32, n19200_64, n38400, n38400_32, n38400_64, n76800, n76800_64, nand, ncd, nob, nor, not
off, or, ornot, outpin0-outpin7, outpina.0-outpina.7, outpinb.0-outpinb.7, outpinc.0-outpinc.7, outpind.0-outpind.7, outpins, outpinsa, outpinsb, outpinc, outpinsd, output0-output7, ownoreset, ownoreset_bit, owresetafter, owresetafter_bit, owresetbefore, owresetbefore_bit, owresetboth, owresetboth_bit, owresetfirst, owresetfirst_bit
pin0-pin7, pina.0-pina.7, pinb.0-pinb.7, pinc.0-pinc.7, pind.0-pind.7, pins, pinsa, pinsb, pinsc, pinsd, port, porta, portb, portc, portd, pot, ptr, ptr0-ptr15, ptrh, ptrl, @ptr, @ptrdec, @ptrincpwmdiv16, pwmdiv4, pwmdiv64, pwmfull_f, pwmfull_r, pwmhalf, pwmhhhh, pwmhlhl, pwmlhll, pwmsingle

rev
 s_w0-s_w7, sensor, set, sin, spifast, spimedium, spimode00, spimode00e,
 spimode01, spimode01e, spimode10, spimode10e, spimode11, spimode11e,
 spislow, sqr, step
 t300, t300_4, t600, t600_4, t600_8, t1200, t1200_4, t1200_8, t2400, t2400_4,
 t2400_8, t2400_16, t4800, t4800_4, t4800_8, t4800_16, t4800_32, t9600,
 t9600_8, t9600_16, t9600_32, t9600_64, t19200, t19200_16, t19200_32,
 t19200_64, t38400, t38400_32, t38400_64, t76800, t76800_64, t1s_4, t1s_8,
 t1s_16, t1s_20, t1s_32, t1s_40, t1s_64, task, then, time, timer, timer3, to, toflag,
 trisc
 uni_crrd, uni_eral, uni_rdsr, uni_read, uni_setal, uni_wrdr, uni_wren, uni_write,
 uni_wrsr, until
 w0-w27, while, word
 xnor, xor, xornot

Appendix 3 - Reserved Labels

The following labels have special meanings and are reserved for use with that specific purpose only:

interrupt:	(interrupts - see setint command)
start0:, start1:, start2:, start3: start4:, start5:, start6:, start7:	(parallel tasks - see restart command)

Appendix 4 - Possible Conflicting Commands

Internal Interrupt Driven Event Tasks

<i>Task:</i>	<i>Internal Interrupt:</i>	<i>Command:</i>
Background serial receive	Serial interrupt	hserssetup
Background I2C slave mode	I2C interrupt	hi2csetup
Timer	Timer 1 interrupt	settimer
Servo	Timer 1 & 2 interrupts	servo
Timer 3	Timer 3 interrupt	tmr3setup
Hardware pin interrupt	Hardware pin interrupt	hintsetup
Comparator	Comparator interrupt	compsetup

The PICAXE functions above make use of internal event based interrupt tasks to process correctly. Internal event tasks temporarily 'pause' the main program processing to process the task as and when it occurs. This is not normally noticed by the end user as the tasks are fully automated and very quickly processed.

However this system can cause potential issues on timing sensitive commands such as those using serial or one-wire communication. If the event were to occur during the timing sensitive command, the command would become corrupt as the timing would be altered and hence incorrect data would be sent in/out of the PICAXE chips. Therefore the following commands must temporarily disable all interrupts whilst processing:

Serial:	serin, serout, serrxd, sertxd, debug
One-wire:	owin, owout, readtemp, readtemp12, readown
UNI/O:	uniin, uniout
Infra-red:	infraout, irout

Note that other timing commands (e.g. count, pulsing, pulsingout etc.) do not disable the interrupts, but, if active, the hardware interrupt processing time may affect the accuracy of these commands when they are processed.

The user program must work around this limitation of the microcontroller.

Frequency Dependent Internal Background Tasks

<i>Task:</i>	<i>Internal Module:</i>	<i>Commands:</i>
PWM	Timer 2 & pwm	pwmout / hpwm
Background serial receive	Serial receive	hserssetup
Background I2C slave mode	I2C receive	hi2csetup
Servo	Timer 1 & 2	servo
Timer	Timer 1	settimer
Timer 3	Timer 3	tmr3setup

Note that these background tasks are frequency dependent. This has two main considerations:

- 1) Servo command cannot be used at the same time as pwm/hpwm/timer, as it also requires timers 1 and 2.
- 2) Some M2, X1 and X2 commands such as 'readtemp' automatically temporarily drop to the internal 4MHz resonator to process (to ensure correct operation of the timing sensitive command). When this occurs the background tasks may be affected - e.g. a pwmout waveform may temporarily change to a 4MHz waveform (if still enabled).

Appendix 5 - X2 Variations

Most X2 commands are supported on all of the parts in the X2 range.

However different variants of the PICAXE-X2 range have slightly different features and memory size. This is due to variants in the base PIC microcontroller used to generate the PICAXE chip. It is not possible for the PICAXE firmware to change these differences as they are physical hardware features of the PIC silicon design.

Feature	PICAXE Command	20X2	28X2	28X2 -5V	28X2 -3V	40X2	40X2 -5V	40X2 -3V
Base PIC micro (PIC18F series)		14K22	25K22	2520	25K20	45K22	4520	45K20
Voltage Range (V)		1.8-5.5	2.1-5.5	4.5-5.5	1.8-3.6	2.1-5.5	4.5-5.5	1.8-3.6
PICAXE Firmware Version Range		C.0+	B.3+	B.0-B.2	B.A-B.C	B.3+	B.0-B.2	B.A-B.C
Current (still in production) part		Yes	Yes	No	No	Yes	No	No
Max Internal Freq (MHz) Max External Freq (MHz)	setfreq	64 n/a	16 64	8 40*	16 64	16 64	8 40*	16 64
Touch Sensor Support	touch	No	Yes	No	No	Yes	No	No
ADC Setup seq. or individual.	adcsetup	ind.	ind.	seq.	ind.	ind.	seq.	ind.
Internal ADC reference (V)	calibadc	1.024	1.024	No	1.2	1.024	No	1.2
Variables RAM (bytes)	peek, poke @bptr	128	256	256	256	256	256	256
Scratchpad RAM (bytes)	put, get @ptr	128	1024	1024	1024	1024	1024	1024
Internal Program slots External Program slots	run	1 32	4 32	4 32	4 32	4 32	4 32	4 32
Hardware Interrupt pins	hintsetup	2	3	3	3	3	3	3
Pwmout channels	pwmout	1	4	2	2	2	2	2
hpwm support	hpwm	Yes	Yes	No	Yes	Yes	Yes	Yes
power steering mode within hpwm	hpwm	Yes	Yes	No	Yes	Yes	No	Yes
pullups individually controller	pullup	Yes	Yes	No	Yes	Yes	No	Yes
SRLatch, FVR and DAC modules	srlatch, fvrsetup dacsetup	Yes	Yes	No	No	Yes	No	No

* 32MHz (8MHz resonator with x4 PLL) is recommended for programs using serial commands as 40MHz is not an even multiple of 8 and so does not produce valid serial baud rates.

Appendix 6 - M2 Variations

Most M2 commands are supported on all of the parts in the M2 range. However different variants of the PICAXE-M2 range have slightly different features and memory size as shown below. This is due to variants in the base PIC microcontroller used to generate the PICAXE chip. It is not possible for the PICAXE firmware to change these differences as they are physical hardware features of the PIC silicon design.

Feature	PICAXE Command	08M2	18M2	18M2+	14M2	20M2
Voltage Range (V)		2.3-5.5	1.8-5.5	1.8-5.5	1.8-5.5	1.8-5.5
Memory Capacity (bytes)		2048	2048	2048	2048	2048
Parallel Tasks (starts)	resume, suspend	4	4	8	8	8
Max Internal Freq (MHz)	setfreq	32	32	32	32	32
Variables RAM (bytes)	peek, poke @ bptr	128	256	512	512	512
Table data (bytes)	table, readtable, tablecopy	-	-	512	512	512
I2C master support	hi2cin, hi2cout, hi2csetup	Yes	Yes	Yes	Yes	Yes
Pwmout channels	pwmout	1	2	2	4	4
Hpwm support	hpwm	No	No	No	Yes	Yes
Keyboard support	kbin, kbled	No	No	Yes	Yes	Yes
RF radio support	rfin, rfout	No	No	Yes	Yes	Yes
Internal temp. sensor	readinternal-temp	Yes	No	Yes	Yes	Yes
Configurable input type	inputtype	No	No	No	Yes	Yes

Manufacturer Website:

Main website: www.picaxe.com
Forum: www.picaxeforum.co.uk
VSM Simulator: www.picaxeism.com

PICAXE products are developed and distributed by
Revolution Education Ltd
<http://www.rev-ed.co.uk/>

Trademark:

PICAXE® is a registered trademark licensed by Microchip Technology Inc.
Revolution Education is not an agent or representative of Microchip
and has no authority to bind Microchip in any way.

Acknowledgements:

Revolution Education would like to thank the following:

Clive Seager
John Bown
LTScotland
Higher Still Development Unit
UKOOA

Mike Meakin of Nikam Electronics who kindly donated the firmware for the NKM2401 which is used within the rfin and rfout commands and the AXE213 project kit.