

Drawing Circles and curves – 10DVC course

1- Introduction to circles and drawing tools:

Circles

Here are the names and symbols you need to know about when drawing circles. Note the broken line (CENTRE LINE) through the middle.

Diameter

Is the distance from one side to the other, through the centre.

Your compass must always be set to half the diameter (radius).

The diameter is indicated on a drawing by the following symbol: \varnothing ie; $\varnothing 50$

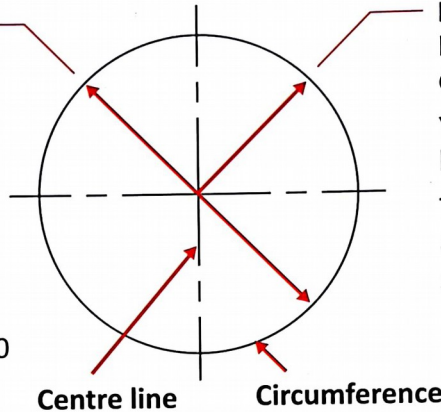

Radius

Is the distance from the centre to circumference.

Your compass must always be set to the radius.

The radius is indicated on a drawing by the following symbol: R ie; R25

The Compass



Sharpening

Sharpen the lead on an angle, on the outside edge, on fine sandpaper. Use an HB lead.

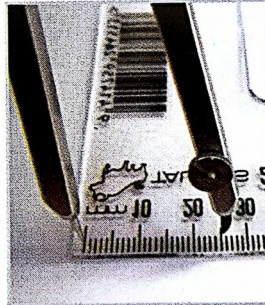

Setting

Place your ruler or set square flat on your desk with the numbered side facing you. You can make a small hole for the compass point to locate into the plastic at the first millimetre mark, then open the leg to the required distance.

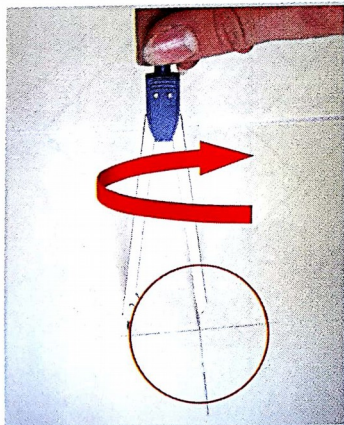

Holding and Using

Draw the centre lines first, as very light construction lines. Where they meet is the place to rest the point of the compass.

Hold the compass between your forefinger and thumb. Lean it on a slight angle away from you and twist it in the direction of the arrow, **drawing the curve only once**. Begin and end the curve at the same place on the centre line. Practise drawing some circles on a piece of scrap paper.

Exercise-1: Six Shooter

1. Draw a horizontal and vertical centre line.
2. Scribe a 25 mm radius circle.
3. Scribe a 50 mm radius circle.
4. Scribe a 50 mm radius arc from point A to intersect the 50 mm radius circle above and below the horizontal line.

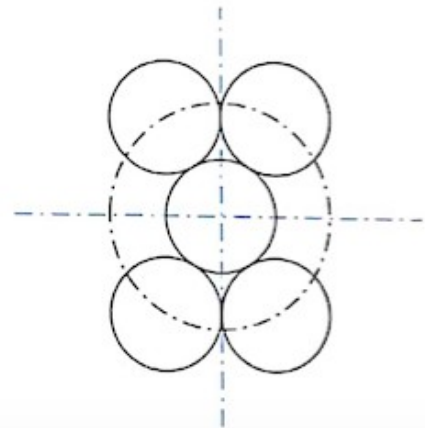
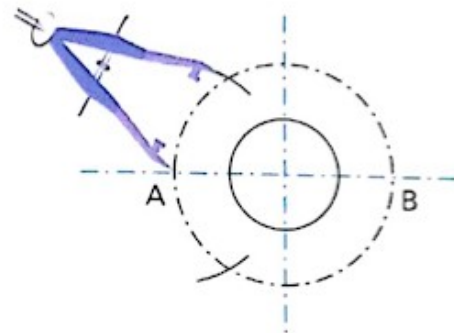
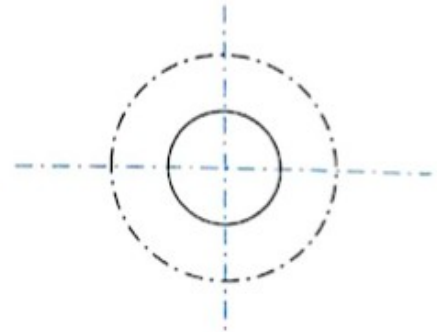

5. Repeat step 4 from point B.
6. Scribe four circles at a radius of 25 mm.
7. Scribe a 25 mm radius arc from point A and B.
8. Scribe a 75 mm circle to encompass all 7 circles.

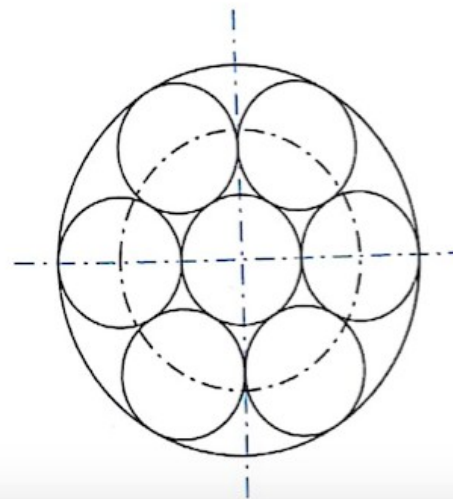
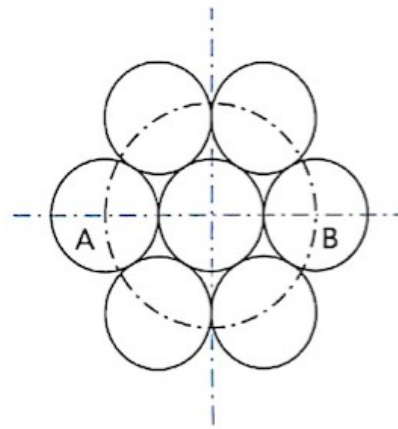

Exercise-2: Audi Car Logo

Draw the car logo. Set your compass to R30 and R40.

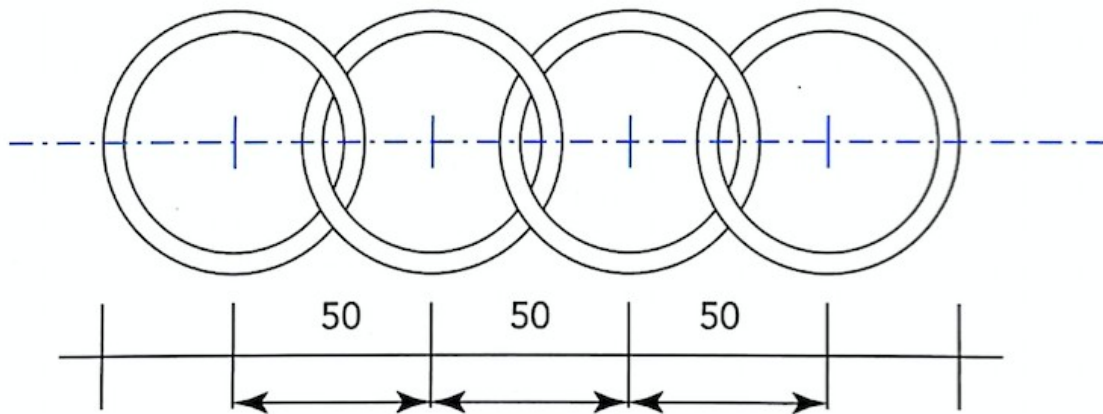

Exercise-3: Cosmic Logo

Draw the cosmic logo. Set your compass to R60 and R15.

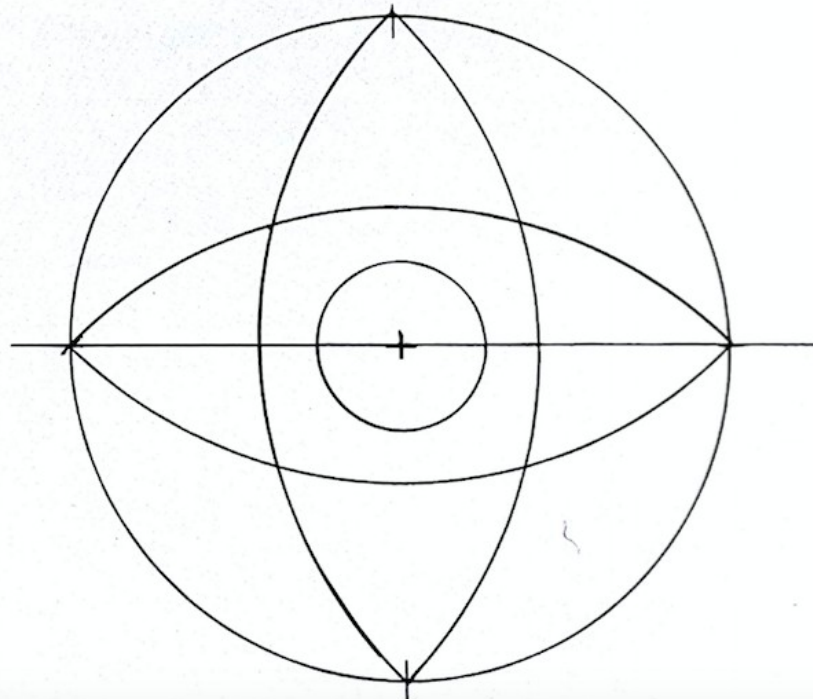

Exercise-4: British Paint Logo

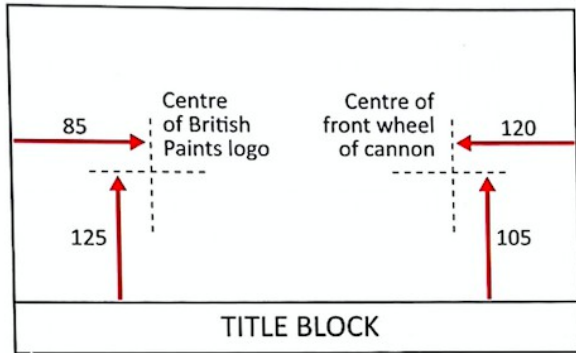

- 1 Prepare a new title block COMPASS EXERCISES. Use the page layout shown, drawing the centre lines first as construction lines.
- 2 With a sharp compass, a 2H pencil and your instruments, redraw the British Paints logo and the Toy Cannon.
- 3 Use colouring pencils and your 4B pencil to render the Toy Cannon.

British Paints Logo

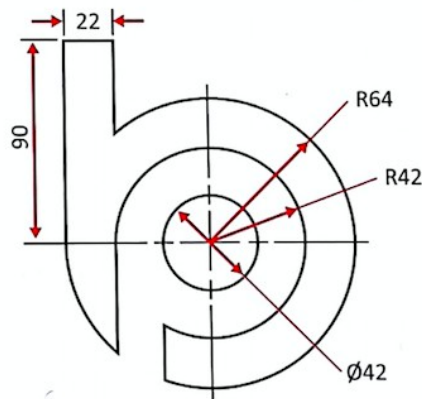

Exercise-5: Roundabout Square

Draw the roundabout square. Set your compass to R60.

